



TRIO  
LIGHTING FOR YOU



20  
25

# HERZLICH WILLKOMMEN!

## WELCOME!

„Leuchten sind weit mehr als nur funktionale Objekte – sie prägen unsere Umgebung und verbessern unsere Lebensqualität. Ob elegante Stehleuchte im Wohnzimmer oder praktische Schreibtischlampe im Arbeitszimmer, Leuchten sind unverzichtbare Begleiter in unserem Alltag. Mit unserer umfassenden Expertise und unserem unermüdlichen Innovationsgeist setzen wir neue Maßstäbe und bieten ein breites Spektrum an Beleuchtungslösungen. Dabei stehen Qualität, Kundenzufriedenheit und Nachhaltigkeit stets im Mittelpunkt unseres Handelns.“

"Lights are far more than just functional objects - they characterise our surroundings and improve our quality of life. Whether it's an elegant floor lamp in the living room or a practical desk lamp in the study, lights are indispensable companions in our everyday lives. With our extensive expertise and tireless spirit of innovation, we set new standards and offer a wide range of lighting solutions. Quality, customer satisfaction and sustainability are always at the centre of everything we do."



### UNSERE VISION OUR VISION

„Unser Ziel ist es, durch innovative und effiziente Beleuchtungslösungen, das Leben der Menschen heller und lebenswerter zu gestalten.“

"Our goal is to make people's lives brighter and more liveable through innovative and efficient lighting solutions."



**350**  
MITARBEITER\*  
INNEN  
EMPLOYEES

**5.000 m<sup>2</sup>**  
BÜROFLÄCHE  
OFFICE SPACE

**35.000 m<sup>2</sup>**  
LOGISTIKFLÄCHE  
LOGISTICS SPACE

**48.000**  
PALETTENPLÄTZE  
PALETT BAYS

**1.300 m<sup>2</sup>**  
SHOWROOM



## UNSER TEAM OUR TEAM

Die TRIO Lighting Group beschäftigt rund 350 hochqualifizierte Mitarbeiter\*innen, die sich täglich dafür einsetzen, unseren Kund\*innen innovative Produktideen und exzellenten Service zu bieten. Bei uns bleibt kein Wunsch unerfüllt.

The TRIO Lighting Group employs around 350 highly qualified employees who are committed to providing our customers with innovative product ideas and excellent service every day. No wish remains unfulfilled with us.



## UNSER SORTIMENT OUR ASSORTMENT

Unser Sortiment reicht von energieeffizienten und langlebigen modernen LED-Leuchten über stilvolle dekorative Leuchten, die jedem Raum Eleganz und Charme verleihen, bis hin zu robusten, wetterfesten Leuchten für den Außenbereich.

Our product range extends from energy-efficient and long-lasting modern LED lights to stylish decorative lights that add elegance and charm to any room and robust, weatherproof lights for outdoor use.



## UNSERE LOGISTIK OUR LOGISTIC

“In der heutigen schnelllebigen Geschäftswelt ist unser Logistikzentrum von zentraler Bedeutung. Mit einer beeindruckenden Fläche von über 35.000 Quadratmetern und einer Lagerkapazität von rund 48.000 Palettenplätzen bildet es das Rückgrat unserer Geschäftsprozesse. Es steht als Symbol für unsere Verpflichtung, erstklassigen Service zu bieten und eine zuverlässige sowie pünktliche Lieferung sicherzustellen.”

"In today's fast-paced business world, our logistics centre is of central importance. With an impressive area of over 35,000 square metres and a storage capacity of around 48,000 pallet spaces, it forms the backbone of our business processes. It symbolises our commitment to providing a first-class service and ensuring reliable and punctual delivery."





## **Klimaschutz durch Aufforstung: Wir pflanzen Zukunft**

Mit dem Projekt „WaldLokal“ wurde im Regierungsbezirk Arnsberg ein regionales Wiederaufforstungsprojekt ins Leben gerufen, an dem sich Firmen wie die TRIO Lighting Group seit 2023 beteiligen. Wiederaufforstung ist ein entscheidender Schritt im Kampf gegen den Klimawandel und den Verlust der Biodiversität. Durch das Pflanzen neuer Bäume auf abgeholzten oder degradierten Flächen können wir nicht nur den CO<sub>2</sub>-Gehalt in der Atmosphäre reduzieren, sondern auch Lebensräume für zahlreiche Tier- und Pflanzenarten wiederherstellen.

**„Wir sind dabei, wenn es darum geht, in unseren Wäldern neue Wurzeln für eine nachhaltige Zukunft zu schlagen.“**

## **Climate protection through reforestation: we are planting the future**

With the „WaldLokal“ project, a regional reforestation project was launched in the Arnsberg administrative district, in which companies such as the TRIO Lighting Group have been participating since 2023. Reforestation is a crucial step in the fight against climate change and the loss of biodiversity. By planting new trees on deforested or degraded areas, we can not only reduce the CO<sub>2</sub> content in the atmosphere, but also restore habitats for numerous animal and plant species.

**„We are there when it comes to putting down new roots in our forests for a sustainable future.“**



# **GEMEINSAM**

## **für eine bessere Lebensqualität**

In einer Welt, die zunehmend von Umweltproblemen und Klimawandel betroffen ist, ist es wichtiger denn je, gemeinsam zu handeln, um unsere Umwelt zu schützen und die Lebensqualität für zukünftige Generationen zu sichern. Wir möchten unseren Beitrag leisten, indem wir umweltfreundliche Maßnahmen ergreifen, nachhaltige Innovationen fördern sowie die Unterstützung lokaler Gemeinschaften vorantreiben, die sich für den Umweltschutz und die Nachhaltigkeit einsetzen.

Wir streben nach langfristigem Erfolg, der im Einklang mit unseren ökologischen und sozialen Zielen steht. Dies erreichen wir durch verantwortungsbewusste Geschäftspraktiken, ethisches Verhalten und Transparenz in all unseren Aktivitäten. Wir sind überzeugt, dass nachhaltiger Erfolg nur durch umweltbewusstes und verantwortungsvolles Handeln möglich ist. Gemeinsam mit den Menschen, die unsere Produkte herstellen, und jenen, die sie nutzen, können wir die bevorstehenden Herausforderungen meistern.

# **WORKING TOGETHER**

## **for a better quality of life**

In a world increasingly affected by global problems and climate change, it is more important than ever to act together to protect our environment and safeguard the quality of life for future generations. We want to do our part by taking green measures, promoting sustainable innovation and supporting local communities that are committed to environmental protection and sustainability.

We strive for long-term success that is in line with our environmental and social goals. We achieve this through responsible business practices, ethical behaviour and transparency in all our activities. We are convinced that sustainable success is only possible through environmentally conscious and responsible behaviour. Together with the people who manufacture our products and those who use them, we can overcome the challenges that lie ahead.

*We are stronger together*

# Nachhaltig handeln, Zukunft gestalten

## JEDER BEITRAG ZÄHLT



### Effizient und umweltfreundlich

Die LED-Technologie hat sich als eine der umweltfreundlichsten Beleuchtungsoptionen etabliert. Alle unsere Produkte sind entweder mit energieeffizienten LEDs ausgestattet oder so konzipiert, dass sie problemlos mit LED-Leuchtmitteln kompatibel sind.

Für unsere GO GREEN-Produkte nutzen wir vorwiegend recycelte Materialien und nachwachsende Rohstoffe aus verantwortungsvoller, nachhaltiger Forstwirtschaft.

### Efficient and environmentally friendly

LED technology has established itself as one of the most environmentally friendly lighting options. All our products are either equipped with energy-efficient LEDs or designed to be easily compatible with LED light sources.

For our GO GREEN products, we primarily use recycled materials and renewable raw materials from responsible, sustainable forestry.



### Grüne Verpackungslösungen

Unsere Verpackungen bestehen zu 80% aus recycelten Materialien. Wir reduzieren bzw. vermeiden bewusst den Einsatz von Plastik in unseren Verpackungen. Stattdessen setzen wir auf umweltfreundliche Alternativen wie Papier, Karton und biologisch abbaubare Materialien. Dies hilft, die Verschmutzung durch Kunststoff zu reduzieren und die Umweltbelastung zu minimieren.

### Green packaging solutions

Our packaging consists of 80% recycled materials. We consciously reduce or avoid the use of plastic in our packaging. Instead, we rely on environmentally friendly alternatives such as paper, cardboard and biodegradable materials. This helps to reduce plastic pollution and minimise environmental impact.



### Saubere Energiegewinnung

Unsere PV-Anlage nutzt modernste Solarmodule, die Sonnenlicht effizient in elektrische Energie umwandeln. Die Anlage verfügt über eine Modulfläche von 12.000 qm und ermöglicht es uns, einen Großteil unseres Energiebedarfs durch erneuerbare Quellen zu decken und unseren CO<sub>2</sub>-Ausstoß erheblich zu reduzieren.

### Clean energy generation

Our PV system uses state-of-the-art solar modules that efficiently convert sunlight into electrical energy. The system has a module area of 12,000 square metres and enables us to cover a large part of our energy requirements from renewable sources and significantly reduce our CO<sub>2</sub> emissions.



# Acting sustainably, shaping the future

## EVERY CONTRIBUTION COUNTS



### E-Mobilität

Knapp die Hälfte unseres Fuhrparks wurde bereits auf Elektrofahrzeuge umgestellt. Für Mitarbeiter\*innen und Kund\*innen stehen 8 Ladestationen zur Verfügung. Durch die Kombination von E-Mobilität und erneuerbaren Energien leisten wir einen doppelten Beitrag zum Umweltschutz.

### E-mobility

Almost half of our vehicle fleet has already been converted to electric vehicles. There are 8 charging stations available for employees and customers. By combining e-mobility and renewable energies, we are making a double contribution to environmental protection.



### Digitaler Fortschritt

Unser digitaler Fortschritt zeigt, wie technologische Innovationen und Nachhaltigkeit Hand in Hand gehen können. Durch die Einführung von Home-Office-Regelungen, die Reduzierung des Papierverbrauchs, die Nutzung digitaler Kommunikationsmittel und einer nachhaltigen IT-Infrastruktur leisten wir einen weiteren Beitrag zum Umweltschutz und zur Effizienzsteigerung.

### Digital progress

Our digital progress shows how technological innovation and sustainability can go hand in hand. By introducing home office regulations, reducing paper consumption, using digital means of communication and a sustainable IT infrastructure, we are making a further contribution to protecting the environment and increasing efficiency.



### Soziale Verantwortung

Nachhaltigkeit bedeutet auch soziale und wirtschaftliche Verantwortung. Als verantwortungsbewusstes Unternehmen streben wir nicht nur wirtschaftlichen Erfolg an, sondern auch einen positiven gesellschaftlichen Beitrag. Faire Arbeitsbedingungen, wie angemessene Löhne, geregelte Arbeitszeiten, ein sicheres Arbeitsumfeld und Weiterbildungsmöglichkeiten, sind für uns selbstverständlich. Wir fördern Vielfalt und Inklusion und setzen auf ein respektvolles, unterstützendes Arbeitsklima.

### Social responsibility

Sustainability also means social and economic responsibility. As a responsible company, we strive not only for economic success, but also to make a positive contribution to society. Fair working conditions, such as appropriate wages, regular working hours, a safe working environment and training opportunities, are a matter of course for us. We promote diversity and inclusion and focus on a respectful, supportive working environment.

# Digital an Ihrer Seite.

Das digitale Erfolgselement  
für moderne Kommunikation –  
unser B2B-Portal myTRIO

# Digitally at your side.

The Digital Success Element  
for Modern Communication –  
our myTRIO B2B Portal



## Vorteile für registrierte Geschäftspartnerinnen und Geschäftspartner

Profitieren Sie von unserem schnellen und unkomplizierten Support! Mit nur einem Klick haben Sie Zugriff auf alle wichtigen Artikeldaten und können bequem Dateien herunterladen. Entdecken Sie diese Vorteile in unserem digitalen B2B-Portal myTRIO. Registrierte Nutzer finden dort alle relevanten Informationen zu unseren Produkten, von technischen Details bis hin zu Bildmaterial und Lagerbeständen. Sind Sie noch nicht registriert? Zögern Sie nicht, uns zu kontaktieren.

## Advantages for Registered Business Partners

Benefit from our fast and uncomplicated support! With just one click you have access to all important item data and can conveniently download files. Discover these advantages in our myTRIO digital B2B portal. Registered users will find all relevant information about our products there, from technical details to images and the amount of products in stock. You are not registered yet? Do not hesitate to contact us.

[my.trio-lighting.com](https://my.trio-lighting.com)



# Besuchen Sie uns auch bequem von Zuhause aus!

Tauchen Sie in die virtuelle Welt ein und erkunden Sie unseren Ausstellungsraum mit unserer interaktiven 360° Tour. Egal ob auf dem PC, Tablet oder Smartphone, der Rundgang steht Ihnen direkt im Webbrowser zur Verfügung. Besonders beeindruckend wird die Präsentation, wenn Sie eine VR-Brille verwenden. Weitere Informationen finden Sie auf unserer Webseite. Schauen Sie gerne vorbei und genießen Sie das Erlebnis. Viel Spaß!

# You Can Also Visit Us From the Comfort of Your Own Home!

Dive into the virtual world and explore our showroom with our interactive 360° tour. Whether on a PC, tablet or smartphone, the tour is available directly in your web browser. The presentation turns particularly impressive if you use VR glasses. You can find more information on our website. Feel free to stop by and enjoy the experience. Enjoy!



**Funktioniert auch mit VR-Brillen**  
**Also works with VR glasses**

[trio-lighting.com/showroom](http://trio-lighting.com/showroom)

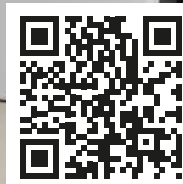

# INHALTSVERZEICHNIS

General Index · Index général · Algemene index ·  
Índice general · Indice generale · Index general · Yleisindeksi · Ogólny indeks

**36 GO GREEN**

**46 NATURE**

**100 DEKORATIVE LEUCHTEN-  
SERIEN & KOMBINATIONEN**  
DECORATIVE LIGHT SERIES &  
COMBINATIONS

**284 WAND- & DECKENLEUCHTEN**  
WALL & CEILING LAMPS

**394 STEH- & TISCHLEUCHTEN**  
FLOOR & TABLE LAMPS

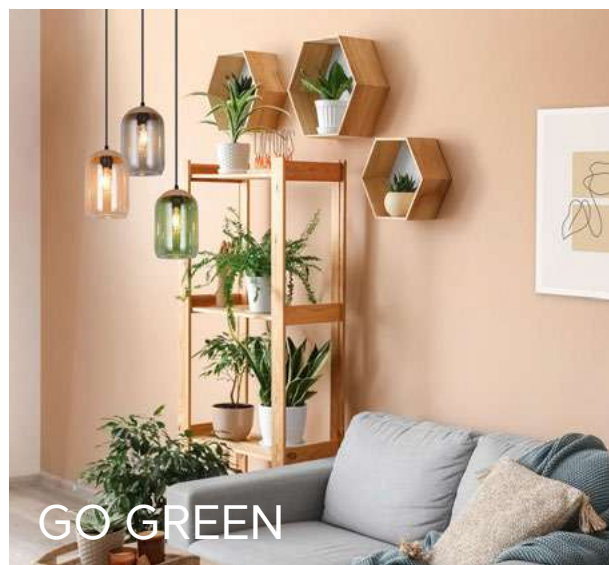



SPOTS



TRACK SYSTEM

460 SPOTS



WALL & CEILING

490 SCHIENENSYSTEM  
TRACK SYSTEM

512 EINBAULEUCHTEN  
RECESSED LIGHTS



BATHROOM

528 BADEZIMMERLEUCHTEN  
BATHROOM LIGHTING

562 LEUCHTMITTEL  
LIGHT SOURCES

584 SPEZIFIKATIONEN  
SPECIFICATIONS

# SERIENÜBERSICHT

Family overview · Aperçu par famille · Overzicht per familie · Vista general por familia ·  
Panoramica per famiglia · Prezentare pe familii de produse · Perheen yleiskuvaus · Przegląd rodziny

AARON	124	BOLDER	386	CURTIS	389	GALE	304
ADRIAN	360	BOLSA	540	DAKOTA	412	GALWAY	156
ADRIANO	379	BOOLAN	84	DARVIN	122	GANADO	329
AGRA	85	BRAD	86	DAVI II	448	GARDA	276
AGUDO	178	BRANTFORD	400	DEACON	98	GIADA	553
AKITA	294	BULLET	336	DELHI	70	GIANNI	546
ALBANY	118	BURTON	266	DIALLO	198	GILA	196
ALFIE	44	CALAIS	239	DIEGO	258	GIRONA	346
ALINO	393	CAMILLA	557	DISCALGO	240	GONZALO	358
AMBALA	462	CANIO	43	DIVA	212	GRANADA	302
AMSTERDAM	453	CARDONA	144	DIVO	361	GROOVY	310
ANGELO	538	CARRERA	133	DOHA	348	GUAYANA	466
APART	556	CARUSO	289	DOLOMITE	522	HARPER	88
ARGENTINA	408	CASSIO	430	DONNA	444	HARPER	88
ARGUS	519	CAYA	288	DOWNEY	316	HARRIS	66
ARINO	373	CELESTE	104	DURBAN	126	HEDDA	56
ARIZONA	405	CESAR	359	ECCO	393	HELIOS	162
AROSA	486	CHARIVARI	110	EDGE	116	HOSTEL	282
ARTURO	545	CHARLY	354	EDWARD	413	HOTEL	270
ARUNI	483	CHIRAZ	187	ELEMENT	380	HYDRA	318
ARVIN	330	CHIRON	186	ELIO	436	INDIRA	332
ARY II	449	CHIROS	368	ELISA	256	INGA	60
ASCARI	555	CHRIS	404	ELMAU	78	IRVINE	314
AURA	516	CLAAS	434	EMERALD	446	ISEO	76
AVA	452	CLAPTON	468	ENRICO	534	JANNE	51
BALDO	386	CLARIMO	554	FABIO	532	JIVE	138
BALE	439	CLAYTON	218	FABRIZIO	530	JOHANN	365
BALINI	226	CLEO	369	FACETTE	210	JOOST II	445
BANGKOK	407	COAT	371	FAIRFIELD	381	JORDAN	384
BARCA	93	COLINO	84	FERNANDO	322	JULIETA	280
BARON	154	COMFORT	383	FIATO	108	JURA	526
BARRIE	402	CONCHA	374	FILIGRAN	417	KAGAWA	294
BELFAST	166	CONDUS	559	FILO	261	KAMARA	192
BELL	68	COOKIE	320	FLEXO	459	KAPRUN	279
BELLARI	99	CORD	203	FLY	140	KARUNI	64
BERGAMO	418	CORE	514	FOMENTO	232	KAZAN	382
BERLIN	444	CORTEZ	278	FONTANA	90	KENAI	524
BISCUIT	321	CRISTO	449	FRANCIS	130	KERALA	96
BLAZE	114	CROSS	200	FRANKLIN	168	KHAN	74
BOCCIA	442	CRYSTEL	312	FRODENO	560	KORBA	72
BODRUM	337	CUADRO	388	FYNN II	447	KULA	543

LACAL	167	NAGANO	355	RISE	298	THEATRO	544
LACAPO	370	NANDINI	487	ROBIN	244	THIAGO	326
LANA	360	NANDOR	433	ROCCO	533	TILL II	448
LANCE	409	NARCOS	416	RODRIGO	73	TIRIAC	334
LEANO	367	NILAM	75	ROMA	362	TOBA	50
LEVISTO	249	NIMBUS	518	ROMINO II	242	TOKYO	351
LIGARA	391	NOLA	440	RONDO	136	TOSH	80
LILLY	362	NORIAKI	353	ROPE	202	TRACY	426
LINE	386	NORRIS	422	ROSS	264	TRADITIO	206
LINO	550	NUBIAN	440	RUNA	58	TRAJAN	158
LORELEY	243	NURIA	134	RUSTICA	204	TRAVELLER	424
LORENZO	552	OAKLAND	131	SALINAS	120	TRAVIS	450
LOUIS	370	ONYX	188	SAMURAI	356	TRAY	150
LUCERNA	236	OSAKA	352	SANDRINA	252	TREASURE	63
LUGANO	338	OXFORD	335	SANTO II	405	TUBULAR	148
LUGO	300	PAGO	482	SEASONS	77	TUCSON	324
LUIS II	446	PAMIR	520	SEDONA	324	UMBERTO	556
LUMINA	220	PAOLO	560	SEEKER	415	VALENTE	238
LUNAR	357	PAPER	260	SEQUENCE	112	VAPORE	234
LUPO	455	PARIS II	432	SHANGHAI	406	VELA	436
LYON	428	PEACOCK	336	SHANTI	484	VENTURA	445
MADISON	172	PEBBLE	291	SHARP	472	VERONA	419
MANDALA	292	PERRY	456	SHOGUN	356	VIEW	547
MANDURO	451	PHOENIX	342	SIGNA	250	VINA	62
MANSUR	427	PIERA	536	SMILLA	52	VIOLA	259
MARIO	384	PIRIN	522	SORAYA	194	WACO	344
MARLEY	182	PLANT	61	SORRENTO	323	WALES	378
MARNIE	128	PLATON	378	SPIRELLI	254	WANDA	390
MARRIOT	385	POLO	454	SPLIT	404	WILLIS	396
MATARO	216	PRONTO	458	STAMINA	248	WINONA	328
MATS II	438	PURA	361	STANLEY	246	XAVI	558
MATTIMO	548	PURE	228	STEEN	443	YAVA	317
MEDERA	308	QUEBEC	398	STREAM	180	YUMA	340
MELBY	331	QUINTA	364	SVEA	54	ZAGROS	521
MERTON	174	RAGLAN	376	SYDNEY	132	ZANDOR	152
MIKO	350	RAHUL	94	TAJO	459	ZAZOU	362
MIO	366	RAMA	92	TAMIL	199	ZENO	286
MITA	295	RAMON	392	TARA	42	ZIVA	193
MONTILLA	306	RAVEN	372	TARIFA	222	ZODIAC	290
MONZA	420	RAY	542	TAURUS	464	ZUCCA	258
MORGAN	296	RILA	523	TEXEL	414		

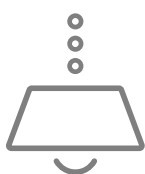

# PENDELLEUCHTEN & KRONEN

Pendants & chandeliers · Lustres & suspensions · Hanglampen & kroonluchters ·  
Colgantes y Lámparas · Lampadari e sospensioni · Lustre si pendule · Riippu- & kruunu ·  
Wiszące i żyrandole



DARVIN 122



MARNIE 128



NURIA 134

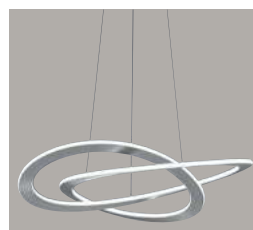

OAKLAND 131

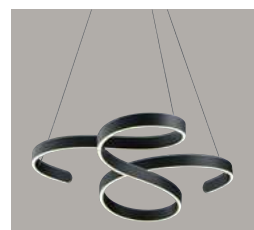

FRANCIS 130



CARDONA 144



TRAY 150



FLY 140



CARRERA 133

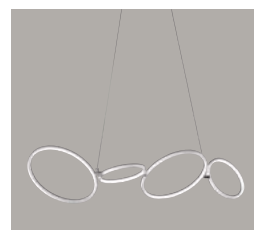

RONDO 136



ALBANY 118

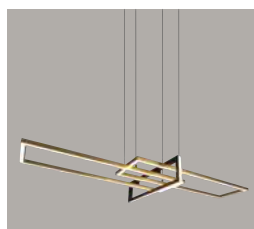

SALINAS 120



CHARIVARI 110



SEQUENCE 112



EDGE 116



GALWAY 156

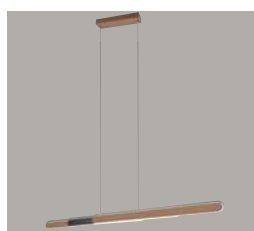

HELIOS 162

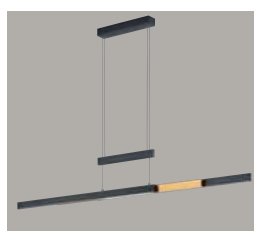

TRAJAN 158

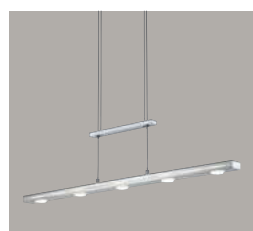

LACAL 167

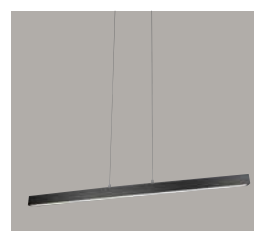

BELFAST 166



CELESTE 104



MADISON 172



FRANKLIN 168



BALINI 226



LUMINA 220



CORK 40



TARIFA 222



FACETTE 210



CLAYTON 218



PURE 228



VAPORE 234



VALENTE 238



DISCALGO 240



CALAIS 239



FOMENTO 232

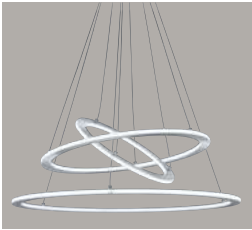

DURBAN 126

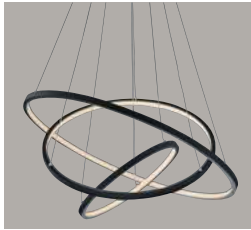

AARON 124

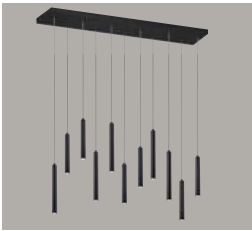

TUBULAR 148



FIATO 108



BLAZE 114



MARLEY 182



MERTON 174



MATARO 216



DIVA 212



ROBIN 244



STANLEY 246



LUCERNA 236



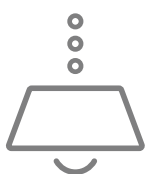

# PENDELLEUCHTEN & KRONEN

Pendants & chandeliers · Lustres & suspensions · Hanglampen & kroonluchters ·  
Colgantes y Lámparas · Lampadari e sospensioni · Lustre si pendule · Riippu- & kruunu ·  
Wiszące i żyrandole



BRAD 86



HARPER 88



TRAJAN 160



DEACON 98



KERALA 69



SMILLA 52



SVEA 54



JANNE 51



INGA 60



RUNA 58



TOSH 80



ELMAU 78



ROSS 264



JULIETA 280



GARDA 276



CORTEZ 279



LORELEY 243



HOTEL 272



HOSTEL 282



ROMINO II 242



GILA 169



SORAYA 194



ZIVA 193



KAMARA 192



ONYX 188



TAMIL 199



CROSS 200



CORD 203



ROPE 202



RUSTICA 204



SIGNA 250



SPIRELLI 254



ELISA 256



SANDRINA 252



STAMINA 248



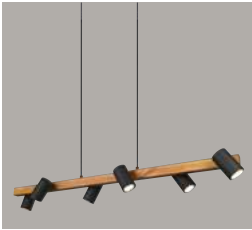

MARLEY 184



AGRA 85



BELL 68



DELHI 70



HARRIS 66



HEDDA 56



COLINO 84



BOOLAN 84



PLANT 61



BURTON 266



KAPRUN 279



BARON 154



ZANDOR 152



FILO 261



STREAM 180



CHIRAZ 187



CHIRON 186



AGUDO 178



TRADITIO 206



LEVISTO 249



VIOLA 259



DIEGO 258



ZUCCA 258



PAPER 260



# DECKENLEUCHTEN

Ceiling lamps · Plafonniers · Plafonnières · Plafones ·  
Plafoniere · Plafoniere · Kattvalaisimet · Plafony



MANDALA 292



PEBBLE 291



ZODIAC 290



MARNIE 128



CAYA 288



NURIA 134



FRANCIS 130



OAKLAND 131



CARRERA 133



YAVA 317



MONTILLA 306



GALE 304



RONDO 136



GROOVY 310



THIAGO 326



DARVIN 122



ALBANY 118

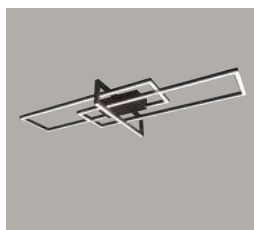

SALINAS 120



IRVINE 314

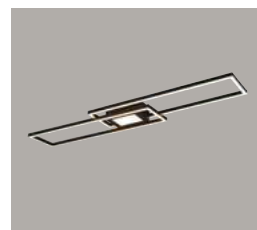

GANADO 329



SEDONA 324

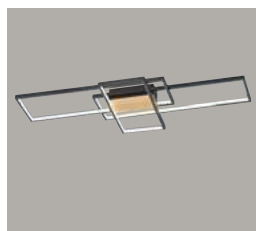

TUCSON 324



BARCA 93



RAMA 92



HARPER 88



FONTANA 90



BRAD 86



MEDERA 308



BELL 68



DEACON 98



HEDDA 56



SMILLA 52



SVEA 54



GRANADA 302



LUGO 300



CARUSO 289



CHARIVARI 110



JIVE 138



AARON 124

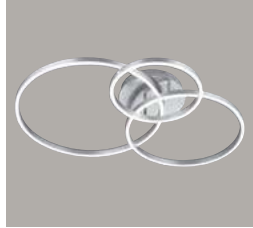

WINONA 328



ZENO 286

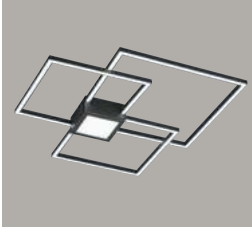

HYDRA 318



DOWNEY 316



FLY 140

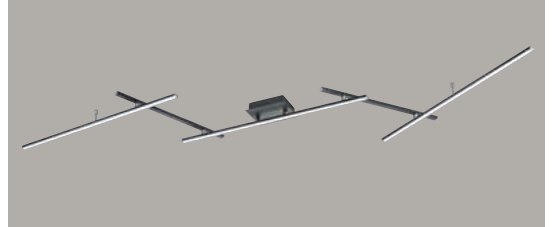

ARVIN 330

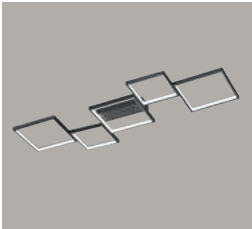

SORRENTO 323

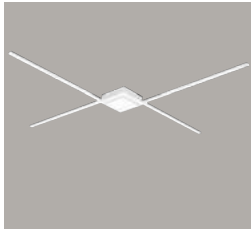

OXFORD 335

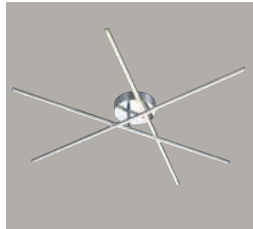

TIRIAC 334

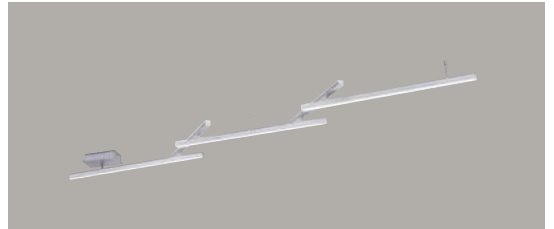

MELBY 331



SYDNEY 132



SEQUENCE 112

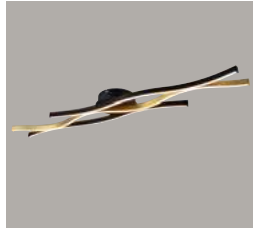

BLAZE 114

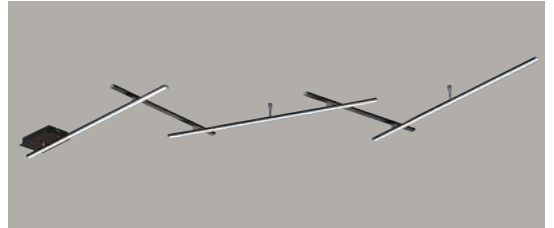

INDIRA 332



ISEO 76



ELMAU 78



SEASONS 77

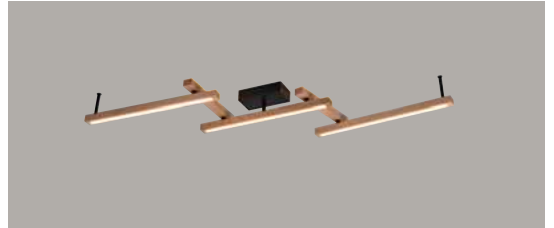

BELLARI 99



# DECKENLEUCHTEN

Ceiling lamps · Plafonniers · Plafonnières · Plafones ·  
Plafoniere · Plafoniere · Kattvalaisimet · Plafony



CARDONA 146



MIKO 350



TOKYO 351



OSAKA 352



NORIAKI 353



WACO 344



PHOENIX 342



TRAY 150



YUMA 340



CESAR 359



RISE 298



DOHA 348



GIRONA 346



ZANDOR 152



BARON 154



FRANKLIN 170



MORGAN 296



CHIROS 368



JULIETA 280



HOSTEL 282

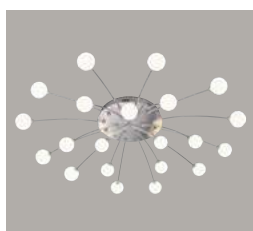

BULLET 336

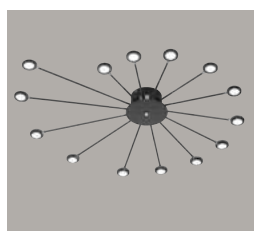

PEACOCK 336



BODRUM 337



MARLEY 476



DISCALGO 240

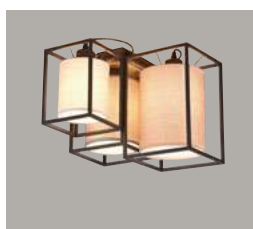

ROSS 264



AGUDO 178



QUINTA 364



RUSTICA 204



TRADITIO 206



ADRIAN 360



SANDRINA 252



LANA 360



ELISA 256



SPIRELLI 254



NAGANO 355



LUNAR 357



SHOGUN 356



SAMURAI 356



CHARLY 354



GONZALO 358



KAGAWA 294



MITA 295

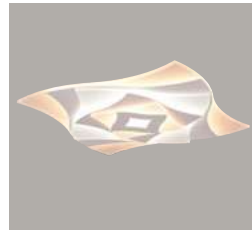

AKITA 294



FOMENTO 232



FERNANDO 322



BISCUIT 321



COOKIE 320



BURTON 268



HOTEL 273



LUGANO 338



HOTEL 272



GARDA 276



CRYSTEL 312



VAPORE 234



DIVA 214



TARIFA 224



CROSS 200



JOHANN 365



TAMIL 199



SIGNA 250

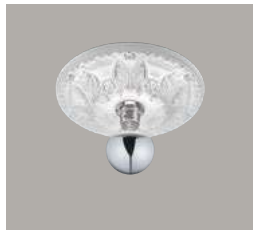

LILLY 362



# WANDLEUCHTEN

Wall lamps · Appliques · Wandlampen · Apliques ·  
Appliques · Lämpje de perete · Seinävalaisimet · Scienne



COAT 371



LACAPO 370



LOUIS 370



CONCHA 374



RAVEN 372



WALES 378



ADRIANO 379



JORDAN 384



ELEMENT 380



MARIO 384



CELESTE 106



PLATON 378



SEQUENCE 112



LUGO 300



PURE 228



CASSIO 430



LYON 428



HOTEL 270



NILAM 75



ARINO 373



EDWARD 413



KAZAN 382



CURTIS 389



CUADRO 388



BALDO 386



BOLDER 386



LINE 386

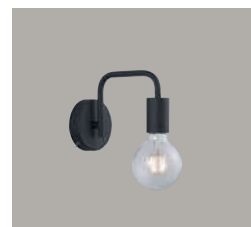

DIALLO 198



TRAVELLER 424



ELISA 256



SANDRINA 252



SPIRELLI 254



SIGNA 250



DIVO 361



ZANDOR 152



MARLEY 474



RAGLAN 376



FAIRFIELD 381



COMFORT 383



MARRIOT 385



CHIROS 368



CLEO 369

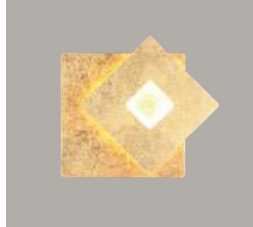

LEANO 367



MIO 366



BRAD 86



RUNA 58



KHAN 74



KARUNI 64



TRADITIO 206



PURA 361



ROMA 362



ZAZOU 362

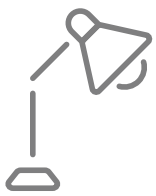

# TISCHLEUCHTEN

Table lamps · Lampes de table · Tafellampen · Sobremesas ·  
Lampa da tavolo · Veioze · Pöytävalaisimet · Lampy stołowe



CELESTE 104



CHARIVARI 110



SEQUENCE 112



BLAZE 114



SYDNEY 132



FRANKLIN 170



RONDO 136



NOLA 440



ALFIE 44



BOCCIA 442



NUBIAN 440

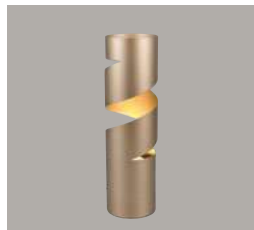

STREAM 180



GILA 196



RUSTICA 204



TRADITIO 206



VAPORE 234



MATARO 216



DIVA 212



FACETTE 210



STEEN 443



FOMENTO 232



PURE 228



JOOST II 445



BERLIN 444



DONNA 444



VENTURA 445



LUIS II 446



EMERALD 446



FYNN II 447



CRISTO 449



ARY II 449



TILL II 448



DAVI II 448





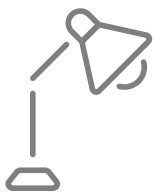

# TISCHLEUCHTEN

Table lamps · Lampes de table · Tafellampen · Sobremesas ·  
Lampa da tavolo · Veioze · Pöytävalaisimet · Lampy stołowe



CASSIO 430



PARIS II 432



LYON 428



NANDOR 433



HOTEL 274



ROSS 264



JULIETA 280



BURTON 268



MATS II 438



GARDA 276



RAHUL 94



KERALA 96



KARUNI 64



TREASURE 63



ELMAU 78



CANIO 43



TARA 42



SMILLA 52



TOBA 50



VINA 62



FIATO 108



TRAVIS 450



MANDURO 451



AMSTERDAM 453



AVA 452



CURTIS 457



NARCOS 416



MARLEY 410



TRAVELLER 424



DIALLO 198



LUPO 455



PRONTO 458



TAJO 459



WANDA 390



FLEXO 459



HOSTEL 282



BALE 439



VELA 436



ELIO 436



TOSH 82



NORRIS 422



MONZA 420



POLO 454



BERGAMO 418



PERRY 456





# STEHLEUCHTEN

Floor lamps · Lampadaires · Vloerlampen · Lámparas de pie ·  
Piantane · Lampadare · Lattiavalaisimet · Lampy podłogowe



NADOR 433



LYON 428



PARIS II 432



CASSIO 430



JULIETA 280



HOTEL 270



BURTON 266



CLAAS 434



HOSTEL 282



TRACY 426



ALFIE 44



HOTEL 274



ROSS 264

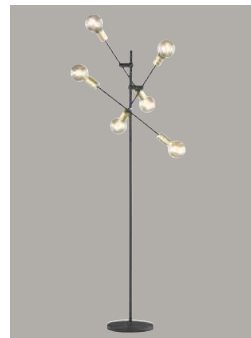

CROSS 200

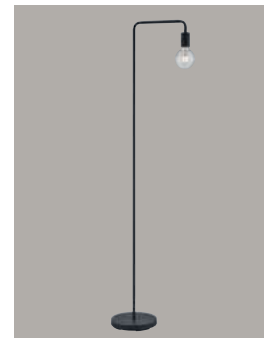

DIALLO 198



RAHUL 94



KERALA 96



BELLARI 99



KARUNI 64



BELL 68



TOBA 50



HEDDA 56



RUNA 58



TOSH 82



HARRIS 66



MANSUR 427



ZIVA 193



KORBA 72



RODRIGO 73





# STEHLEUCHTEN

Floor lamps · Lampadaires · Vloerlampen · Lámparas de pie ·  
Piantane · Lampadare · Lattiavalaisimet · Lampy podłogowe

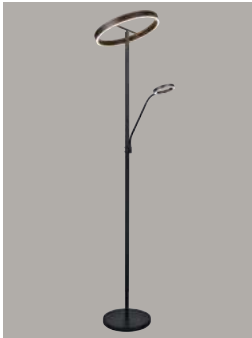

WILLIS 396



FRANKLIN 170

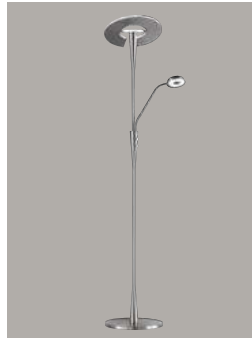

QUEBEC 398

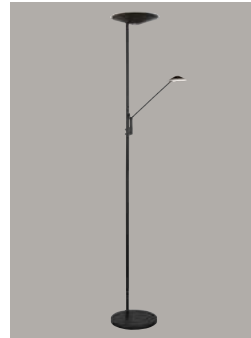

BRANTFORD 400



BARRIE 402

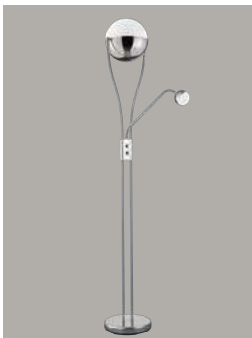

CHRIS 404

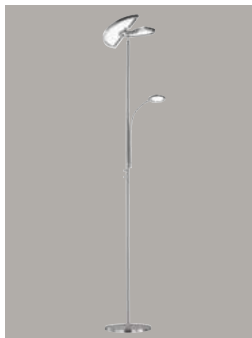

SPLIT 404



SANTO II 405

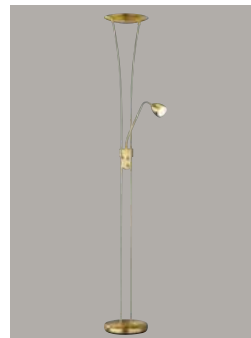

ARIZONA 405



RUSTICA 204



CHARIVARI 110



SEQUENCE 112



BLAZE 114



EDGE 116

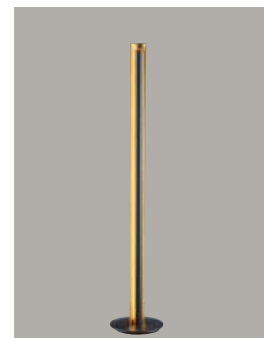

TEXEL 414



FRANKLIN 170



VERONA 419



TRAVELLER 424



SEEKER 415

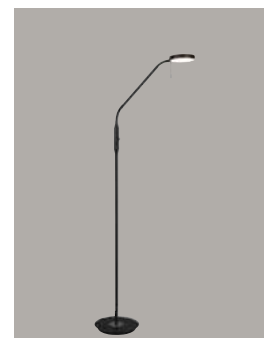

MONZA 420

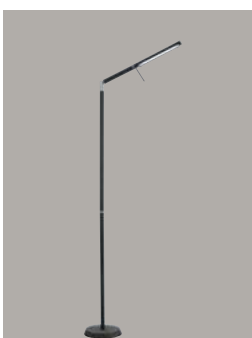

FILIGRAN 417

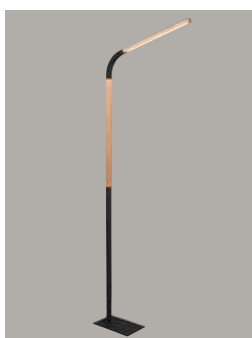

NORRIS 422

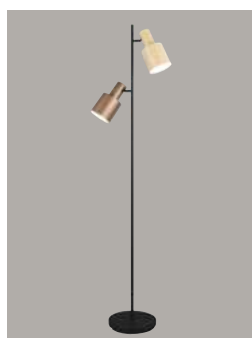

AGUDO 178

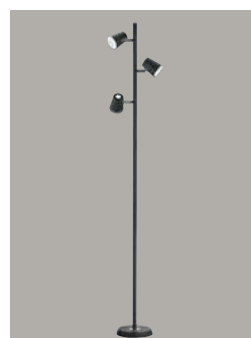

NARCOS 416



DACOTA 412

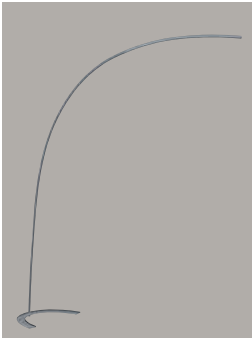

SHANGHAI 406



BANGKOK 407

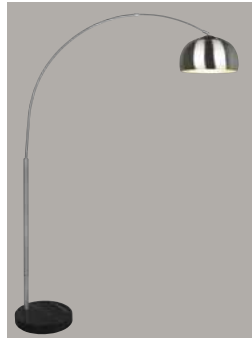

ARGENTINA 408



MARLEY 410



NURIA 134

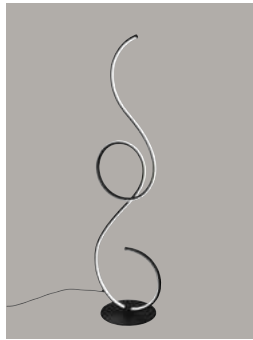

JIVE 138

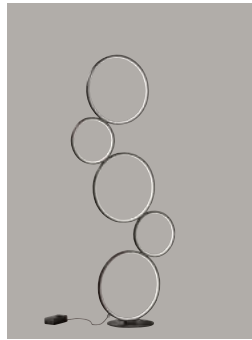

RONDO 136



SYDNEY 132



VAPORE 234



LUMINA 220

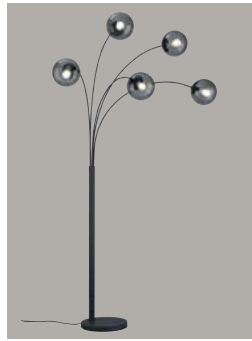

BALINI 226



LANCE 409



BERGAMO 418



PURE 228



FOMENTO 232

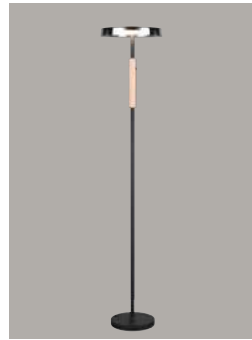

CELESTE 104



EDWARD 413

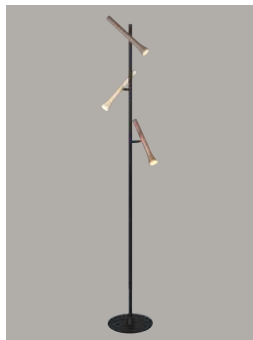

FIATO 108



MARLEY 410



# SPOTSERIEN

Spots · Spotterie · Spots · Focos · Faretti · Spoturi · Spotit · Reflektorki



AMBALA 462



CLAPTON 468



NARCOS 470



TAURUS 464



GUAYANA 466



PAGO 482



SHARP 472



ANGELO 538



MARLEY 474



LEVISTO 488

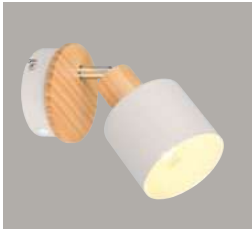

SHANTI 484



ARUNI 483



BELL 68



DELHI 70



TOSH 80



NANDINI 487



AROSA 486



BURTON 268



TARIFA 224



WANDA 390



WANDA 390



LEVISTO 391



LIGARA 391



# 2-PHASEN-SCHIENENSYSTEM



2-phase track system · Système de voie à deux phases · 2-fase-spoorsysteem · Sistema de rieles en 2 fases · Sistema a binario bifase · Sistem de piste cu 2 faze · 2-vaihekiskojärjestelmä · 2-fazowy system prowadnic



RADIATOR 504



LEON 504



MARLEY 507



ANTIBES 506



TOSH 510



TOMMY 510



JIMMY 511



ONTARIO 506



LUMINA 506



ROBIN 506



CAMILLUS 508

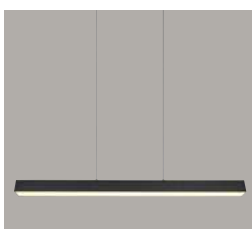

PAROS 509



PANEL 508





# EIN- UND UNTERBAULEUCHTEN

Recessed and cabinet lightings · Eclairages encastrés et éclairages sous armoire ·  
Inbouwverlichtingen en verlichtingen onder de kastjes · Luces empotrables y luces para la parte inferior  
del armario · Lampade da incasso e lampade sottopensili · Lumini încestate și lumini sub dulap ·  
Upotettavat valaisimet ja kaapinalusvalaisimet · Oprawy wpuszczane oraz oprawy podszafkowe



ARGUS 519



NIMBUS 518



AURA 516



CORE 514



ZAGROS 521



ZAGROS 521



PAMIR 520

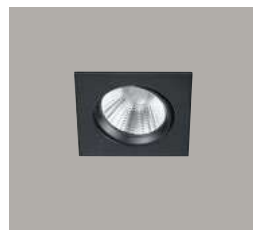

PAMIR 520



RILA 523



DOLOMITE 522



PIRIN 522



DOLOMITE 522



PIRIN 522



JURA 526



JURA 526



KENAI 524

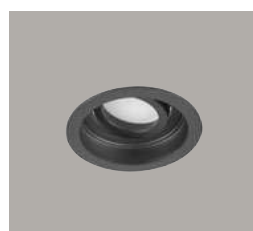

KENAI 524



KENAI 524



ALINO 393



RAMON 392



ECCO 393



# BADEZIMMERLEUCHTEN H<sub>2</sub>O

Bathroom lighting · Éclairage salle de bains · Badkamer verlichting · Iluminación de cuarto de baño ·  
Illuminazione per bagno · Iluminat baie · Kylpyhuone valaistus · Oświetlenie łazienkowe



BOLSA 540



ANGELO 538



ASCARI 555



UMBERTO 556



CONDUS 559



CAMILLA 557



CLARIMO 554



APART 556



PAOLO 560



FRODENO 560



GIANNI 546



THEATRO 544



FABRIZIO 530



ENRICO 534



KULA 543



RAY 542



BOLSA 540



PIERA 536



ARTURO 545



FABIO 532



ROCCO 533



XAVI 558



MATTIMO 548



LINO 550



LORENZO 552



GIADA 553



VIEW 547



<https://www.trio-lighting.com/go-green>



# OUR EARTH OUR HOME

Mit GO GREEN by TRIO setzen wir ein Zeichen für eine grünere Zukunft und zeigen unser Engagement für umweltfreundliche Beleuchtungslösungen. GO GREEN Produkte werden unter Berücksichtigung ökologischer und sozialer Standards hergestellt und bestehen größtenteils aus umweltfreundlichen Komponenten. Dazu gehören recycelte Materialien sowie nachwachsende Rohstoffe aus verantwortungsvollen, nachhaltigen Quellen. Auch bei den Verpackungen unserer GO GREEN Produkte legen wir großen Wert auf Nachhaltigkeit. Durch den Einsatz recycelter Materialien und die Vermeidung von Plastik tragen wir aktiv zum Umweltschutz bei.

With GO GREEN by TRIO, we are setting an example for a greener future and demonstrating our commitment to environmentally friendly lighting solutions. GO GREEN products are manufactured in accordance with ecological and social standards and consist largely of environmentally friendly components. These include recycled materials and renewable raw materials from responsible, sustainable sources. We also attach great importance to sustainability when it comes to the packaging of our GO GREEN products. By using recycled materials and avoiding plastic, we actively contribute to environmental protection.





# CORK NEW

Ein beeindruckendes Beispiel für nachhaltiges Design - Das recycelte farbige Glas bringt lebendige Farben in jeden Raum. Der Kork, ein nachwachsender Rohstoff, ergänzt das Design mit seiner natürlichen Textur und Wärme.

An impressive example of sustainable design - the recycled coloured glass brings vibrant colours to any room. The cork, a renewable resource, complements the design with its natural texture and warmth.



Metall, Glas, Kork · metal, glass, cork



17 | mehrfarbig · multicolor

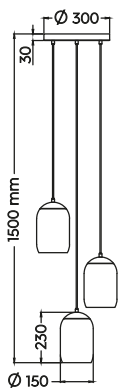

Pendelleuchte · Pendant  
excl. 3 x E27  
max. 10 W  
364630317

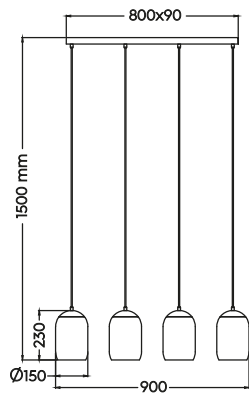

Pendelleuchte · Pendant  
excl. 4 x E27  
max. 10 W  
364600417



✓ Made from sustainable materials







# TARA NEW

Die Tischleuchte TARA passt perfekt in moderne und nachhaltige Einrichtungsstile und setzt stilvolle Akzente. Ihre umweltfreundlichen Materialien und das durchdachte Design machen sie zu einer idealen Wahl für alle, die Wert auf Nachhaltigkeit und Ästhetik legen.

The TARA table lamp fits perfectly into modern and sustainable furnishing styles and sets stylish accents. Its environmentally friendly materials and sophisticated design make it an ideal choice for anyone who values sustainability and aesthetics.

Glas, Kork, Schirm Strohflecht ·  
glass, cork, straw wickerwork

57 | Chrom bedampft · chrome plated

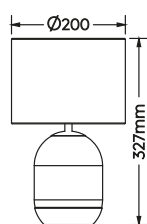

Tischleuchte · Table lamp  
excl. 1 x E27  
max. 10 W  
564900157

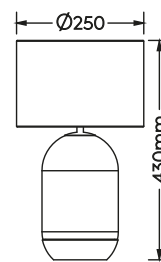

Tischleuchte · Table lamp  
excl. 1 x E27  
max. 10 W  
564990157

✓ Made from sustainable materials



Die Tischleuchte CANIO ist aus Bambus und Pappe gefertigt. Diese Kombination macht die Leuchte zu einem echten Hingucker in jedem Raum. Sie passt perfekt in ein natürliches oder boho-inspiriertes Interieur und bringt ein Stück Natur in Ihr Zuhause.

The CANIO table lamp is made from bamboo and cardboard. This combination makes the lamp a real eye-catcher in any room. It fits perfectly into a natural or boho-inspired interior and brings a piece of nature into your home.



Pappe, Bambus · cardboard, bamboo

11 | Grau · grey

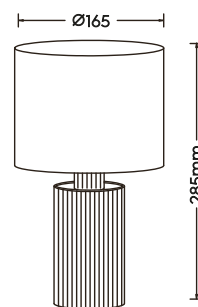

Tischleuchte · Table lamp  
excl. 1 x E14  
max. 40 W  
568100111

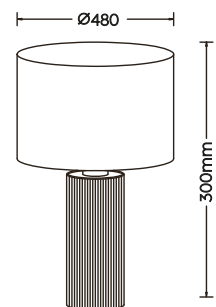

Tischleuchte · Table lamp  
excl. 1 x E27  
max. 40 W  
568190111

✓ Made from sustainable materials



# ALFIE NEW

Die Leuchte ALFIE ist ein stilvolles und umweltfreundliches Beleuchtungselement, das aus recyceltem Metall gefertigt ist. Sie ist in den Farben Schwarz matt und Warm grey erhältlich, was sie zu einer vielseitigen Ergänzung für verschiedene Einrichtungsstile macht.

The ALFIE luminaire is a stylish and environmentally friendly lighting element made from recycled metal. It is available in matt black and warm grey, making it a versatile addition to various interior styles.



Metall · metal

 **32** | Schwarz matt · black mat

 **76** | Warm Grau · warm grey

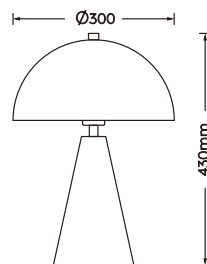

Tischleuchte · Table lamp  
excl. 1 x E27  
max. 40 W  
**565000132**  
**565000176**

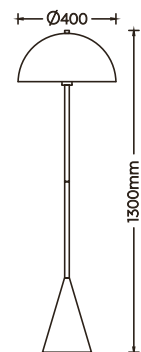

Stehleuchte · Floor lamp  
excl. 1 x E27  
max. 40 W  
**465000132**  
**465000176**

 Made from sustainable materials









# NATURE

Leuchten aus natürlichen Materialien gibt es in vielen verschiedenen Designs, von rustikal und traditionell bis hin zu modern und minimalistisch. Sie verbinden Funktionalität mit natürlicher Schönheit und bringen eine warme und einladende Atmosphäre in jeden Raum.

Lights made from natural materials are available in many different designs, from rustic and traditional to modern and minimalist. They combine functionality with natural beauty and bring a warm and inviting atmosphere to any room.







# TOBA NEW

Mit ihrer Kombination aus Jute und Holz sind die Leuchten nicht nur nachhaltig, sondern auch dekorative Highlights, die jedem Raum eine besondere Note verleihen. Sie sind die ideale Wahl für alle, die Wert auf Natürlichkeit und eine gemütliche Lichtstimmung legen.

With their combination of jute and wood, the lights are not only sustainable, but also decorative highlights that add a special touch to any room. They are the ideal choice for anyone who values naturalness and a cosy lighting atmosphere.



Stehleuchte · Floor lamp  
excl. 1 x E27  
max. 10 W  
467200130

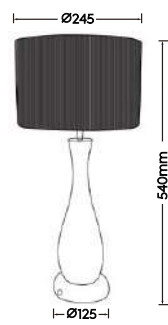

Tischleuchte · Table lamp  
excl. 1 x E27  
max. 10 W  
567200130



 30 | holzfarbig · wood coloured



# JANNE NEW

Die Pendelleuchte JANNE bringt mit ihrem natürlichen Charme und der Verwendung von Jute als Hauptmaterial eine warme und einladende Atmosphäre in jeden Raum.

With its natural charm and the use of jute as the main material, the JANNE pendant light brings a warm and inviting atmosphere to any room.

Jute, Metall · jute, metal

**36** | naturbelassen · natural finish

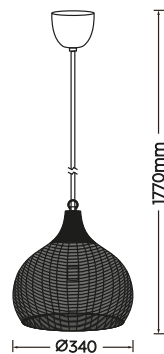

Pendelleuchte · Pendant  
excl. 1 x E27  
max. 10 W  
**366790136**

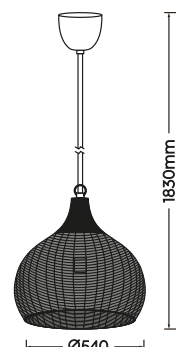

Pendelleuchte · Pendant  
excl. 1 x E27  
max. 10 W  
**366700136**



# SMILLA NEW

Die Leuchterserie aus Jute bringt Nachhaltigkeit und Gemütlichkeit in Ihr Zuhause. Das natürliche Material Jute verleiht den Leuchten eine rustikale und zugleich elegante Optik, die perfekt zu verschiedenen Einrichtungsstilen passt.

The jute light series brings sustainability and cosiness into your home. The natural jute material gives the lights a rustic yet elegant look that perfectly complements various interior styles.

Jute, Metall Schwarz matt ·  
jute, metal black mat

 **36** | naturbelassen · natural finish

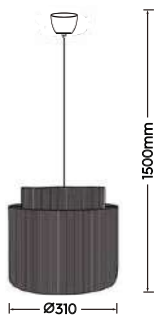

Pendelleuchte · Pendant  
excl. 1 x E27  
max. 10 W  
**366800136**

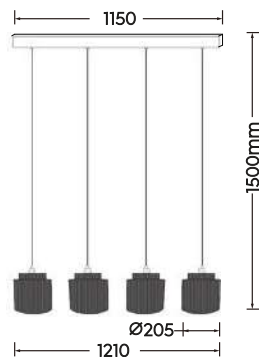

Pendelleuchte · Pendant  
excl. 4 x E27  
max. 10 W  
**366800436**

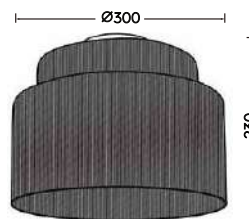

Deckenleuchte · Ceiling lamp  
excl. 4 x E27  
max. 10 W  
**666800136**



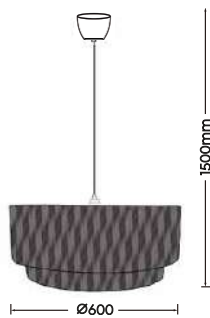

Pendelleuchte · Pendant  
 excl. 1 x E27  
 max. 10 W  
**366890136**

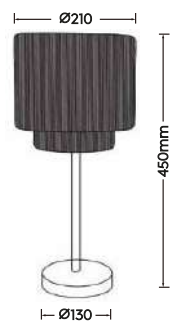

Tischleuchte · Table lamp  
 excl. 1 x E27  
 max. 10 W  
**566800136**



SVEA **NEW**



Mit ihrer Kombination aus natürlichem Baumwollschirm und einzigartigem Design sind diese Leuchten nicht nur dekorativ, sondern auch ästhetisch ansprechend. Sie sind die perfekte Wahl für alle, die Wert auf eine angenehme Lichtstimmung und ein interessantes Design legen.

With their combination of natural cotton shade and unique design, these lights are not only decorative but also aesthetically pleasing. They are the perfect choice for anyone who values a pleasant lighting atmosphere and an interesting design.

Baumwolle, Metall ·  
Cotton, metal



44 | Beige · fawn

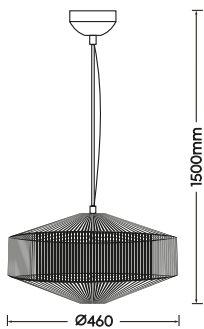

Pendelleuchte · Pendant  
excl. 1 x E27  
max. 10 W  
**364700144**

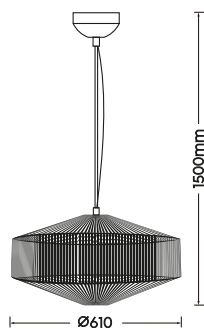

Pendelleuchte · Pendant  
excl. 1 x E27  
max. 10 W  
**364790144**

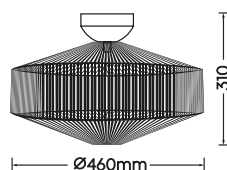

Deckenleuchte · Ceiling lamp  
excl. 1 x E27  
max. 10 W  
**664700144**





# HEDDA

Die Kombination aus Sisal und den klaren, modernen Formen der Leuchten schafft eine zeitlose Eleganz. Die natürliche Farbgebung des Sisals harmonisiert wunderbar mit verschiedenen Einrichtungsstilen.

The combination of sisal and the clear, modern shapes of the lights creates a timeless elegance. The natural colouring of the sisal harmonises wonderfully with different furnishing styles.

Metall Schwarz matt, Sisal ·  
metal black mat, sisal



36 | naturbelassen · natural finish

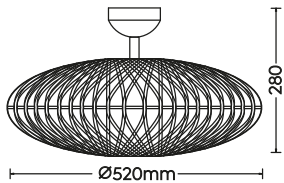

Deckenleuchte · Ceiling lamp  
excl. 2 x E27  
max. 40 W  
612300236

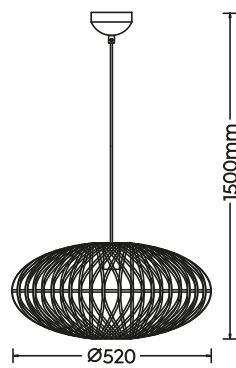

Pendelleuchte · Pendant  
excl. 1 x E27  
max. 40 W  
312300136

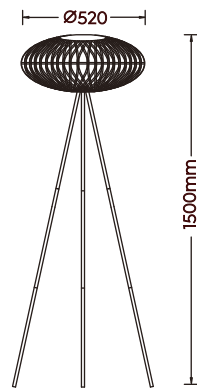

Stehleuchte · Floor lamp  
excl. 1 x E27  
max. 40 W  
412300136







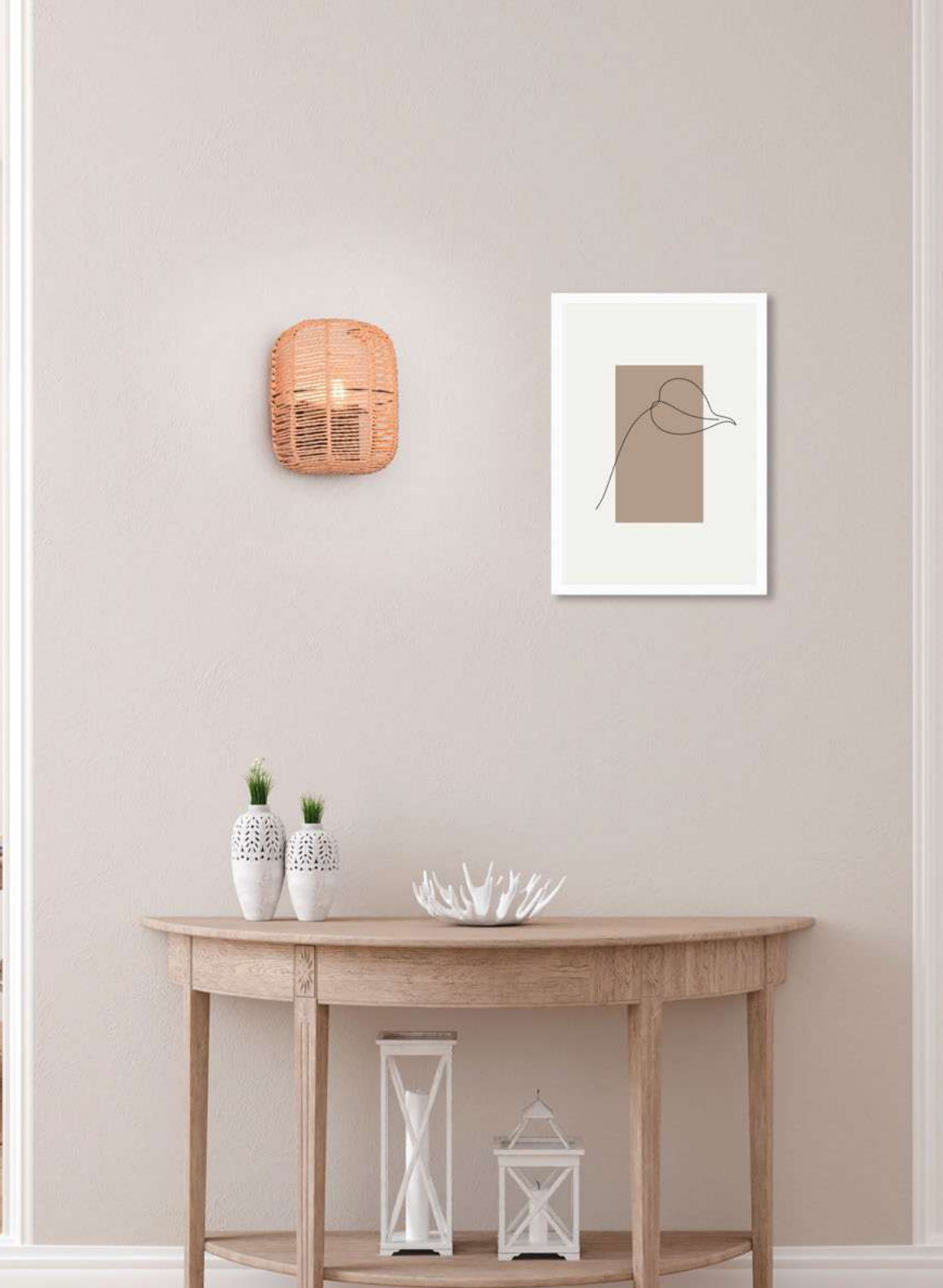

Metall, Sisal · metal, sisal



32 | Schwarz matt · black mat

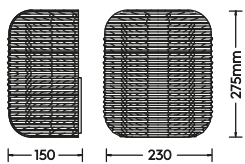

Wandleuchte · Wall lamp  
excl. 1 x E27  
max. 60 W  
203000132

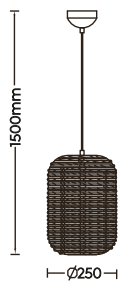

Pendelleuchte · Pendant  
excl. 1 x E27  
max. 40 W  
303000132

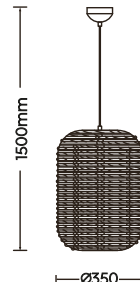

Pendelleuchte · Pendant  
excl. 1 x E27  
max. 40 W  
303090132



Stehleuchte · Floor lamp  
excl. 1 x E27  
max. 40 W  
403000132



# RUNA

Das natürliche Material Sisal verleiht den Leuchten eine rustikale und zugleich elegante Optik, die perfekt zu verschiedenen Einrichtungsstilen passt.

The natural material sisal gives the lights a rustic yet elegant look that perfectly complements a variety of furnishing styles.



# INGA

Rattengeflecht verleihen Ihrem Zuhause einen natürlichen Flair und erinnern an ein Ferienhaus am Meer.

Rat wicker lends your home a natural flair and is reminiscent of a holiday home by the sea.

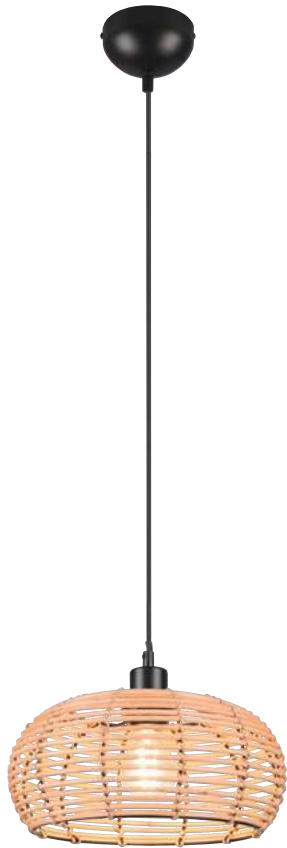

Metall Schwarz matt, Rattengeflecht · metal black mat, rattan meshwork



36 | naturbelassen · natural finish

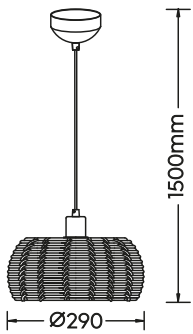

Pendelleuchte · Pendant

excl. 1 x E27  
max. 40 W

312200136

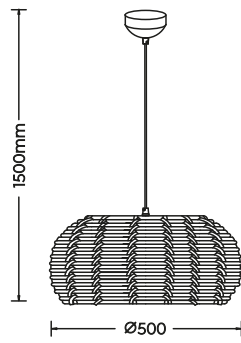

Pendelleuchte · Pendant

excl. 3 x E27  
max. 40 W

312200336



# PLANT

Naturbelassenes Holz mit herabhängenden Pflanzen schafft eine harmonische Verbindung zwischen Natur und modernem Design.

Natural wood with hanging plants creates a harmonious combination of nature and modern design.



Art.-Nr. 92945

Deko-Pflanze nicht enthalten! ·  
Decoration not included!

Metall, Sisal · metal, Sisal

67 | Nickel antik · nickel antique

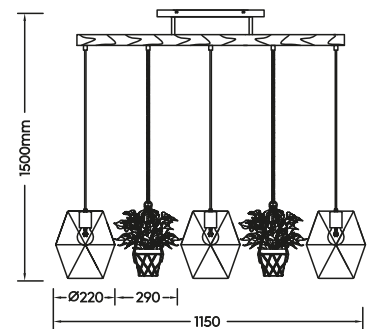

Pendelleuchte · Pendant

excl. 3 x E27

max. 40 W

301000367



# VINA **NEW**

Der Lampenschirm aus Seegras bringt die Schönheit der Natur ins Haus und sorgt für eine warme, diffuse Lichtverteilung.

The seagrass lampshade brings the beauty of nature into the home and provides a warm, diffuse light distribution.



Keramik, Seegras · ceramic, seaweed

01 | Weiß · white

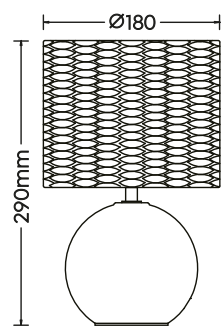

Tischleuchte · Table lamp  
excl. 1 x E27  
max. 40 W

518900101

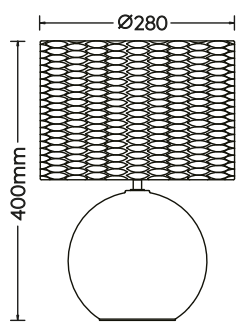

Tischleuchte · Table lamp  
excl. 1 x E27  
max. 40 W

518990101



Die Leuchte erinnert an eine kleine Schatzkiste und verleiht jedem Raum einen Hauch von Magie. Der eingebaute Kontaktschalter sorgt dafür, dass das Licht automatisch eingeschaltet wird, sobald der Deckel geöffnet wird. Diese einzigartige Funktion kombiniert mit dem charmanten Design macht die Leuchte zu einem besonderen Highlight.

The light is reminiscent of a small treasure chest and adds a touch of magic to any room. The built-in contact switch ensures that the light switches on automatically as soon as the lid is opened. This unique function combined with the charming design makes the light a special highlight.

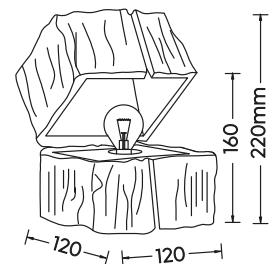

Tischleuchte · Table lamp

incl. LED E14  
2 W / 225 Lumen  
2.700 Kelvin

514110101

514110102

514110130

- 01 | Weiß · white
- 02 | Schwarz · black
- 30 | holzfarbig · wood coloured



# KARUNI NEW

Die Leuchtenserie KARUNI vereint die Schönheit naturbelassenen Holzes mit der modernen Raffinesse von Kunstharz. Diese einzigartige Kombination schafft eine harmonische Verbindung von Natur und Design, die jedem Raum eine besondere Atmosphäre verleiht.

The KARUNI luminaire series combines the beauty of natural wood with the modern sophistication of synthetic resin. This unique combination creates a harmonious fusion of nature and design that lends any room a special atmosphere.



Metall Schwarz matt, Holz · metal black mat, wood

30 | holzfarbig · wood coloured



Stehleuchte · Floor lamp  
excl. 3 x E27  
max. 10 W  
**463300330**

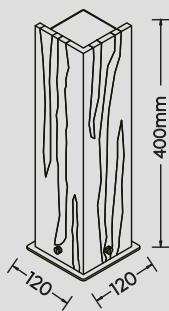

Tischleuchte · Table lamp  
excl. 1 x E27  
max. 10 W  
**563300130**



Wandleuchte · Wall lamp  
excl. 1 x E14  
max. 10 W  
**263300130**







# HARRIS

Die Kombination aus Metall und Naturholz schafft eine zeitlose Verbindung zwischen moderner Klarheit und echtem HYGGE-Style. Das helle Holz ergänzt sich perfekt mit den schwarz-goldenen Schirmen und schafft warme Atmosphäre.

The combination of metal and natural wood creates a timeless connection between modern clarity and genuine HYGGE style. The light-coloured wood complements the black and gold shades perfectly and creates a warm atmosphere.

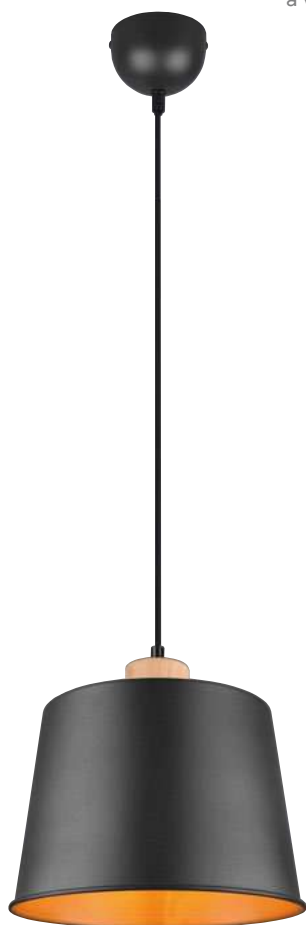

Metall, innen goldfarbig, Holz ·  
metal, gold colored inside, wood



32 | Schwarz matt · black mat

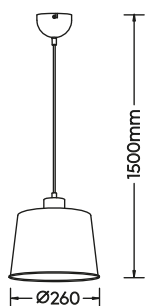

Pendelleuchte · Pendant  
excl. 1 x E27  
max. 60 W  
312700132

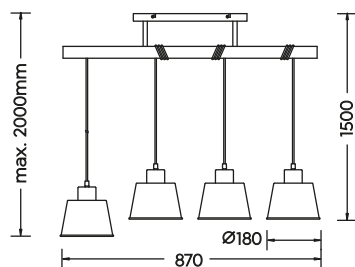

Pendelleuchte · Pendant  
excl. 4 x E27  
max. 40 W  
312700432

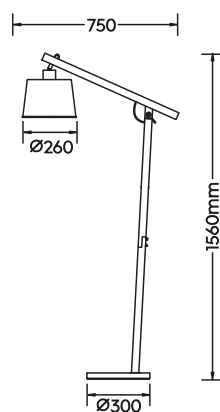

Stehleuchte · Floor lamp  
excl. 1 x E27  
max. 60 W  
412700132







Strahler · Spot  
excl. 2 x E14  
max. 25 W  
801900267

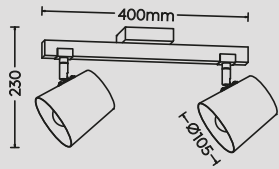

Strahler · Spot  
excl. 3 x E14  
max. 25 W  
801900367

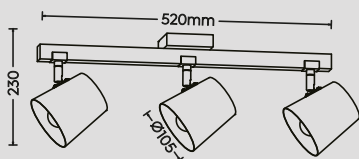

Metall, Holz · metal, wood

67 | Nickel antik · nickel antique

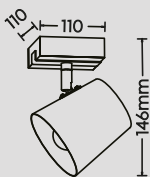

Strahler · Spot  
excl. 1 x E14  
max. 25 W  
801900167

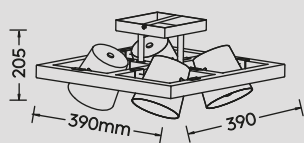

Deckenleuchte · Ceiling lamp  
excl. 4 x E14  
max. 25 W  
601900467



Stehleuchte · Floor lamp  
excl. 3 x E14  
max. 25 W  
401900367

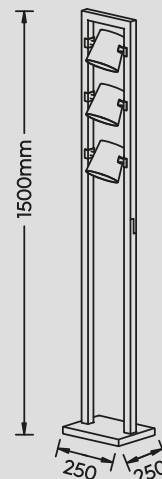

# BELL

Die Metallkomponenten verleihen den Leuchten eine moderne und elegante Note, während die Holzelemente für Wärme und Natürlichkeit sorgen.

The metal components give the lights a modern and elegant touch, while the wooden elements provide warmth and naturalness.

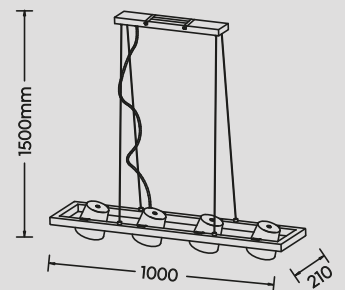
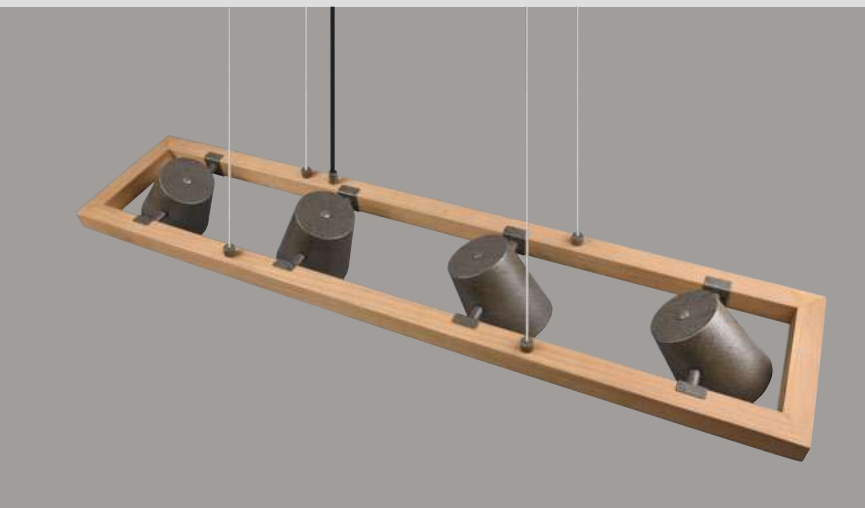

Pendelleuchte · Pendant

excl. 4 x E14

max. 25 W

301900467



IP20

# DELHI

Die Kombination aus Holz und Metall verleiht jedem Zuhause einen gemütlichen Vintage-Look.

The combination of wood and metal gives every home a cosy vintage look.



Metall, Holz · metal, wood

67 | Nickel antik · nickel antique

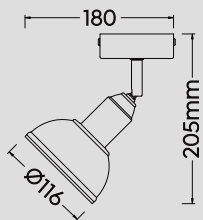

Strahler · Spot  
excl. 1 x E14  
max. 40 W  
803400167

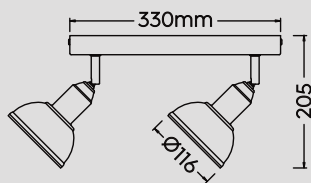

Strahler · Spot  
excl. 2 x E14  
max. 40 W  
803400267

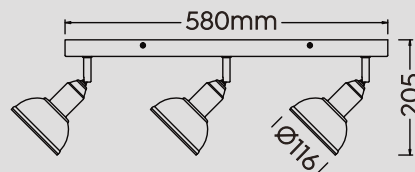

Strahler · Spot  
excl. 3 x E14  
max. 40 W  
803400367



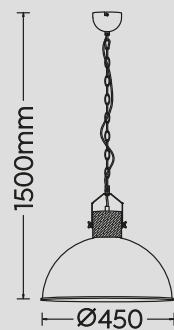

Pendelleuchte · Pendant  
 excl. 1 x E27  
 max. 60 W  
 303400167

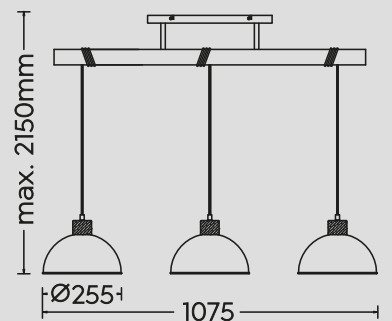

Pendelleuchte · Pendant  
 excl. 3 x E27  
 max. 42 W  
 303400367



# KORBA

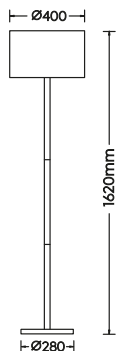

Stehleuchte · Floor lamp

excl. 1 x E27  
max. 60 W

401200101



Holz, Stoffschirm · wood, fabric shade

01 | Weiß · white



# RODRIGO

Metall, innen goldfarbig, Holz ·  
metal, gold colored inside, wood

67 | Nickel antik · nickel antique

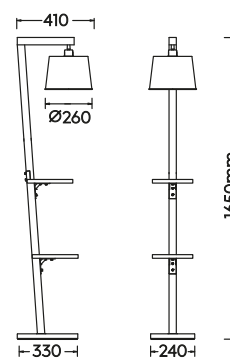

Stehleuchte · Floor lamp

excl. 1 x E27

max. 60 W

402690167



# KHAN

Metall, Holz · metal, wood

67 | Nickel antik · nickel antique

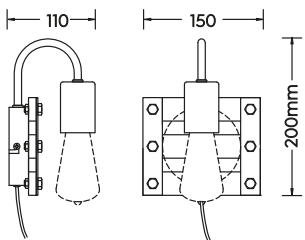
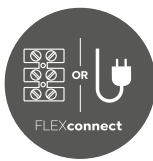

Wandleuchte · Wall lamp  
excl. 1 x E27  
max. 28 W  
**205570167**

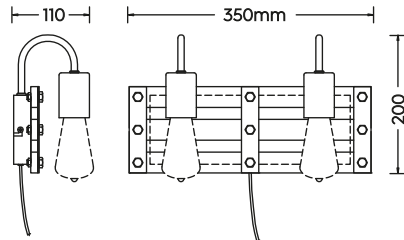

Wandleuchte · Wall lamp  
excl. 2 x E27  
max. 28 W  
**205570267**



Empfohlen:  
recommended:

Filament LED E27  
6 W / 600 Lumen  
2.700 Kelvin  
**987-679**



Empfohlen:  
recommended:

Filament LED E27  
7 W / 806 Lumen  
2.700 Kelvin  
**987-600**

# NILAM



Getrennt schaltbar ·  
Separately switchable



Flexibel ·  
Flexible



Holz, Stoffschirm · wood, fabric shade

36 | naturbelassen · natural finish

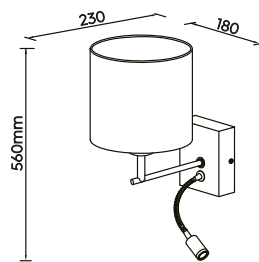

Wandleuchte · Wall lamp

excl. 1 x E27  
max. 28 W  
incl. OSRAM-LED  
3,1 W / 310 Lumen  
3.000 Kelvin

212879236



IP20

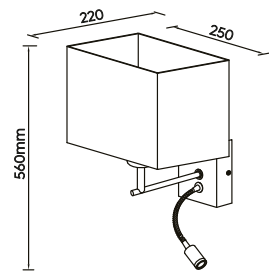

Wandleuchte · Wall lamp

excl. 1 x E27  
max. 28 W  
incl. OSRAM-LED  
3,1 W / 310 Lumen  
3.000 Kelvin

212870236



IP20

# ISEO **NEW**



## SWITCH DIMMER

Helligkeit in 3 Stufen mit herkömmlichem Lichtschalter einstellbar.

Brightness adjustable in 4 levels with conventional light switch.



Holz · wood

 **02** | Schwarz · black

 **30** | holzfarbig · wood coloured

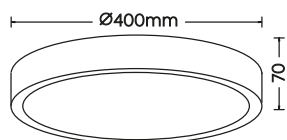

Deckenleuchte · Ceiling lamp

incl. SMD-LED

24 W / 2.500 Lumen

3.000 Kelvin

**647410102**

**647410130**



 IP20



# SEASONS



Holz naturbelassen, Stoff ·  
wood natural finish, fabric



01 | Weiß · white



02 | Schwarz · black

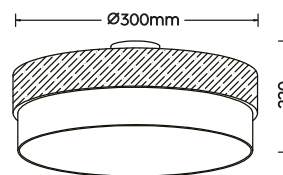

Deckenleuchte · Ceiling lamp  
excl. 2 x E14  
max. 40 W  
611500201  
611500202

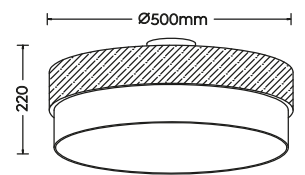

Deckenleuchte · Ceiling lamp  
excl. 3 x E27  
max. 40 W  
611500301  
611500302



# ELMAU

Naturmaterialien wie Holz und Stoff verleihen den Leuchten der Serie ELMAU eine einladende und behagliche Ausstrahlung. Diese Materialien schaffen eine Atmosphäre, in der man sich sofort wohlfühlt.

Natural materials such as wood and fabric give the lights in the ELMAU range an inviting and cosy appearance. These materials create an atmosphere in which you immediately feel at ease.

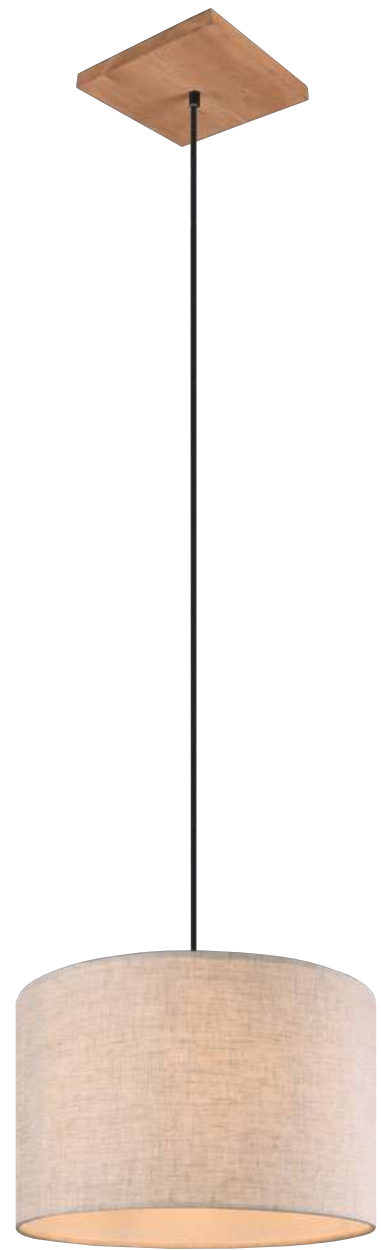

Holz, Stoffschirm beige · wood, fabric shade fawn

30 | holzfarbig · wood coloured

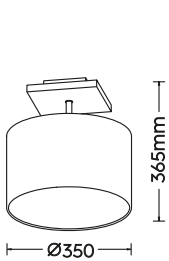

Deckenleuchte · Ceiling lamp  
excl. 1 x E27  
max. 60 W  
602100130

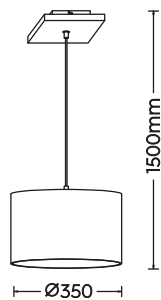

Pendelleuchte · Pendant  
excl. 1 x E27  
max. 60 W  
302100130

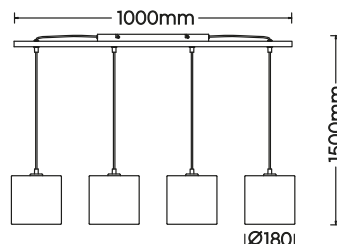

Pendelleuchte · Pendant  
excl. 4 x E27  
max. 60 W  
302100430

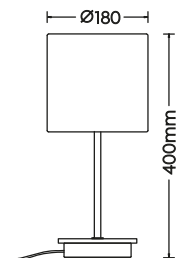

Tischleuchte · Table lamp  
excl. 1 x E14  
max. 40 W  
502100130





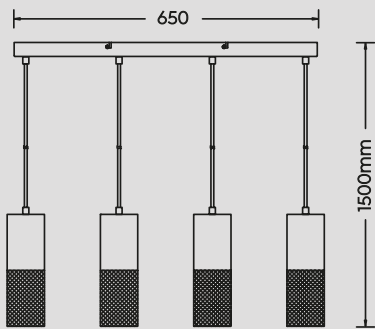

Pendelleuchte · Pendant

excl. 4 x E27  
max. 40 W

304300432

304300434 **NEW**

Metall, Holz · metal, wood



32 | Schwarz matt · black mat



34 | Schwarz-Weiß · black and white





# TOSH



Die TOSH-Leuchten zeichnen sich durch ihr zeitloses Design aus, das sowohl in modernen als auch in klassischen Interieurs hervorragend zur Geltung kommt. Das filigrane Metallgitter sorgt für eine interessante Lichtverteilung, während das Holz eine warme und einladende Atmosphäre schafft.

The TOSH lights are characterised by their timeless design, which looks great in both modern and classic interiors. The filigree metal grid ensures interesting light distribution, while the wood creates a warm and inviting atmosphere.

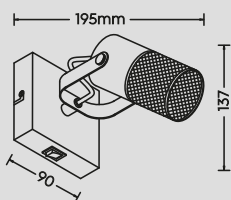

Strahler · Spot  
excl. 1 x E14  
max. 15 W  
804370132  
804370134 **NEW**

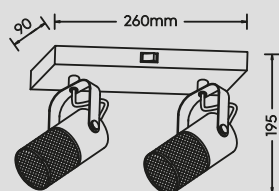

Strahler · Spot  
excl. 2 x E14  
max. 15 W  
804370232  
804370234 **NEW**

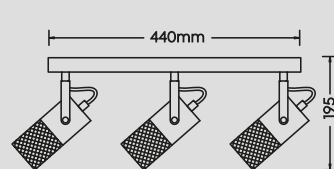

Strahler · Spot  
excl. 3 x E14  
max. 40 W  
804300332  
804300334 **NEW**

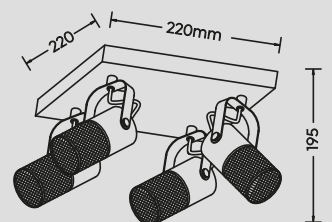

Strahler · Spot  
excl. 4 x E14  
max. 40 W  
804300432  
804300434 **NEW**



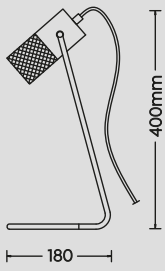

Tischleuchte · Table lamp  
 excl. 1 x E14  
 max. 15 W  
 504300132

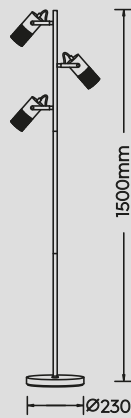

Stehleuchte · Floor lamp  
 excl. 3 x E14  
 max. 15 W  
 404300332



# TOSH

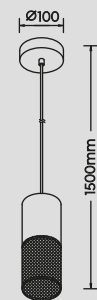

Pendelleuchte · Pendant  
 excl. 1 x E27  
 max. 40 W  
 304300132  
 304300134 **NEW**

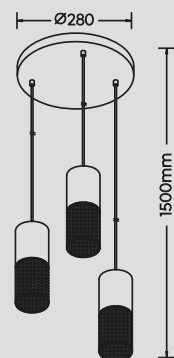

Pendelleuchte · Pendant  
 excl. 3 x E27  
 max. 40 W  
 304330332  
 304330334 **NEW**



Metall, Holz · metal, wood

 **32** | Schwarz matt · black mat

 **34** | Schwarz-Weiß · black and white

# COLINO

Metall, Holz · metal, wood

32 | Schwarz matt · black mat

42 | Anthrazit · anthracite

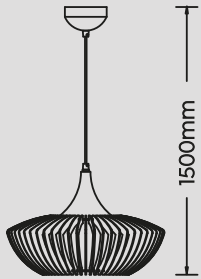

Ø400

Pendelleuchte · Pendant

excl. 1 x E27

max. 40 W

315900132

315900142



# BOOLAN

Holz · wood

26 | Braun · brown

30 | holzfarbig · wood coloured



Ø500

Pendelleuchte · Pendant

excl. 1 x E27

max. 60 W

305900126

305900130



# AGRA



Metall, Holz · metal, wood



32 | Schwarz matt · black mat

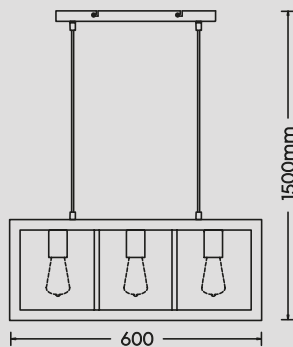

Pendelleuchte · Pendant  
excl. 3 x E27  
max. 10 W  
**313800332**

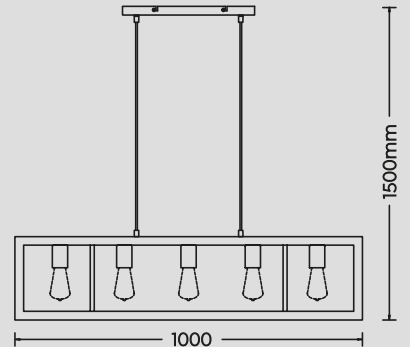

Pendelleuchte · Pendant  
excl. 5 x E27  
max. 10 W  
**313800532**



# BRAD

Modern kann auch gemütlich sein! Das Beste Beispiel dafür ist die Serie BRAD aus Naturholz kombiniert mit moderner LED Technik.

Modern can also be cosy! The best example of this is the BRAD range made of natural wood combined with modern LED technology.



## SWITCH DIMMER

Helligkeit in 3 Stufen mit herkömmlichem Lichtschalter einstellbar.

Brightness adjustable in 4 levels with conventional light switch.



## Memory Funktion

Die zuletzt gewählte Licht-Einstellung wird gespeichert und beim erneuten Einschalten der Leuchte verwendet.

## Memory function

The last selected light setting is stored and used for switching the lamp on again.



Metall Nickel antik, Holz · metal nickel antique, wood



30 | holzfarbig · wood coloured

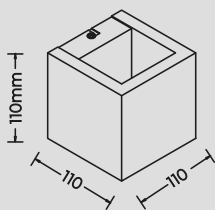

Wandleuchte · Wall lamp

incl. SMD-LED  
4,3 W / 430 Lumen  
3.000 Kelvin

223710130

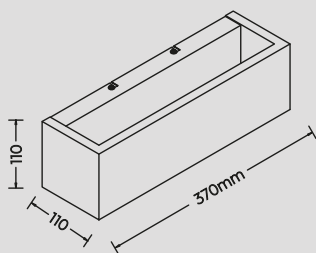

Wandleuchte · Wall lamp

incl. SMD-LED  
13,5 W / 1.500 Lumen  
3.000 Kelvin

223790130

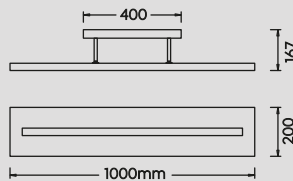

Deckenleuchte · Ceiling lamp

incl. SMD-LED  
27 W / 3.400 Lumen  
3.000 Kelvin

623710130

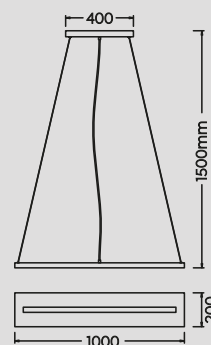

Pendelleuchte · Pendant

incl. SMD-LED  
27 W / 3.400 Lumen  
3.000 Kelvin

323710130





# HARPER

Eine harmonische Mischung aus Gemütlichkeit und Eleganz. Die Kombination aus Holz und Metall betont den eleganten Wohnstil und verleiht jedem Raum eine stilvolle Atmosphäre.

A harmonious blend of cosiness and elegance. The combination of wood and metal emphasises the elegant living style and gives every room a stylish atmosphere.



## SWITCH DIMMER

Helligkeit in 3 Stufen mit herkömmlichem Lichtschalter einstellbar.

Brightness adjustable in 4 levels with conventional light switch.



Metall, Holz naturbelassen · metal, wood natural finish

32 | Schwarz matt · black mat

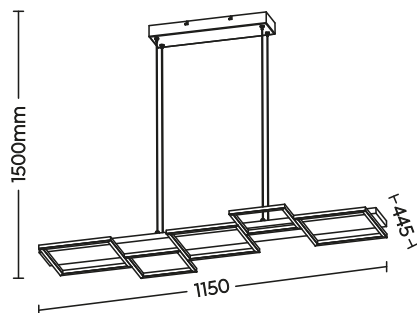

Pendelleuchte · Pendant

incl. SMD-LED  
42 W / 5.700 Lumen  
3.000 Kelvin

322910532

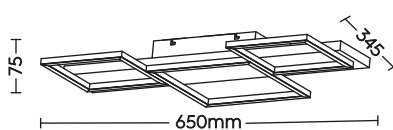

Deckenleuchte · Ceiling lamp

incl. SMD-LED  
30 W / 4.000 Lumen  
3.000 Kelvin

622910332

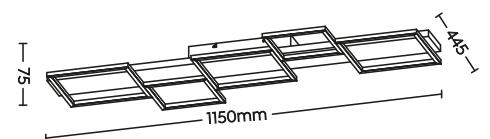

Deckenleuchte · Ceiling lamp

incl. SMD-LED  
42 W / 5.700 Lumen  
3.000 Kelvin

622910532







# FONTANA NEW

Die LED-Deckenpaneele kombinieren modernes Design mit der natürlichen Schönheit. Das naturbelassene Holz verleiht jedem Raum eine warme und einladende Atmosphäre, während die integrierte LED-Technologie für eine gleichmäßige und energieeffiziente Beleuchtung sorgt.

The LED ceiling panels combine modern design with natural beauty. The natural wood gives every room a warm and inviting atmosphere, while the integrated LED technology ensures even and energy-efficient lighting.



## SWITCH DIMMER

Helligkeit in 3 Stufen mit herkömmlichem Lichtschalter einstellbar.

Brightness adjustable in 4 levels with conventional light switch.

Metall, Holz naturbelassen · metal, wood natural finish

32 | Schwarz matt · black mat

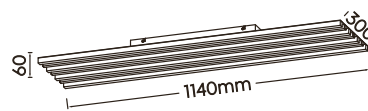
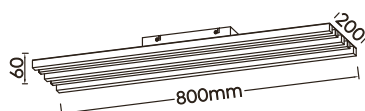
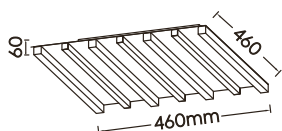

Deckenleuchte · Ceiling lamp

incl. SMD-LED  
22 W / 2.450 Lumen  
3.000 Kelvin

648914532



Deckenleuchte · Ceiling lamp

incl. SMD-LED  
27 W / 3.050 Lumen  
3.000 Kelvin

648917532



Deckenleuchte · Ceiling lamp

incl. SMD-LED  
44 W / 5.050 Lumen  
3.000 Kelvin

648911332





# RAMA



## SWITCH DIMMER

Helligkeit in 3 Stufen mit herkömmlichem Lichtschalter einstellbar.

Brightness adjustable in 4 levels with conventional light switch.

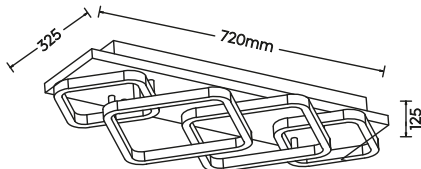
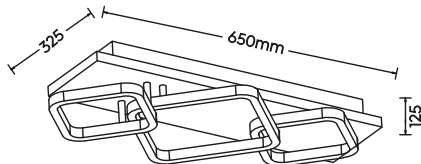

Deckenleuchte · Ceiling lamp

incl. SMD-LED

32 W / 3.800 Lumen

3.000 Kelvin

643210332



Deckenleuchte · Ceiling lamp

incl. SMD-LED

36 W / 4.200 Lumen

3.000 Kelvin

643210432



Metall, Holz naturbelassen ·  
metal, wood natural finish



32 | Schwarz matt · black mat





### SWITCH DIMMER

Helligkeit in 3 Stufen mit herkömmlichem Lichtschalter einstellbar.

Brightness adjustable in 4 levels with conventional light switch.

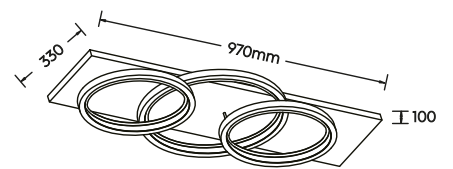
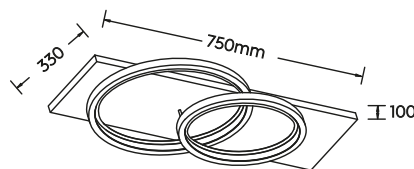
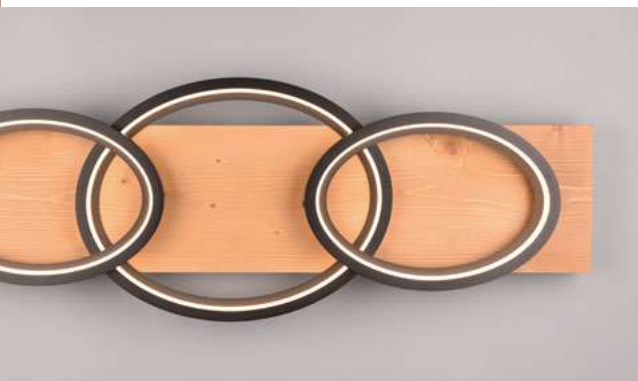

Metall, Holz naturbelassen · metal, wood natural finish



**31** | Weiß matt · white mat



**32** | Schwarz matt · black mat

Deckenleuchte · Ceiling lamp

incl. SMD-LED  
30 W / 3.500 Lumen  
3.000 Kelvin

**641110231**  
**641110232**



 IP20

Deckenleuchte · Ceiling lamp

incl. SMD-LED  
40 W / 4.700 Lumen  
3.000 Kelvin

**641110331**  
**641110332**



 IP20

# RAHUL NEW

Der hochwertige Stoffschirm sorgt für eine sanfte Lichtverteilung, während die LEDs entlang des Holzfußes zusätzliche Akzente setzen und das Ambiente weiter aufwertet.

The high-quality fabric shade ensures a soft light distribution, while the LEDs along the wooden base provide additional accents and further enhance the ambience.



Sensordimmer ·  
Sensor dimmer



On/Off Touch Funktion ·  
On/Off Touch function



Getrennt schaltbar ·  
Separately switchable

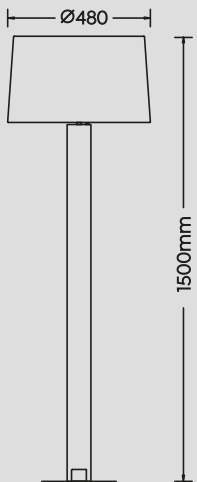

Stehleuchte · Floor lamp

excl. 1 x E27  
max. 40 W  
incl. SMD-LED  
10 W / 1.200 Lumen  
3.000 Kelvin  
**447610232**

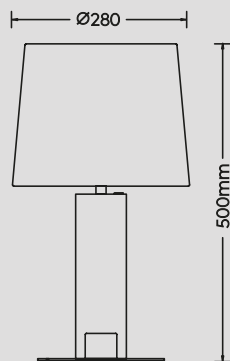

Tischleuchte · Table lamp

excl. 1 x E27  
max. 40 W  
incl. SMD-LED  
6 W / 700 Lumen  
3.000 Kelvin  
**547610232**

Metall, Holz · metal, wood



**32** | Schwarz matt · black mat





# KERALA

Durch die Verwendung von naturbelassenem Holz strahlen diese Leuchten nicht nur Eleganz aus, sondern sind auch langlebig und nachhaltig. Das geradlinige Design sorgt für eine schlichte, aber dennoch beeindruckende Ästhetik.

Thanks to the use of natural wood, these lights not only radiate elegance, but are also durable and sustainable. The straightforward design creates a simple yet impressive aesthetic.



#### 4 fach TOUCH

Diese Leuchte ist durch Berührung in 4 Helligkeitsstufen schaltbar.

#### 4 level Touch function

This light fitting has a touch switch for 4 light intensity levels.

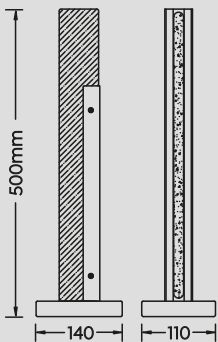
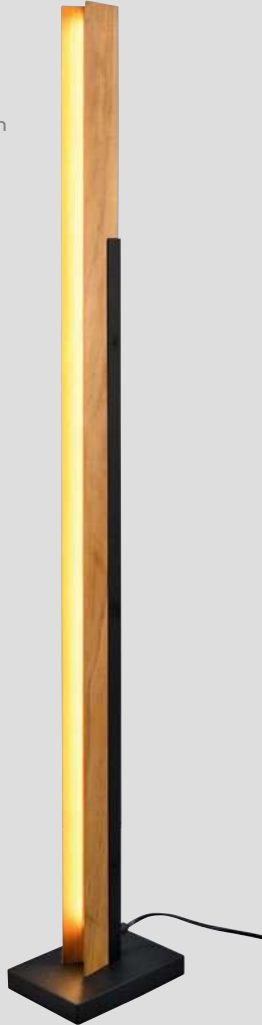

Tischleuchte · Table lamp  
incl. SMD-LED  
8 W / 950 Lumen  
3.000 Kelvin  
541610132

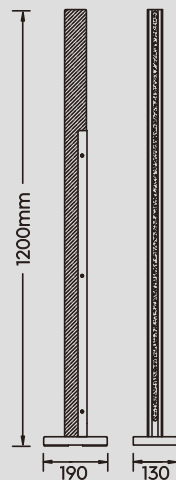

Stehleuchte · Floor lamp  
incl. SMD-LED  
16 W / 1.950 Lumen  
3.000 Kelvin  
441610132

Metall, Holz naturbelassen ·  
metal, wood natural finish



32 | Schwarz matt · black mat



IP20



IP20





#### 4 fach TOUCH

Diese Leuchte ist durch Berührung in 4 Helligkeitsstufen schaltbar.

#### 4 level Touch function

This light fitting has a touch switch for 4 light intensity levels.

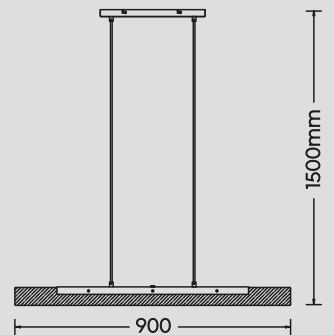

Pendelleuchte · Pendant

incl. SMD-LED  
25 W / 3.000 Lumen  
3.000 Kelvin  
**341610132**



# DEACON

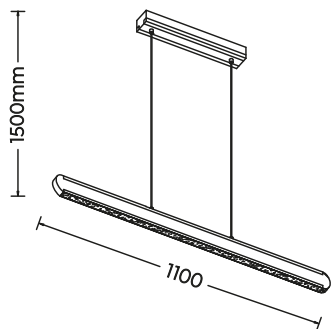

Pendelleuchte · Pendant  
incl. SMD-LED  
42 W / 5.000 Lumen  
2.700 + 4.000 + 6.500 Kelvin  
326610232

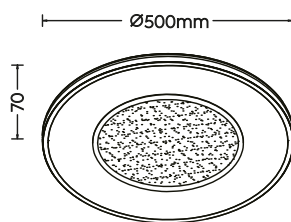

Deckenleuchte · Ceiling lamp  
incl. SMD-LED  
37 W / 4.400 Lumen  
3.000 Kelvin  
626610232



Metall, Holz · metal, wood

32 | Schwarz matt · black mat



4 fach TOUCH ·  
4 level Touch function

Holz, Metall Schwarz matt ·  
wood, metal black mat



**30** | holzfarbig · wood coloured

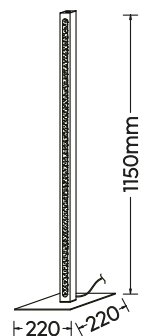
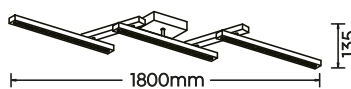

Deckenleuchte · Ceiling lamp  
incl. SMD-LED  
36 W / 4.200 Lumen  
2.700 - 6.000 Kelvin  
**626410530**



Stehleuchte · Floor lamp  
incl. SMD-LED  
20 W / 2.300 Lumen  
3.000 Kelvin  
**426410130**







# DEKORATIVE LEUCHTEN-SERIEN & KOMBINATIONEN

## DECORATIVE LIGHTING SERIES & COMBINATIONS

Die Wahl der richtigen Beleuchtung kann das Ambiente eines Raumes erheblich beeinflussen. Ob aus Metall, Glas oder Holz – die Materialien und Formen sind vielfältig und bieten für jeden Geschmack und Einrichtungsstil das passende Modell.

Choosing the right lighting can have a significant impact on the ambience of a room. Whether made of metal, glass or wood - the materials and shapes are varied and offer the right model for every taste and furnishing style.





# CELESTE NEW

Die CELESTE-Leuchten bestehen durch ihre elegante und grazile Erscheinung, die das gesamte Wohnambiente positiv beeinflusst.

The CELESTE luminaires impress with their elegant and graceful appearance, which has a positive effect on the entire living ambience.



## LIFT ME

Innovative Höhenverstellung ohne Gegengewicht.

## LIFT ME

Innovative height adjustment without counterweight.



## 4 fach TOUCH

Diese Leuchte ist durch Berührung in 4 Helligkeitsstufen schaltbar.

## 4 level Touch function

This light fitting has a touch switch for 4 light intensity levels.

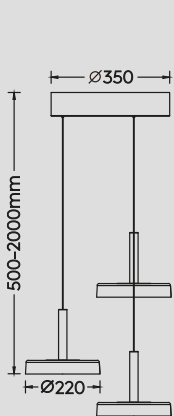

Pendelleuchte · Pendant  
incl. SMD-LED  
3 x 7,5 W / 3 x 750 Lumen  
3.000 Kelvin  
**354930332**  
**354930365**



Stehleuchte · Floor lamp  
incl. SMD-LED  
15 W / 1.750 Lumen  
3.000 Kelvin  
**454910132**  
**454910165**

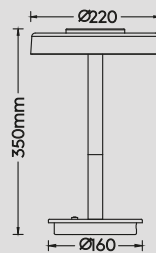

Tischleuchte · Table lamp  
incl. SMD-LED  
10 W / 1.050 Lumen  
3.000 Kelvin  
**554910132**  
**554910165**





Metall, Glas chrom bedampft, Holz ·  
metal, chrome plated glass, wood

**32** | Schwarz matt · black mat

Metall, Glas weiß ·  
metal, white glass

**65** | Coffee · coffee





**SWITCH DIMMER**

Helligkeit in 3 Stufen mit herkömmlichem Lichtschalter einstellbar.

Brightness adjustable in 4 levels with conventional light switch.



**LIFT ME**

Innovative Höhenverstellung ohne Gegengewicht.

**LIFT ME**  
Innovative height adjustment without counterweight.

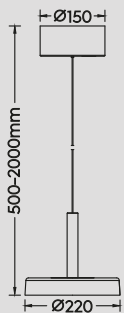

Pendelleuchte · Pendant  
incl. SMD-LED  
10 W / 1.100 Lumen  
3.000 Kelvin  
354910132  
354910165

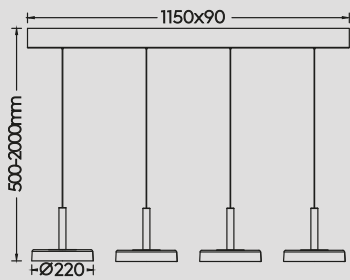

Pendelleuchte · Pendant  
incl. SMD-LED  
4 x 7,5 W / 4 x 750 Lumen  
3.000 Kelvin  
354910432  
354910465

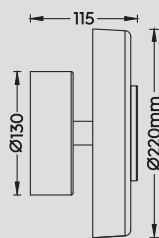

Wandleuchte · Wall lamp  
incl. SMD-LED  
10 W / 1.100 Lumen  
3.000 Kelvin  
254910132  
254910165

Metall, Glas chrom bedampft, Holz - metal, chrome plated glass, wood

32 | Schwarz matt · black mat

Metall, Glas weiß - metal, white glass

65 | Coffee · coffee





# FIATO NEW

Dank der Kaffee-Farben bleibt FIATO im monochromen Look und zieht dennoch mit den drei Nuancen alle Blicke auf sich.

Thanks to the coffee colours, FIATO retains a monochrome look and yet attracts everyone's attention with its three shades.

Metall · metal

 17 | mehrfarbig · multicolor

 65 | Coffee · coffee



### DIP SWITCH

Mittels DIP-SWITCH können drei Lichtfarben (Warmweiß, Neutralweiß, Universalweiß) über einen Schalter direkt an der Leuchte eingestellt werden.

The DIP SWITCH directly sets the luminaire's three light colours (warm, neutral and universal white).



Ø405

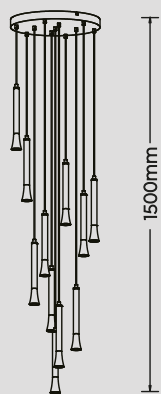

Pendelleuchte · Pendant  
incl. SMD-LED  
11 x 3 W / 11 x 400 Lumen  
2.300 + 3.000 + 4.000 Kelvin  
352091117

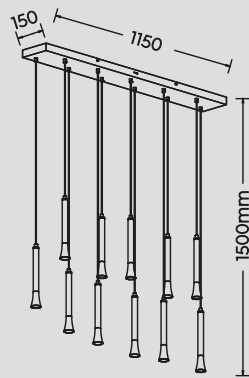

Pendelleuchte · Pendant  
incl. SMD-LED  
11 x 3 W / 11 x 400 Lumen  
2.300 + 3.000 + 4.000 Kelvin  
352011117



Stehleuchte · Floor lamp  
incl. SMD-LED  
3 x 3 W / 3 x 400 Lumen  
2.300 + 3.000 + 4.000 Kelvin  
452010317

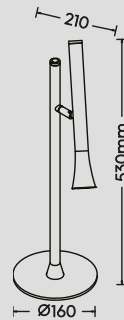

Tischleuchte · Table lamp  
incl. SMD-LED  
3 W / 400 Lumen  
2.300 + 3.000 + 4.000 Kelvin  
552010165





Lichtfarbe einstellbar ·  
Adjustable light color



Sensordimmer ·  
Sensor dimmer



# CHARIVARI

Diese Leuchten zeichnen sich durch ihre exklusive Verarbeitung und außergewöhnliches Designs aus, die sofort ins Auge fallen und für eine luxuriöse Atmosphäre sorgen.

These lights are characterised by their exclusive finish and unusual design, which immediately catch the eye and create a luxurious atmosphere.



## SWITCH DIMMER

Helligkeit in 3 Stufen mit herkömmlichem Lichtschalter einstellbar.

Brightness adjustable in 4 levels with conventional light switch.

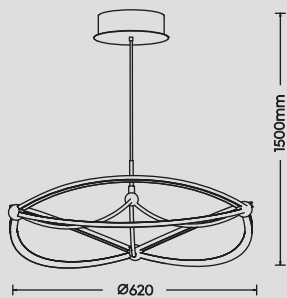
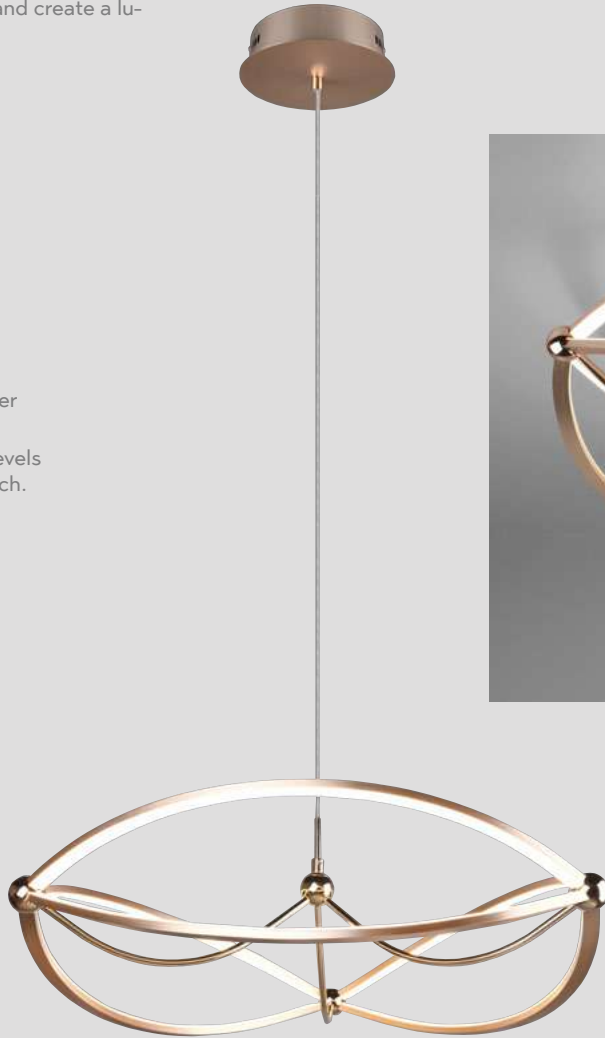

Pendelleuchte · Pendant

incl. SMD-LED  
42 W / 5.600 Lumen  
3.000 Kelvin

321210107  
321210108

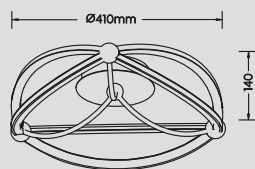

Deckenleuchte · Ceiling lamp

incl. SMD-LED  
20 W / 2.500 Lumen  
3.000 Kelvin

621210107  
621210108

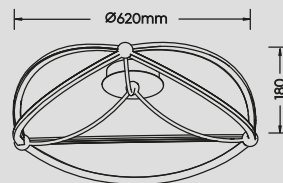

Deckenleuchte · Ceiling lamp

incl. SMD-LED  
42 W / 5.600 Lumen  
3.000 Kelvin

621290107  
621290108

Metall · metal

07 | Nickel matt · nickel mat

08 | Messing matt · brass mat



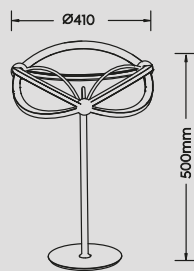

Tischleuchte · Table lamp  
 incl. SMD-LED  
 26 W / 2.500 Lumen  
 3.000 Kelvin  
**521210107**  
**521210108**

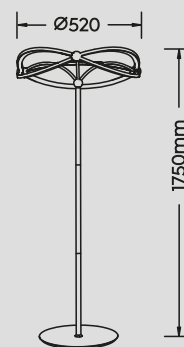

Stehleuchte · Floor lamp  
 incl. SMD-LED  
 31 W / 4.100 Lumen  
 3.000 Kelvin  
**421210107**  
**421210108**



# SEQUENCE

Die Leuchterserie SEQUENCE beeindruckt durch ihr außergewöhnliches Design und bietet vielfältige Möglichkeiten für kreative Kombinationen. Diese Serie zeichnet sich durch innovative Formen und hochwertige Materialien aus, die zusammen eine einzigartige und stilvolle Optik schaffen.

The SEQUENCE luminaire series impresses with its extraordinary design and offers a wide range of options for creative combinations. This series is characterised by innovative shapes and high-quality materials, which together create a unique and stylish look.

Metall · metal

05 | Aluminium gebürstet · brushed Aluminium

08 | Messing matt · brass mat



 Sensordimmer · Sensor dimmer

 Lichtfarbe einstellbar · Adjustable light color

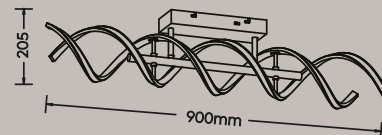

Stehleuchte · Floor lamp  
incl. SMD-LED  
32 W / 4.000 Lumen  
2.300 + 3.000 + 4.000 Kelvin  
441810205  
441810208

Tischleuchte · Table lamp  
incl. SMD-LED  
20,5 W / 2.600 Lumen  
2.300 + 3.000 + 4.000 Kelvin  
541810205  
541810208

Deckenleuchte · Ceiling lamp  
incl. SMD-LED  
41 W / 5.000 Lumen  
2.300 + 3.000 + 4.000 Kelvin  
641810205  
641810208







#### SWITCH DIMMER

Helligkeit in 3 Stufen mit herkömmlichem Lichtschalter einstellbar.

Brightness adjustable in 4 levels with conventional light switch.



#### DIP SWITCH

Mittels DIP-SWITCH können drei Lichtfarben (Warmweiß, Neutralweiß, Tageslichtweiß) über einen Schalter direkt an der Leuchte eingestellt werden.

The DIP SWITCH directly sets the luminaire's three light colours (warm, neutral and daylight white).

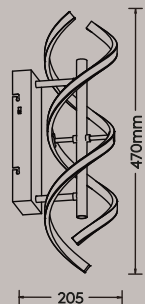

Wandleuchte · Wall lamp  
incl. SMD-LED  
22 W / 2.800 Lumen  
2.300 + 3.000 + 4.000 Kelvin  
**241810205**  
**241810208**

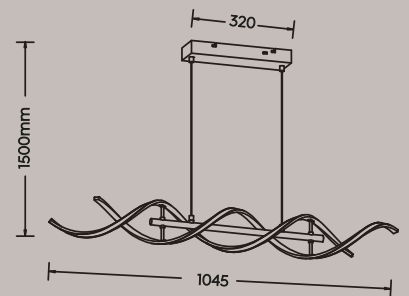

Pendelleuchte · Pendant  
incl. SMD-LED  
45 W / 5.600 Lumen  
2.300 + 3.000 + 4.000 Kelvin  
**341810205**  
**341810208**



# BLAZE

Geschwungene Linien und metallische Farbkombinationen hauchen der BLAZE Leben ein.

Curved lines and metallic colour combinations breathe life into the BLAZE.



Metall, Schwarz matt · metal, black mat

05 | Aluminium gebürstet · brushed Aluminium

08 | Messing matt · brass mat

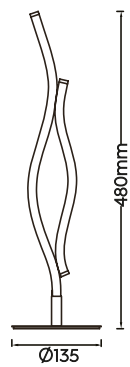
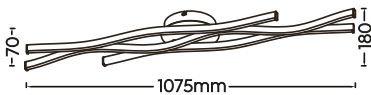

Deckenleuchte · Ceiling lamp

incl. SMD-LED  
35 W / 4.300 Lumen  
2.300 + 3.000 + 4.000 Kelvin

641210305  
641210308

Tischleuchte · Table lamp

incl. SMD-LED  
8 W / 900 Lumen  
2.300 + 3.000 + 4.000 Kelvin

541210205  
541210208

Stehleuchte · Floor lamp

incl. SMD-LED  
28 W / 3.250 Lumen  
2.300 + 3.000 + 4.000 Kelvin

441210305  
441210308





#### DIP SWITCH

Mittels DIP-SWITCH können drei Lichtfarben (Warmweiß, Neutralweiß, Tageslichtweiß) über einen Schalter direkt an der Leuchte eingestellt werden.

The DIP SWITCH directly sets the luminaire's three light colours (warm, neutral and daylight white).

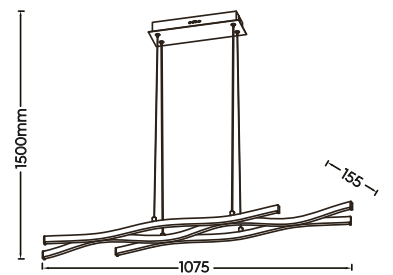

Pendelleuchte · Pendant

incl. SMD-LED

35 W / 4.300 Lumen

2.300 + 3.000 + 4.000 Kelvin

**341210305**

**341210308**



IP20

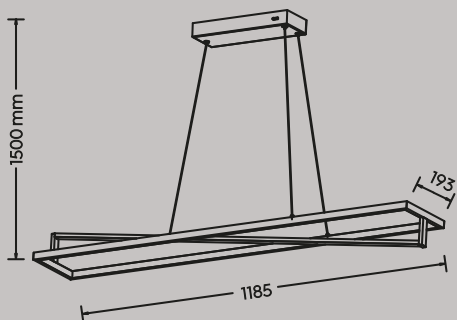

Pendelleuchte · Pendant  
 incl. SMD-LED  
 35 W / 4.100 Lumen  
 2.300 + 3.000 + 4.000 Kelvin  
 326810132



Stehleuchte · Floor lamp  
 incl. SMD-LED  
 26 W / 2.950 Lumen  
 2.300 + 3.000 + 4.000 Kelvin  
 426810132

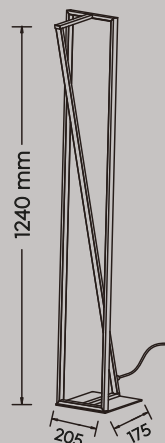



# EDGE

Die klaren Linien und die stilvolle Eleganz integrieren sich nahtlos in moderne Einrichtungsstile und verleihen jedem Raum eine zeitgemäße Note.

The clear lines and stylish elegance integrate seamlessly into modern furnishing styles and give every room a contemporary touch.



## DIP SWITCH

Mittels DIP-SWITCH können drei Lichtfarben (Warmweiß, Neutralweiß, Universalweiß) über einen Schalter direkt an der Leuchte eingestellt werden.

The DIP SWITCH directly sets the luminaire's three light colours (warm, neutral and universal white).

Metall · metal



32 | Schwarz matt / Messing matt ·  
black mat / brass mat



# ALBANY NEW

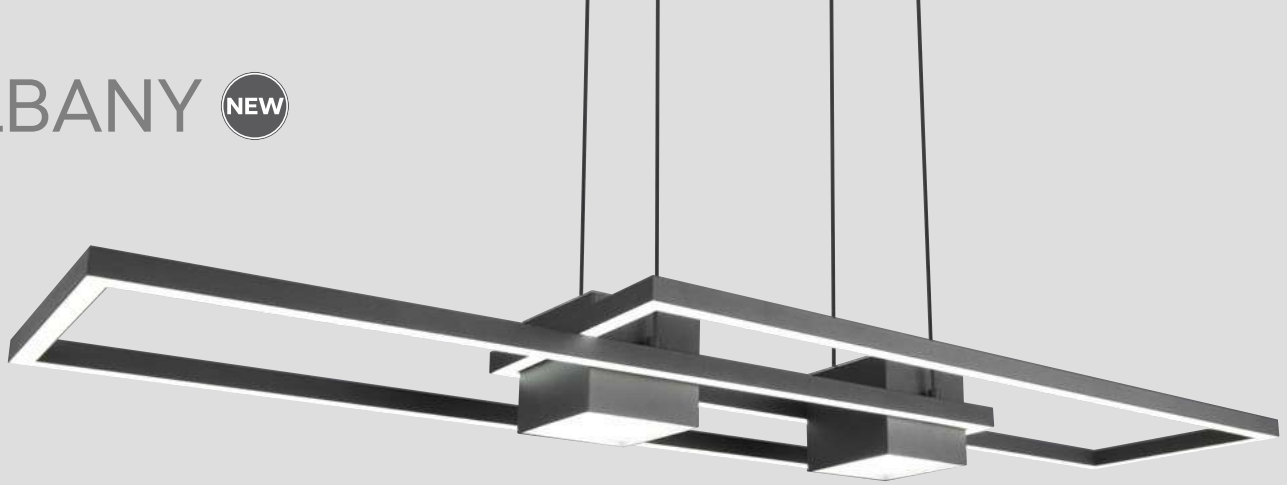

ALBANY vereint modernes Design mit minimalistischer Ästhetik und hoher Funktionalität. Sie fügt sich nahtlos in jede Umgebung ein und sorgt für eine angenehme Beleuchtung.

ALBANY combines modern design with minimalist aesthetics and high functionality. It blends seamlessly into any environment and provides pleasant lighting.



SWITCH DIMMER



Lichtfarbe stufenlos einstellbar ·  
Light color infinitely variable



Memory Funktion ·  
Memory function

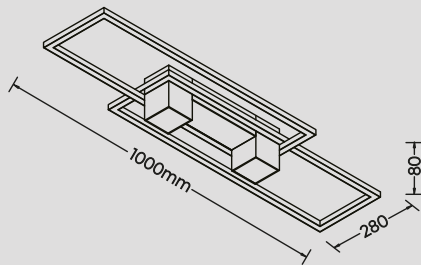
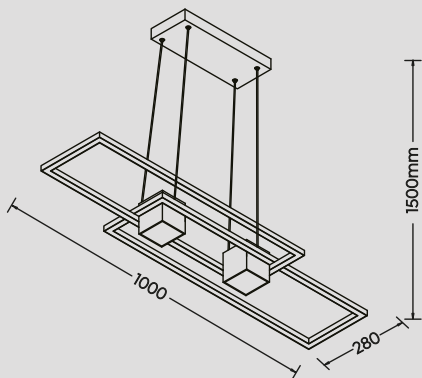
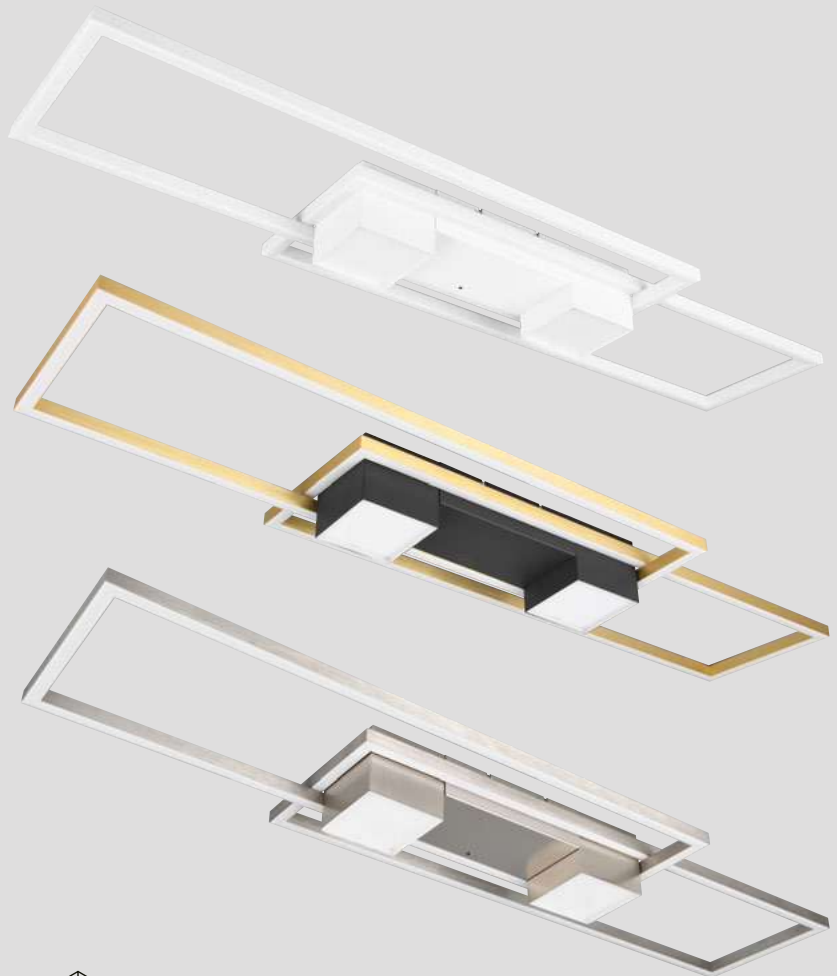

Pendelleuchte · Pendant

incl. SMD-LED  
37 W / 4.300 Lumen  
2.700 - 6.500 Kelvin

347710407  
347710431  
347710432  
347710465  
347710480

Deckenleuchte · Ceiling lamp

incl. SMD-LED  
37 W / 4.300 Lumen  
2.700 - 6.500 Kelvin

647710407  
647710431  
647710432  
647710465  
647710480

Metall · metal



07 | Nickel matt · nickel mat



31 | Weiß matt · white mat



32 | Schwarz matt · black mat



65 | Coffee · coffee



80 | Schwarz-Gold · black-gold



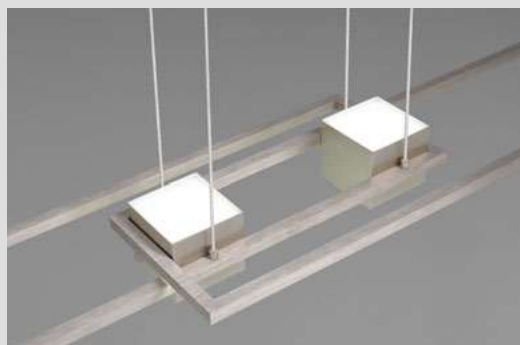

# SALINAS

Die klaren, geometrischen Formen verleihen den Leuchten eine zeitgemäße und stilvolle Optik. Dank der präzisen Lichtverteilung sorgen sie für eine optimale Ausleuchtung und schaffen eine angenehme Atmosphäre in jedem Raum.

The clear, geometric shapes give the lights a contemporary and stylish look. Thanks to the precise light distribution, they provide optimum illumination and create a pleasant atmosphere in any room.

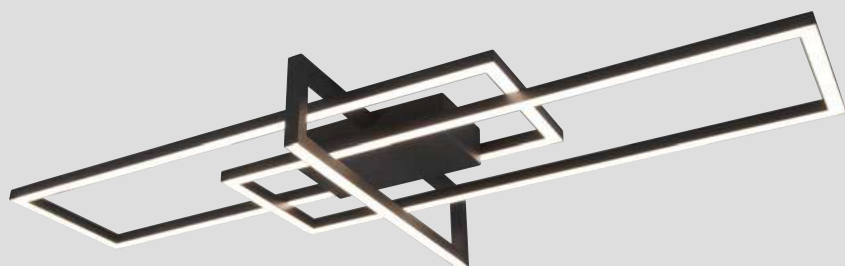
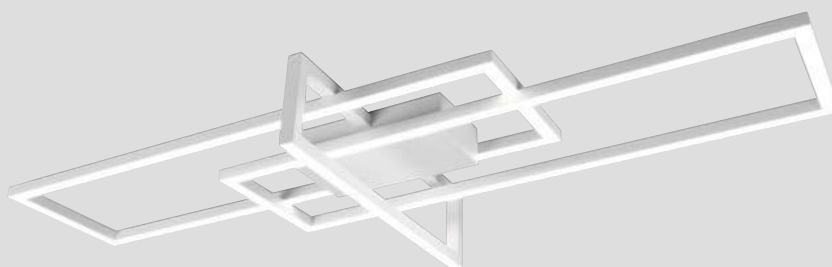
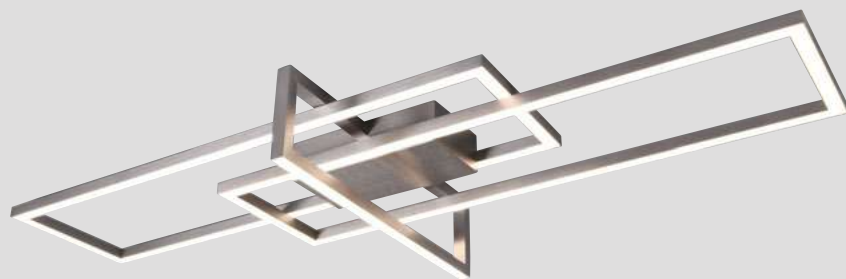

## SWITCH DIMMER

Helligkeit in 3 Stufen mit herkömmlichem Lichtschalter einstellbar.

Brightness adjustable in 4 levels with conventional light switch.

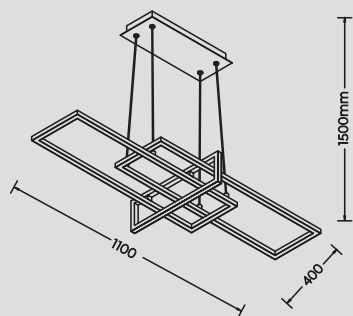
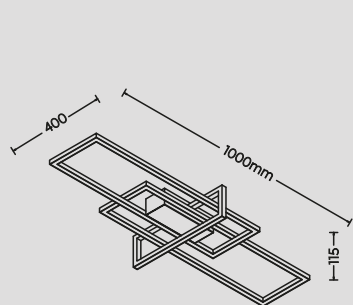

Deckenleuchte · Ceiling lamp

incl. SMD-LED  
34 W / 3.900 Lumen  
3.000 Kelvin

**620310307**

**620310308**

**620310332**

incl. SMD-LED  
34 W / 4.100 Lumen  
4.000 Kelvin

**620310331**

Pendelleuchte · Pendant

incl. SMD-LED  
34 W / 4.200 Lumen  
3.000 Kelvin

**320310307**

**320310308**

**320310332**

incl. SMD-LED  
34 W / 4.400 Lumen  
4.000 Kelvin

**320310331**

Metall · metal



**07** | Nickel matt · nickel mat



**08** | Messing matt / Schwarz matt · brass mat / black mat



**31** | Weiß matt · white mat



**32** | Schwarz matt · black mat







# DARVIN NEW

Die Leuchten kombinieren filigrane Formen mit einer modernen Ästhetik und schaffen so eine harmonische Balance zwischen Funktionalität und Stil.

The lights combine delicate shapes with a modern aesthetic, creating a harmonious balance between functionality and style.



## SWITCH DIMMER

Helligkeit in 3 Stufen mit herkömmlichem Lichtschalter einstellbar.

Brightness adjustable in 4 levels with conventional light switch.

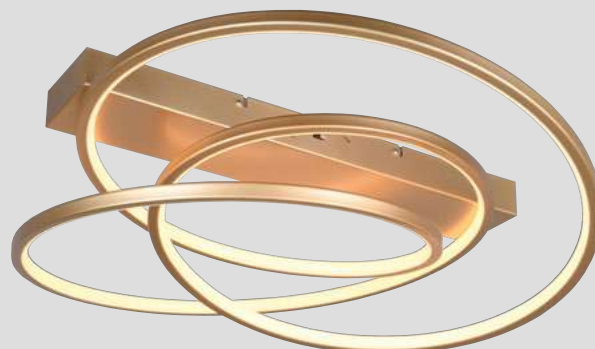

Deckenleuchte · Ceiling lamp

incl. SMD-LED

34 W / 4.500 Lumen

2.300 + 3.000 + 4.000 Kelvin

649110131

649110132

649110179

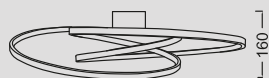
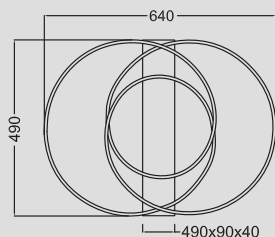

IP20



Metall · metal



**31** | Weiß matt · white mat



**32** | Schwarz matt · black mat



**79** | goldfarbig · gold



#### DIP SWITCH

Mittels DIP-SWITCH können drei Lichtfarben (Warmweiß, Neutralweiß, Universalweiß) über einen Schalter direkt an der Leuchte eingestellt werden.

The DIP SWITCH directly sets the luminaire's three light colours (warm, neutral and universal white).

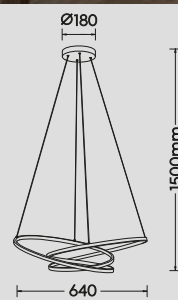

Pendelleuchte · Pendant

incl. SMD-LED  
34 W / 4.500 Lumen  
2.300 + 3.000 + 4.000 Kelvin  
**349110131**  
**349110132**  
**349110179**



IP20

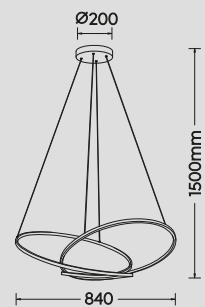

Pendelleuchte · Pendant

incl. SMD-LED  
52 W / 6.700 Lumen  
2.300 + 3.000 + 4.000 Kelvin  
**349119131**  
**349119132**  
**349119179**



IP20

# AARON

Sie haben vergessen das Licht zu Hause auszuschalten? - Kein Problem! Mit der WiZ-App können Sie Ihr Lichtambiente von überall aus steuern.

Forgot to switch off the light at home? - No problem! With the WiZ app, you can control your lighting ambience from anywhere.



RGBW Farbwechsler · RGBW Colorchanging



Lichtfarbe stufenlos einstellbar · Light color infinitely variable



Metall · metal

07 | Nickel matt · nickel mat

42 | Anthrazit · anthracite

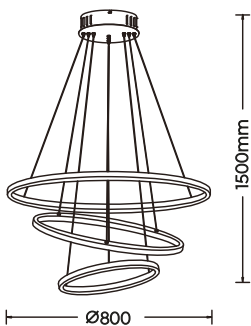
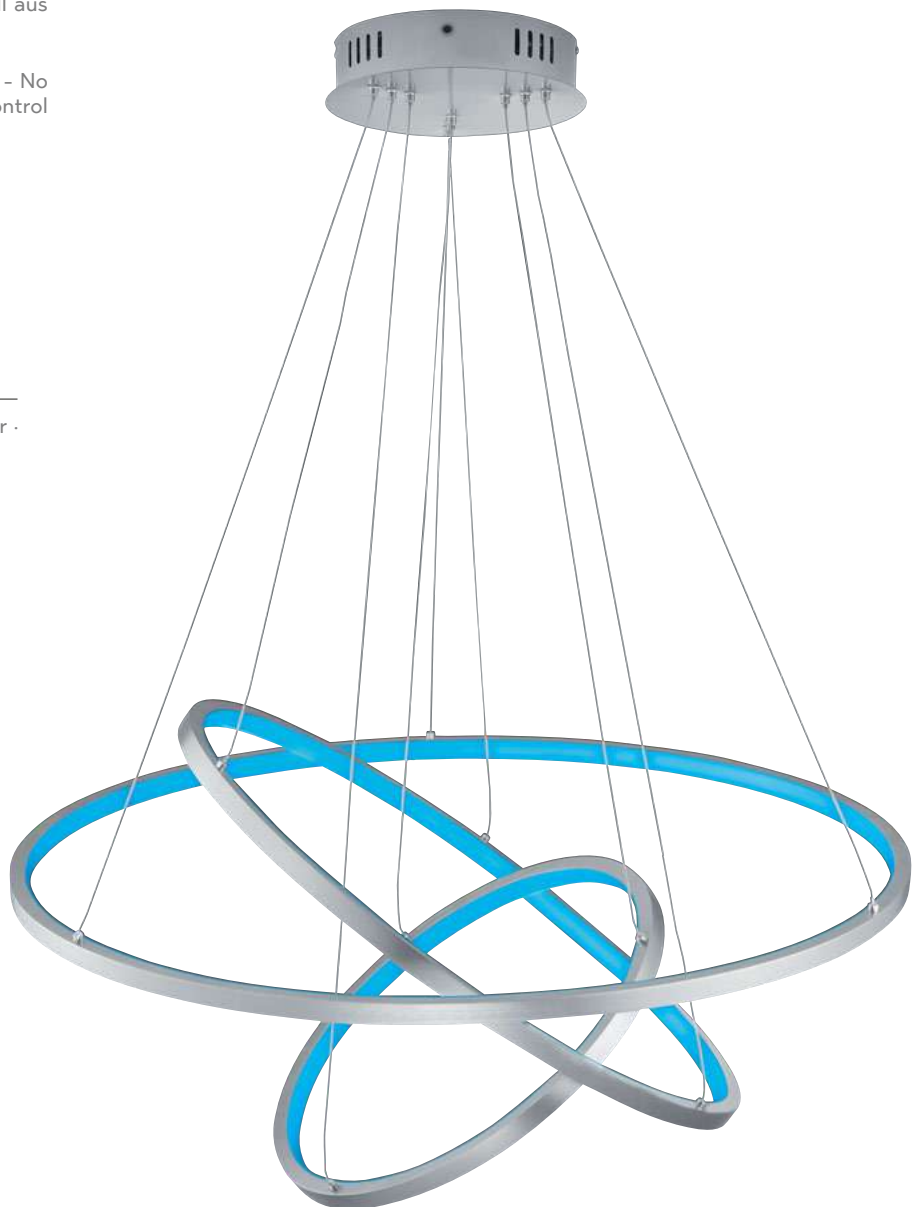

Pendelleuchte · Pendant

incl. RGBW-LED  
78 W / 9.200 Lumen  
3.000 - 6.000 Kelvin

352710307  
352710342

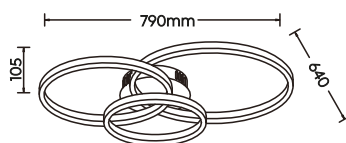

Deckenleuchte · Ceiling lamp

incl. RGBW-LED  
36,5 W / 4.200 Lumen  
3.000 - 6.000 Kelvin

652710307  
652710342



64.000 **WEISSTÖNE**  
64,000 **WHITES**



Einstellbare Lichtprogramme · Preset light modes



16 Millionen **FARBEN**  
16 million **COLORS**



Dynamische Lichtprogramme · Dynamic light modes





# DURBAN

Diese beeindruckende Pendelleuchte mit einem Durchmesser von 80 cm setzt ein echtes Statement in jedem Raum. Ob über dem Esstisch, im Wohnzimmer oder in einem großzügigen Eingangsbereich – diese Leuchte zieht alle Blicke auf sich und verleiht Ihrem Zuhause einen Hauch von Eleganz und Modernität.

This impressive pendant light with a diameter of 80 cm makes a real statement in any room. Whether above the dining table, in the living room or in a spacious entrance area - this light attracts everyone's attention and adds a touch of elegance and modernity to your home.



## SWITCH DIMMER

Helligkeit in 3 Stufen mit herkömmlichem Lichtschalter einstellbar.

Brightness adjustable in 4 levels with conventional light switch.

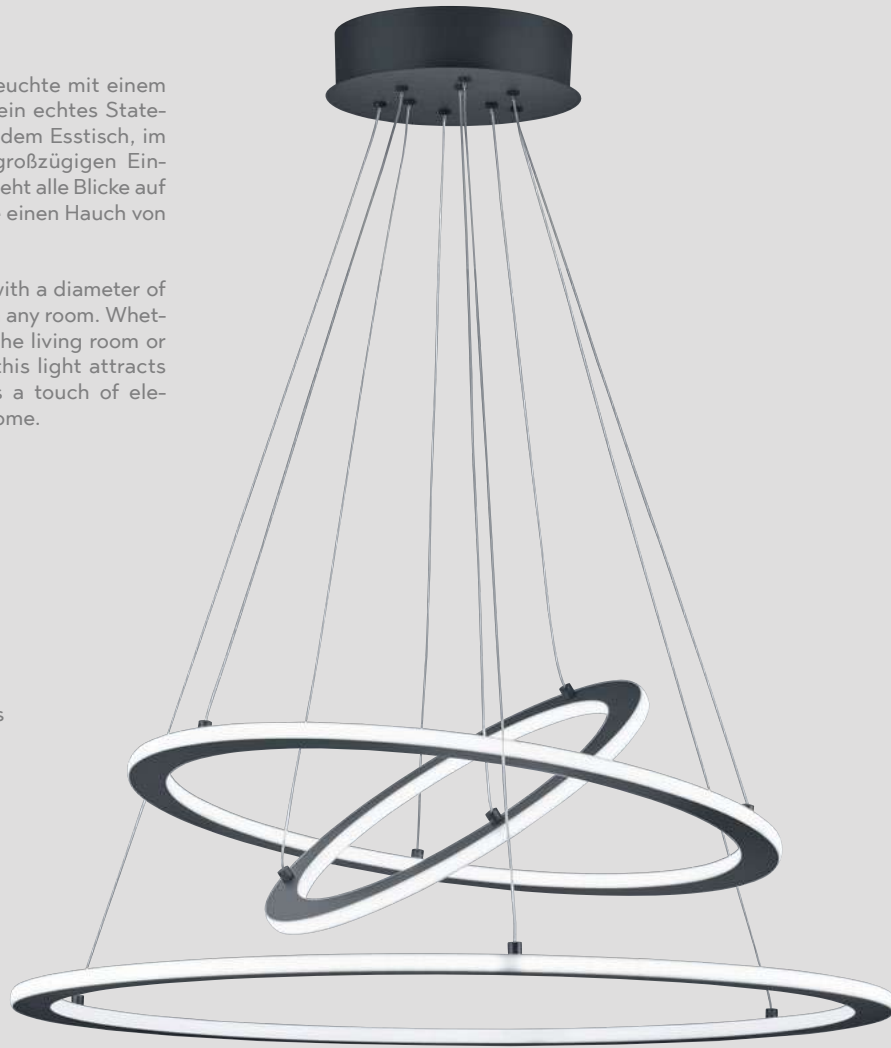

Metall · metal

07 | Nickel matt · nickel mat

42 | Anthrazit · anthracite

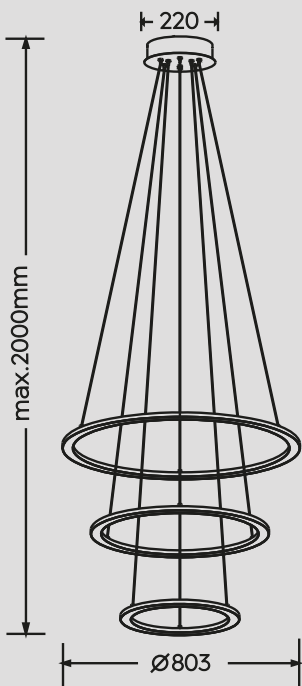
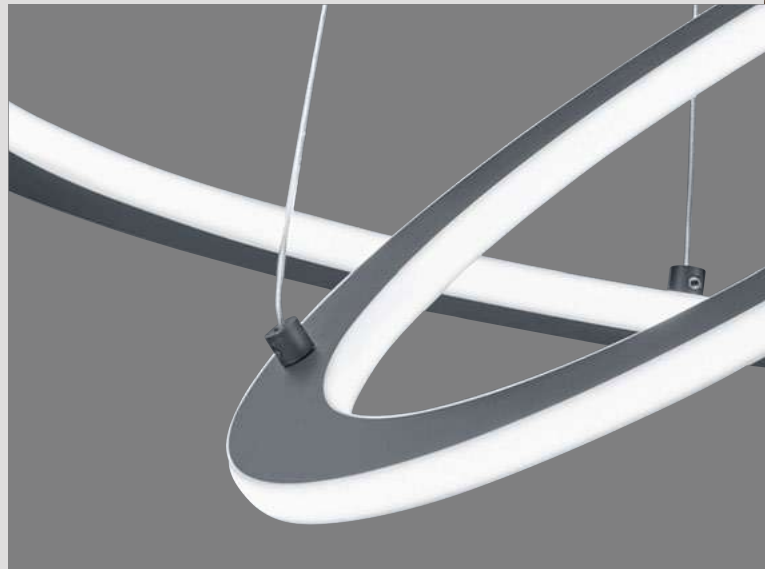

Pendelleuchte · Pendant

incl. SMD-LED

75 W / 8.900 Lumen

3.000 Kelvin

321910307

321910342





# MARNIE

Die geschwungenen Formen schaffen eine harmonische und fließende Optik, die das Auge anzieht und für eine angenehme Atmosphäre sorgt. Dank der hochwertigen Materialien und der präzisen Verarbeitung bieten diese Leuchten nicht nur eine beeindruckende Lichtleistung, sondern auch eine lange Lebensdauer.

The curved shapes create a harmonious and flowing look that attracts the eye and creates a pleasant atmosphere. Thanks to the high-quality materials and precise workmanship, these lights not only offer impressive light output, but also a long service life.



## SWITCH DIMMER

Helligkeit in 3 Stufen mit herkömmlichem Lichtschalter einstellbar.

Brightness adjustable in 4 levels with conventional light switch.

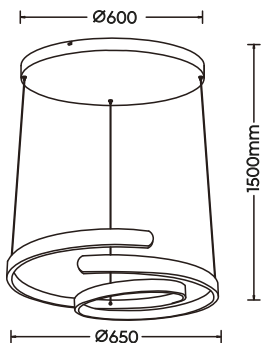
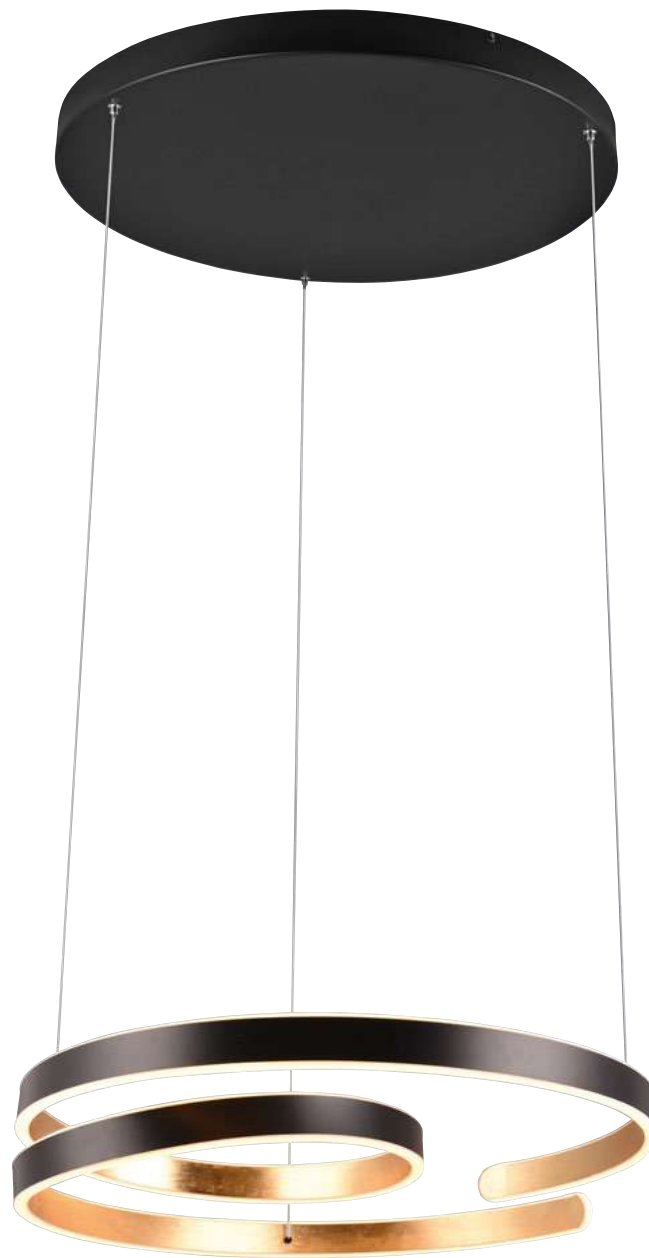

Pendelleuchte · Pendant



incl. SMD-LED  
68 W / 8.000 Lumen  
3.000 Kelvin

344110105

344110165

344110180

Metall · metal

-  05 | Aluminium gebürstet · brushed Aluminium
-  65 | Coffee · coffee
-  80 | Schwarz-Gold · black-gold



IP20



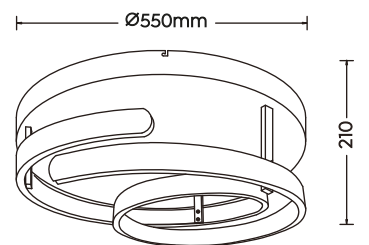

Deckenleuchte · Ceiling lamp

incl. SMD-LED  
58 W / 6.800 Lumen  
3.000 Kelvin

**644110105**

**644110165**

**644110180**



IP20

# FRANCIS

Mit ihrem modernen und außergewöhnlichen Design, verleiht die FRANCIS jedem Raum ihren eigenen Charme.

With its modern and unusual design, the FRANCIS lends every room its own charm.



## SWITCH DIMMER

Helligkeit in 3 Stufen mit herkömmlichem Lichtschalter einstellbar.

Brightness adjustable in 4 levels with conventional light switch.

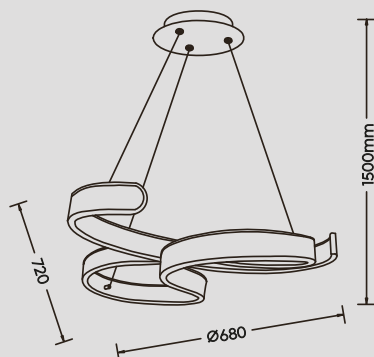
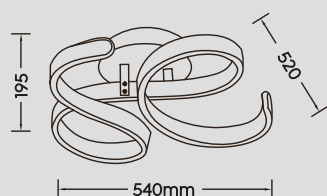

Deckenleuchte · Ceiling lamp

incl. SMD-LED  
40 W / 4.650 Lumen  
3.000 Kelvin

671310105

671310131

671310142

Pendelleuchte · Pendant

incl. SMD-LED  
48 W / 5.600 Lumen  
3.000 Kelvin

371310105

371310131

371310142

Metall · metal

05 | Aluminium gebürstet · brushed Aluminium

31 | Weiß matt · white mat

42 | Anthrazit · anthracite



# OAKLAND

Die Leuchten bestechen durch ihre hervorragenden Lichteigenschaften und ihr außergewöhnliches, modernes Design. Mit einer klaren und effizienten Lichtverteilung sorgen sie für eine optimale Ausleuchtung jedes Raumes.

The luminaires impress with their outstanding lighting properties and their unusual, modern design. With clear and efficient light distribution, they ensure optimum illumination of any room.

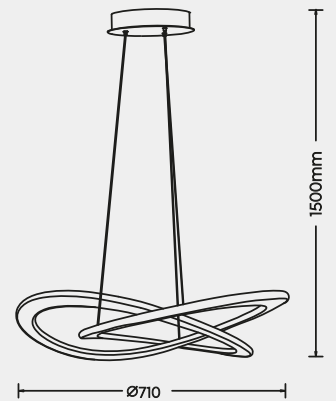

## SWITCH DIMMER

Helligkeit in 3 Stufen mit herkömmlichem Lichtschalter einstellbar.

Brightness adjustable in 4 levels with conventional light switch.

Metall · metal



07 | Nickel matt · nickel mat



42 | Anthrazit · anthracite

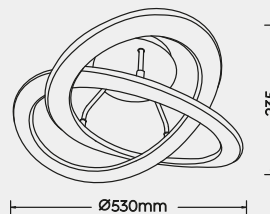

## Deckenleuchte · Ceiling lamp

incl. SMD-LED  
40 W / 5.200 Lumen  
3.000 Kelvin

621710107  
621710142



IP20



## Pendelleuchte · Pendant

incl. SMD-LED  
52 W / 6.200 Lumen  
3.000 Kelvin

321710107  
321710142



IP20

# SYDNEY

Metall, Acryl · metal, acryl

06 | Chrome · chrome

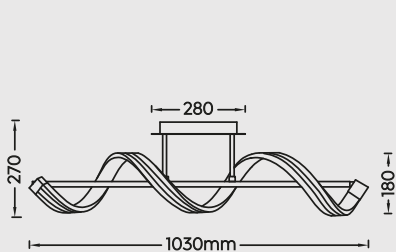

Deckenleuchte · Ceiling lamp  
incl. SMD-LED  
18 W / 2.000 Lumen  
3.000 Kelvin  
672910106



IP20



Tischleuchte · Table lamp  
incl. SMD-LED  
12 W / 1.300 Lumen  
3.000 Kelvin  
572910106



IP20



Stehleuchte · Floor lamp  
incl. SMD-LED  
22 W / 2.500 Lumen  
3.000 Kelvin  
472910106



IP20

# CARRERA

Die geschwungenen Formen und eleganten Linien bringen Bewegung und Lebendigkeit in jeden Raum.

The curved shapes and elegant lines bring movement and vibrancy to any room.



## SWITCH DIMMER

Helligkeit in 3 Stufen mit herkömmlichem Lichtschalter einstellbar.

Brightness adjustable in 4 levels with conventional light switch.

Metall, Acryl · metal, acryl



05 | Aluminium gebürstet · brushed Aluminium



32 | Schwarz matt · black mat

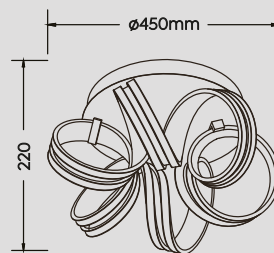

Deckenleuchte · Ceiling lamp  
incl. SMD-LED  
38 W / 4.400 Lumen  
3.000 Kelvin  
**625010105**



IP20

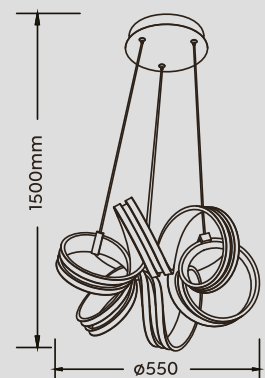

Pendelleuchte · Pendant  
incl. SMD-LED  
38 W / 4.400 Lumen  
3.000 Kelvin  
**325010105**  
**325010132**



IP20

# NURIA

Mit ihrer Kombination aus dynamischem Design und hervorragenden Lichteigenschaften sind sie die ideale Wahl für alle, die Wert auf Qualität und Stil legen.

With their combination of dynamic design and outstanding lighting properties, they are the ideal choice for anyone who values quality and style.

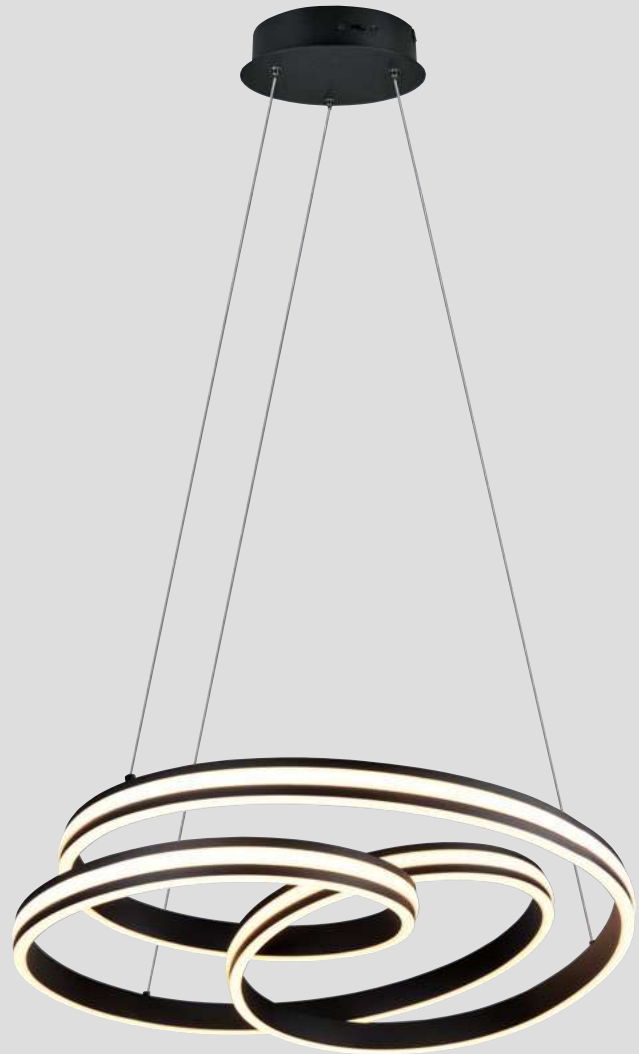

Metall, Acryl · metal, acryl

07 | Nickel matt · nickel mat

32 | Schwarz matt · black mat

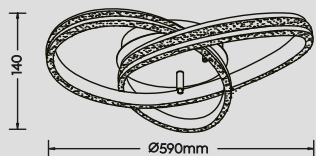

Deckenleuchte · Ceiling lamp

incl. SMD-LED

58 W / 7.000 Lumen

2.300 + 3.000 + 4.000 Kelvin

626210107

626210132

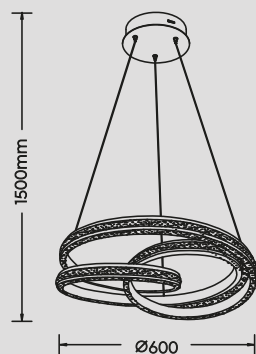

Pendelleuchte · Pendant

incl. SMD-LED

60 W / 7.200 Lumen

2.300 + 3.000 + 4.000 Kelvin

326210107

326210132



Stehleuchte · Floor lamp

incl. SMD-LED

34 W / 4.000 Lumen

2.300 + 3.000 + 4.000 Kelvin

426219107

426219132





#### DIP SWITCH

Mittels DIP-SWITCH können drei Lichtfarben (Warmweiß, Neutralweiß, Universalweiß) über einen Schalter direkt an der Leuchte eingestellt werden.

The DIP SWITCH directly sets the luminaire's three light colours (warm, neutral and universal white).

# RONDO

Die Ringe erzeugen eine harmonische und fließende Optik, die das Licht auf faszinierende Weise verteilt. Diese dynamischen Formen verleihen den Leuchten eine besondere Lebendigkeit und machen sie zu einem echten Blickfang.

The rings create a harmonious and flowing look that distributes the light in a fascinating way. These dynamic shapes give the lights a special vibrancy and make them a real eye-catcher.



Metall · metal

 **31** | Weiß matt · white mat

 **32** | Schwarz matt · black mat



Integrierter Dimmer ·  
Integrated dimmer

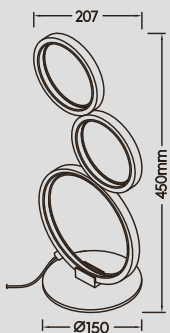

Tischleuchte · Table lamp

incl. SMD-LED  
17 W / 1.900 Lumen  
3.000 Kelvin

**522610331**  
**522610332**

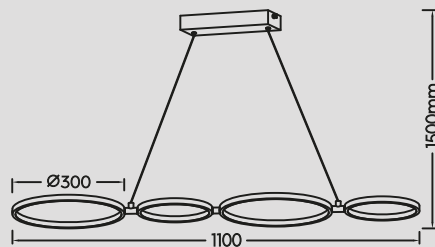

Pendelleuchte · Pendant

incl. SMD-LED  
37 W / 4.600 Lumen  
3.000 Kelvin

**322610431**  
**322610432**

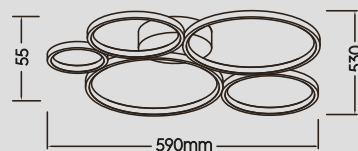

Deckenleuchte · Ceiling lamp

incl. SMD-LED  
49 W / 5.800 Lumen  
3.000 Kelvin

**622610531**  
**622610532**





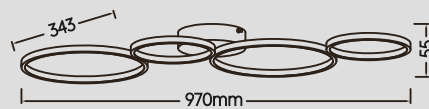

Deckenleuchte · Ceiling lamp  
 incl. SMD-LED  
 37 W / 4.800 Lumen  
 3.000 Kelvin  
**622610431**  
**622610432**



Stehleuchte · Floor lamp  
 incl. SMD-LED  
 36 W / 4.700 Lumen  
 3.000 Kelvin  
**422610531**  
**422610532**



# JIVE

Die schwungvolle JIVE verkörpert stilvolle Leichtigkeit und passt perfekt in moderne Einrichtungsstile.

The sweeping JIVE embodies stylish lightness and fits perfectly into modern furnishing styles.



Metall, Acryl · metal, acryl

 **07** | Nickel matt · nickel mat

 **31** | Weiß matt · white mat

 **32** | Schwarz matt · black mat



Lichtfarbe stufenlos einstellbar ·  
Light color infinitely variable



Integrierter Dimmer ·  
Integrated dimmer

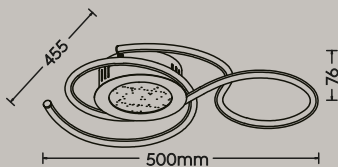

Deckenleuchte · Ceiling lamp

incl. SMD-LED  
36 W / 4.300 Lumen  
2.700 - 6.000 Kelvin

6234102**07**

6234102**31**

6234102**32**

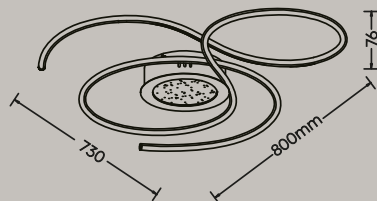

Deckenleuchte · Ceiling lamp

incl. SMD-LED  
48 W / 5.600 Lumen  
2.700 - 6.000 Kelvin

6234192**07**

6234192**32**



Stehleuchte · Floor lamp

incl. SMD-LED  
23 W / 2.700 Lumen  
2.700 + 4.000 + 6.000 Kelvin

4234101**07**

4234101**31**

4234101**32**





Lichtfarbe stufenweise einstellbar  
2.700 + 4.000 + 6.000 K ·  
In stage adjustable light color  
2.700 + 4.000 + 6.000 K

FLY zeichnet sich durch ihr modernes Design aus, welches an einen abstrakten Schmetterling mit ausgebreiteten Flügeln erinnert.

FLY is characterised by its modern design, which is reminiscent of an abstract butterfly with outstretched wings.



## SWITCH DIMMER

Helligkeit in 3 Stufen mit herkömmlichem Lichtschalter einstellbar.

Brightness adjustable in 4 levels with conventional light switch.



Metall, Acryl · metal, acryl

 **31** | Weiß matt · white mat

 **32** | Schwarz matt · black mat

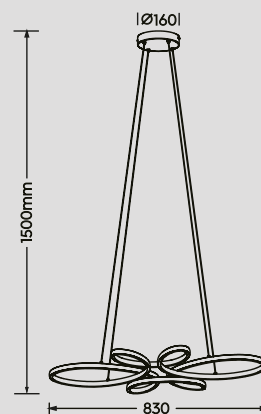
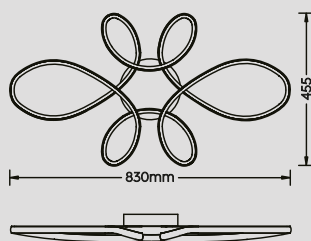
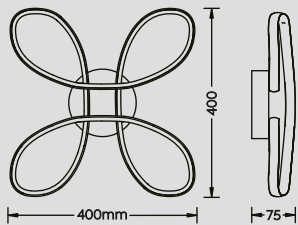

Deckenleuchte · Ceiling lamp

incl. SMD-LED  
22 W / 2.600 Lumen  
4.000 Kelvin

**645610131**

incl. SMD-LED  
22 W / 2.600 Lumen  
3.000 Kelvin

**645610132**

Deckenleuchte · Ceiling lamp

incl. SMD-LED  
32 W / 3.900 Lumen  
4.000 Kelvin

**645619131**

incl. SMD-LED  
32 W / 3.900 Lumen  
3.000 Kelvin

**645619132**

Pendelleuchte · Pendant

incl. SMD-LED  
32 W / 3.900 Lumen  
4.000 Kelvin

**345619131**

incl. SMD-LED  
32 W / 3.900 Lumen  
3.000 Kelvin

**345619132**









# CARDONA NEW

Die Leuchten zeichnen sich durch ihr rundes, minimalistisches Design aus. Sie bieten eine klare Ästhetik und brillantes Licht.

The luminaires are characterised by their round, minimalist design. They offer clear aesthetics and brilliant light.

Metall · metal

 **31** | Weiß matt · white mat

 **32** | Schwarz matt · black mat

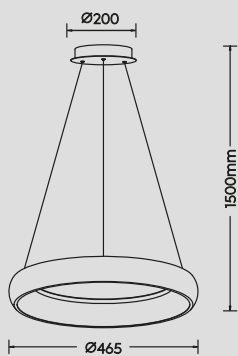

Pendelleuchte · Pendant

incl. SMD-LED

29 W / 3.300 Lumen

2.300 + 3.000 + 4.000 Kelvin

**349614531**

**349614532**

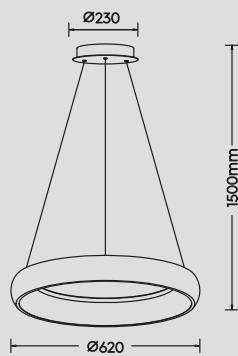

Pendelleuchte · Pendant

incl. SMD-LED

38 W / 4.400 Lumen

2.300 + 3.000 + 4.000 Kelvin

**349616031**

**349616032**

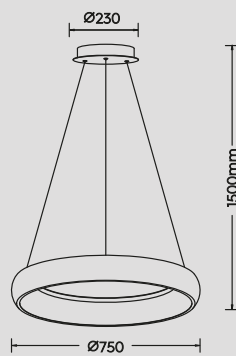

Pendelleuchte · Pendant

incl. SMD-LED

59 W / 6.900 Lumen

2.300 + 3.000 + 4.000 Kelvin

**349617531**

**349617532**







#### DIP SWITCH

Mittels DIP-SWITCH können drei Lichtfarben (Warmweiß, Neutralweiß, Universalweiß) über einen Schalter direkt an der Leuchte eingestellt werden.

The DIP SWITCH directly sets the luminaire's three light colours (warm, neutral and universal white).



#### SWITCH DIMMER

Helligkeit in 3 Stufen mit herkömmlichem Lichtschalter einstellbar.

Brightness adjustable in 4 levels with conventional light switch.



## SWITCH DIMMER

Helligkeit in 3 Stufen mit herkömmlichem Lichtschalter einstellbar.

Brightness adjustable in 4 levels with conventional light switch.



## DIP SWITCH

Mittels DIP-SWITCH können drei Lichtfarben (Warmweiß, Neutralweiß, Universalweiß) über einen Schalter direkt an der Leuchte eingestellt werden.

The DIP SWITCH directly sets the luminaire's three light colours (warm, neutral and universal white).



Metall · metal



**31** | Weiß matt · white mat



**32** | Schwarz matt · black mat

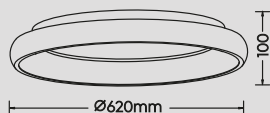

Deckenleuchte · Ceiling lamp

incl. SMD-LED

29 W / 3.300 Lumen

2.300 + 3.000 + 4.000 Kelvin

**649614531**

**649614532**

Deckenleuchte · Ceiling lamp

incl. SMD-LED

38 W / 4.400 Lumen

2.300 + 3.000 + 4.000 Kelvin

**649616031**

**649616032**

Deckenleuchte · Ceiling lamp

incl. SMD-LED

59 W / 6.900 Lumen

2.300 + 3.000 + 4.000 Kelvin

**649617531**

**649617532**





# TUBULAR

Die Pendelleuchte TUBULAR besticht durch ihr puristisches Design und eine klare Formensprache. Ihre schlanke, zylindrische Form fügt sich harmonisch in moderne Einrichtungsstile ein und setzt stilvolle Akzente.

The TUBULAR pendant light impresses with its purist design and clear design language. Its slim, cylindrical shape blends harmoniously into modern furnishing styles and sets stylish accents.



## SWITCH DIMMER

Helligkeit in 3 Stufen mit herkömmlichem Lichtschalter einstellbar.

Brightness adjustable in 4 levels with conventional light switch.

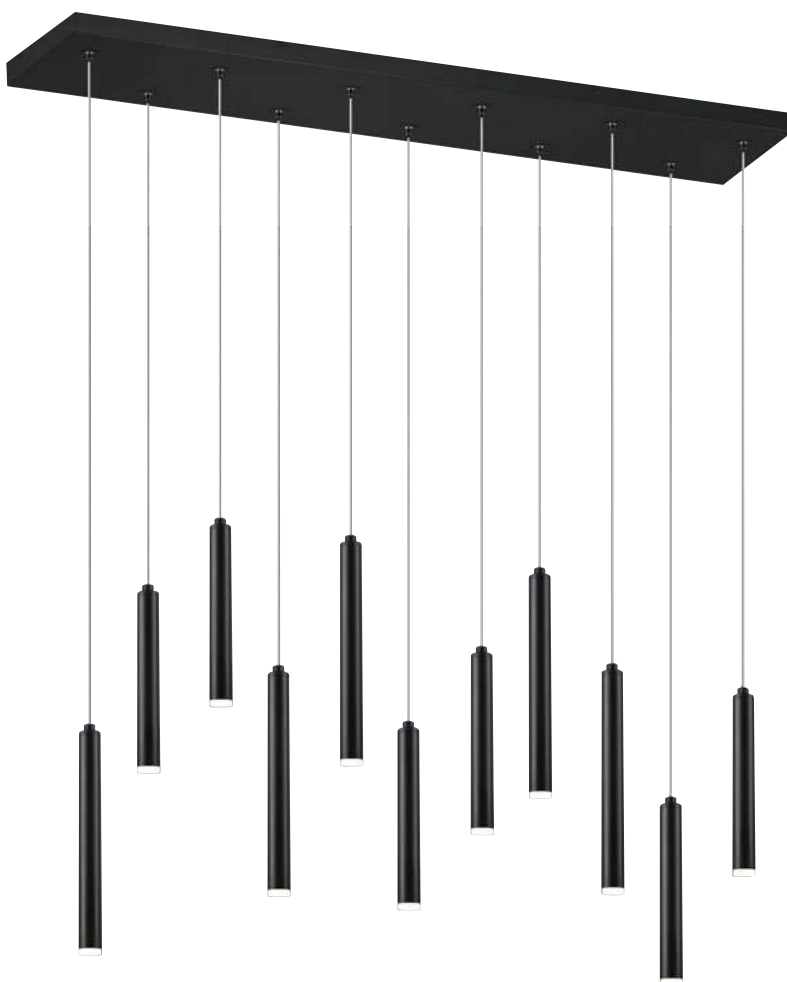

Metall · metal



31 | Weiß matt · white mat



32 | Schwarz matt · black mat

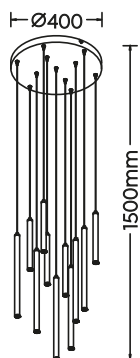

Pendelleuchte · Pendant  
incl. 11 x SMD-LED  
11 x 2,8 W / 11 x 350 Lumen  
3.000 Kelvin  
**321691131**  
**321691132**

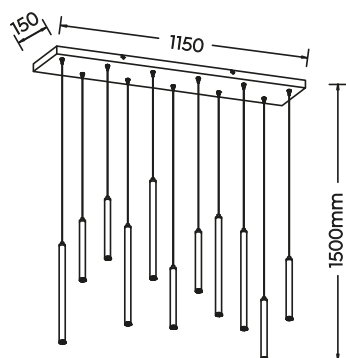

Pendelleuchte · Pendant  
incl. 11 x SMD-LED  
11 x 2,8 W / 11 x 350 Lumen  
3.000 Kelvin  
**321611131**  
**321611132**





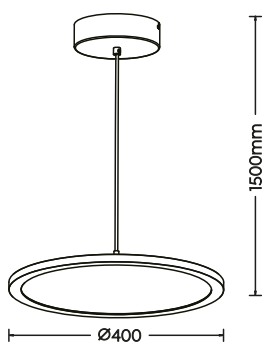

Pendelleuchte · Pendant  
incl. SMD-LED  
29 W / 3.550 Lumen  
3.000 Kelvin  
**340910132**

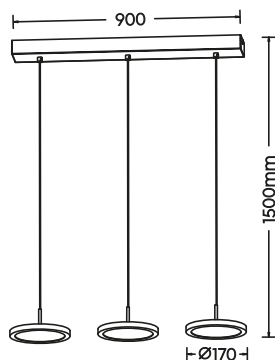

Pendelleuchte · Pendant  
incl. 3 x SMD-LED  
3 x 10 W / 3 x 1.200 Lumen  
3.000 Kelvin  
**340910332**

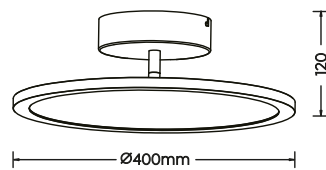

Deckenleuchte · Ceiling lamp  
incl. SMD-LED  
29 W / 3.550 Lumen  
3.000 Kelvin  
**640910132**



Metall · metal



**32** | Schwarz matt · black mat



# TRAY

TRAY steht für puren Minimalismus! Ein absoluter Trend, den man in vielen Einrichtungsstilen wiederfindet.

TRAY stands for pure minimalism! An absolute trend that can be found in many furnishing styles.



Deckenleuchte kippbar ·  
Ceiling lamp tiltable



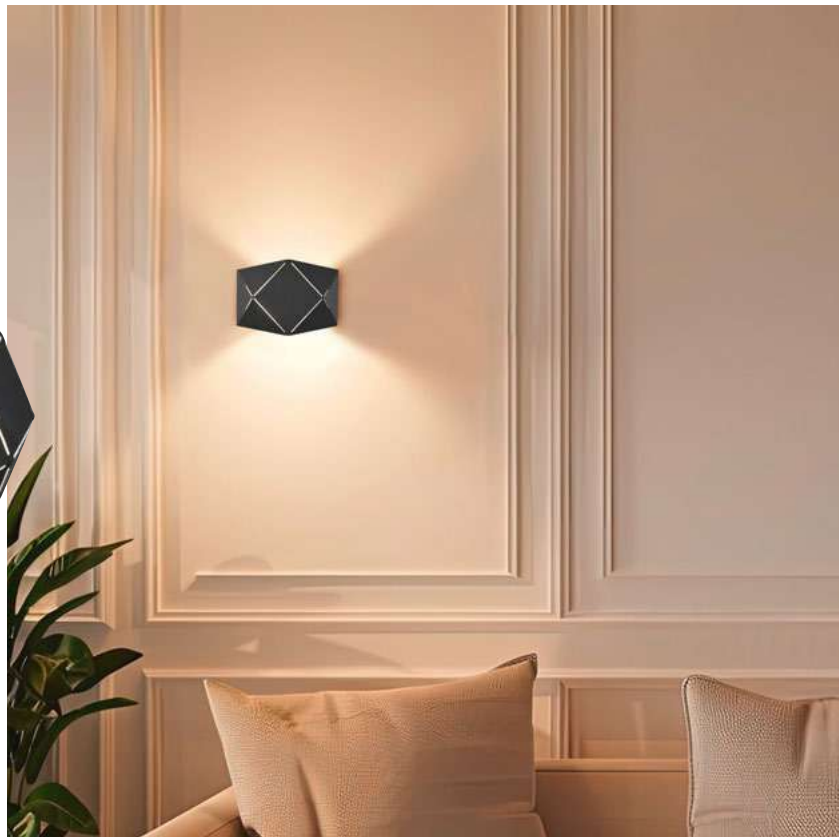

Metall, Acryl · metal, acryl

○ 31 | Weiß matt · white mat

● 32 | Schwarz matt · black mat

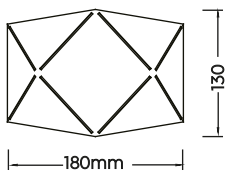

Wandleuchte · Wall lamp  
incl. SMD-LED  
6,5 W / 700 Lumen  
3.000 Kelvin  
223510131  
223510132

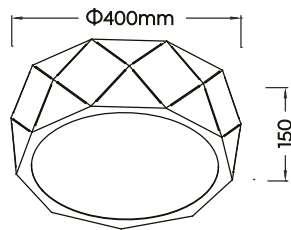

Deckenleuchte · Ceiling lamp  
excl. 3 x E27  
max. 25 W  
603500331  
603500332

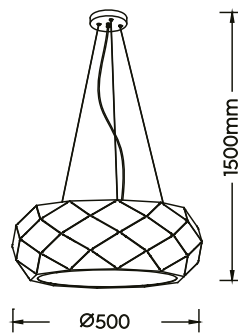

Pendelleuchte · Pendant  
excl. 3 x E27  
max. 25 W  
303500331  
303500332





# ZANDOR

Die Leuchterserie ZANDOR beeindruckt durch ihr einzigartiges Design, das durch die speziellen Aussparungen im Schirm charakterisiert wird. Diese Cut-Outs erzeugen faszinierende Lichtspiele, die sanft an die Wände projiziert werden.

The ZANDOR luminaire series impresses with its unique design, which is characterised by the special cut-outs in the shade. These cut-outs create a fascinating play of light that is gently projected onto the walls.



# BARON

Dank ihrer klassischen Form fügt sich die BARON nahtlos in jeden Einrichtungsstil ein und wird zu einem zeitlosen Wohnobjekt.

Thanks to its classic shape, the BARON blends seamlessly into any interior style and becomes a timeless living object.

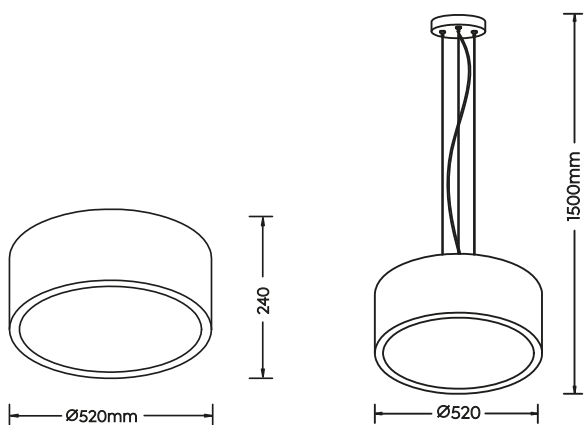

Deckenleuchte · Ceiling lamp

excl. 4 x E27  
max. 40 W

609800431  
609800432

Pendelleuchte · Pendant

excl. 4 x E27  
max. 40 W

309800431  
309800432

Metall, Acryl · metal, acryl

○ 31 | Weiß matt · white mat

● 32 | Schwarz matt · black mat





Dank ihrer großzügigen Länge von 150 cm eignet sie sich perfekt für lange Esstische, Kücheninseln oder große Wohnbereiche. Das moderne Design und die exzellenten Lichteigenschaften machen diese Pendelleuchte zu einem echten Highlight.

Thanks to its generous length of 150 cm, it is perfect for long dining tables, kitchen islands or large living areas. The modern design and excellent lighting properties make this pendant light a real highlight.

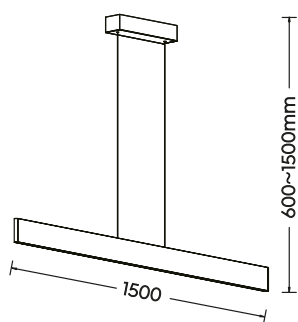
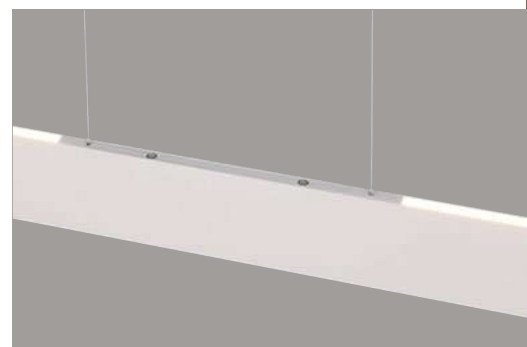

Pendelleuchte · Pendant

incl. SMD-LED  
35 W / 4.200 Lumen  
2.700 - 6.000 Kelvin

349710107

349710132

349710176



#### LIFT ME

Innovative Höhenverstellung ohne Gegengewicht.

#### LIFT ME

Innovative height adjustment without counterweight.



#### Lichtfarbe stufenlos einstellbar

Die Lichtfarbe (Farbtemperatur in Kelvin) ist stufenlos einstellbar.

#### Light color infinitely variable

The illuminant chromaticity (colour temperature in Kelvin) is infinitely variable.



#### 4 fach TOUCH

Diese Leuchte ist durch Berührung in 4 Helligkeitsstufen schaltbar.

#### 4 level Touch function

This light fitting has a touch switch for 4 light intensity levels.

Metall · metal

 **07** | Nickel matt · nickel mat

 **32** | Schwarz matt · black mat

 **76** | Warm Grau · warm grey

GALWAY **NEW**



# TRAJAN

Die Kombination aus Funktionalität und ästhetischem Anspruch macht diese Leuchte zu einer idealen Wahl für alle, die Wert auf Qualität und zeitlose Eleganz legen.

The combination of functionality and aesthetic appeal makes this luminaire an ideal choice for anyone who values quality and timeless elegance.



Lichtfarbe stufenlos einstellbar ·  
Light color infinitely variable



4 fach TOUCH ·  
4 level Touch function



Ausziehbar 95 - 150 cm ·  
Extendible 95 - 150 cm



Höhenverstellbar 95 - 175 cm ·  
Adjustable height 95 - 175 cm

Pendelleuchte · Pendant

incl. SMD-LED  
45 W / 5.300 Lumen  
2.700 - 5.000 Kelvin

375310502

375310505

375310507

375310532





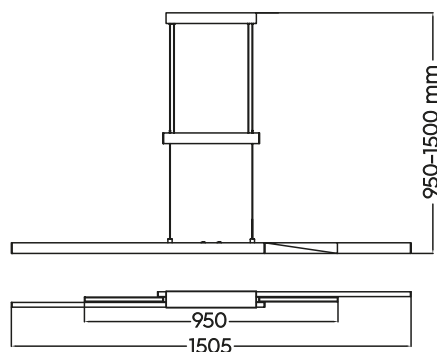

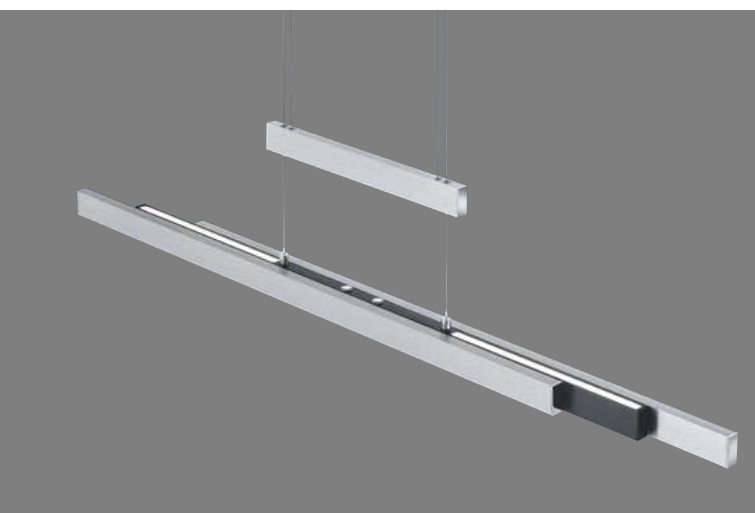
IP20





Metall · metal

-  **02** | Schwarz / Messing matt · black / brass mat
-  **05** | Aluminium gebürstet · brushed Aluminium
-  **07** | Nickel matt · nickel mat
-  **32** | Schwarz matt · black mat

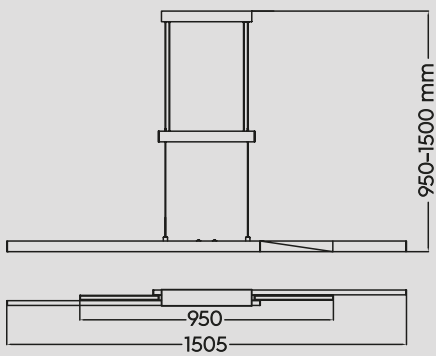

Pendelleuchte · Pendant

incl. SMD-LED  
46 W / 5.800 Lumen  
2.700 - 5.000 Kelvin

375390531  
375390532

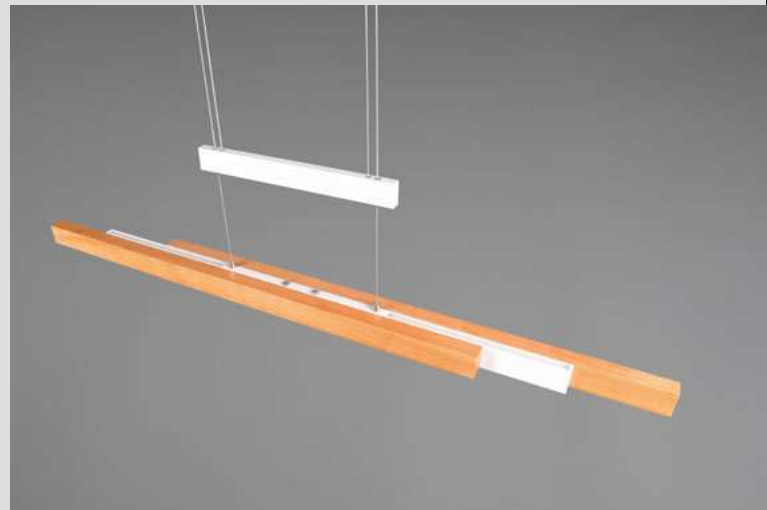

Ausziehbar 95 - 150 cm ·  
Extendible 95 - 150 cm



Höhenverstellbar 95 - 175 cm ·  
Adjustable height 95 - 175 cm

Metall, Holz · metal, wood



**31** | Weiß matt · white mat



**32** | Schwarz matt · black mat



# TRAJAN NEW



Lichtfarbe stufenlos einstellbar ·  
Light color infinitely variable



4 fach TOUCH ·  
4 level Touch function

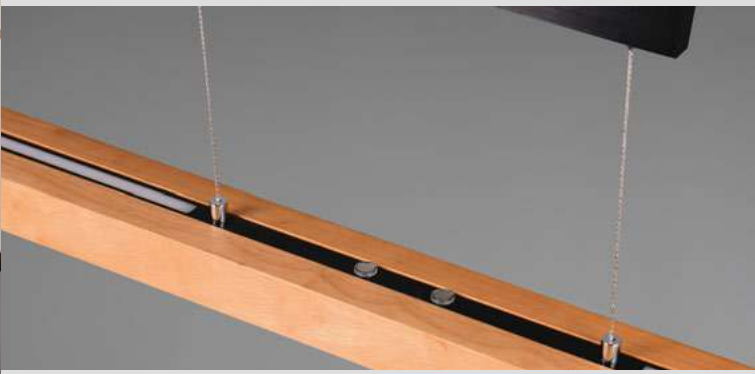

# HELIOS NEW

Ob ausziehbar oder nicht, die HELIOS macht über jedem Tisch eine gute Figur!

Whether extendable or not, the HELIOS cuts a fine figure above any table!



#### 4 fach TOUCH

Diese Leuchte ist durch Berührung in 4 Helligkeitsstufen schaltbar.

#### 4 level Touch function

This light fitting has a touch switch for 4 light intensity levels.



#### Lichtfarbe stufenlos einstellbar

Die Lichtfarbe (Farbtemperatur in Kelvin) ist stufenlos einstellbar.

#### Light color infinitely variable

The illuminant chromaticity (colour temperature in Kelvin) is infinitely variable.

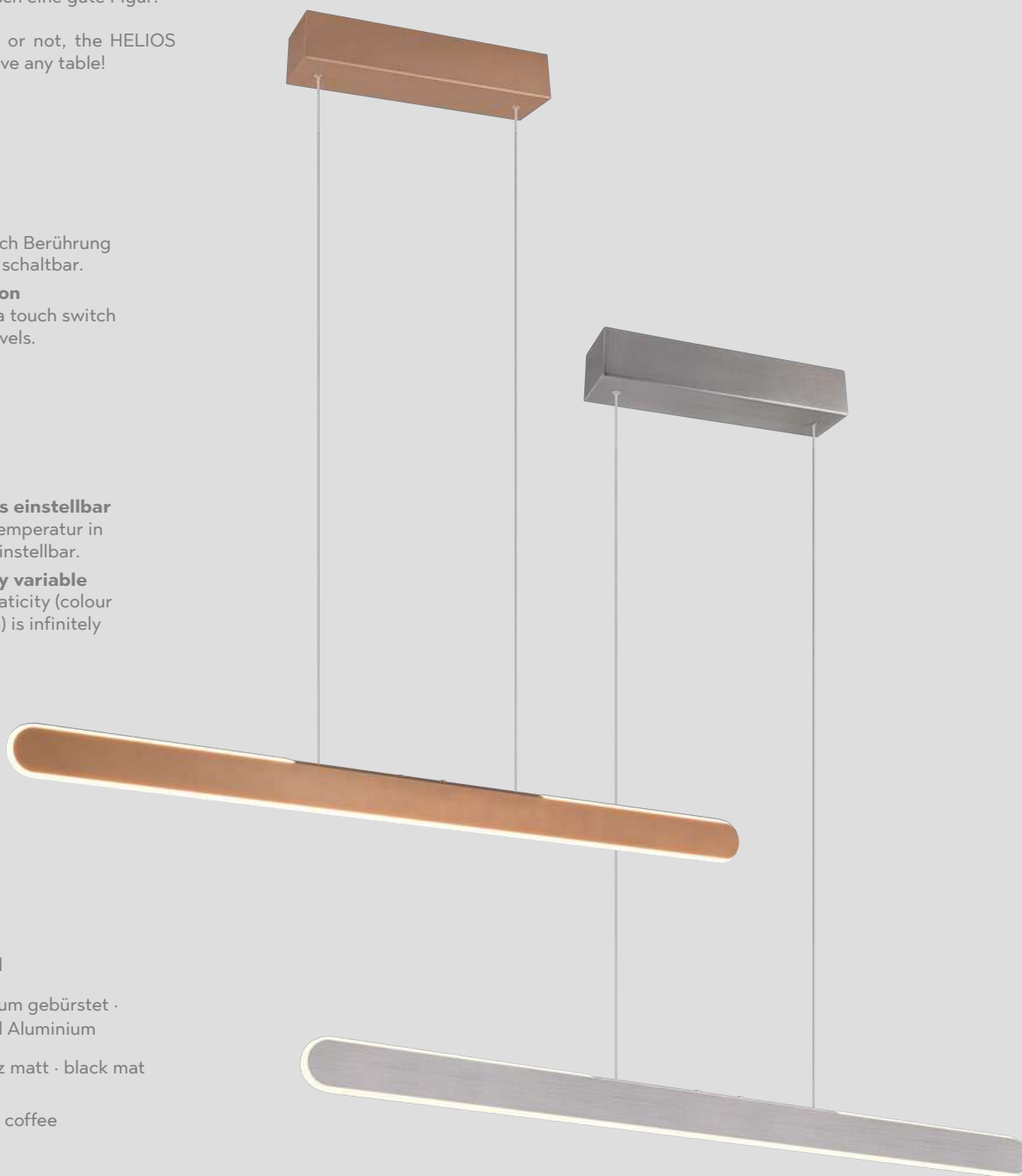

Metall · metal



**05** | Aluminium gebürstet · brushed Aluminium



**32** | Schwarz matt · black mat



**65** | Coffee · coffee

Pendelleuchte · Pendant

incl. SMD-LED

28 W / 3.300 Lumen

2.700 - 6.500 Kelvin

3433101**05**

3433101**32**

3433101**65**



IP20

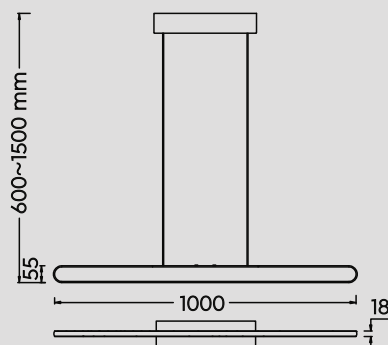



## LIFT ME

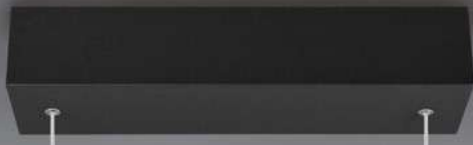

Innovative Höhenverstellung ohne Gegengewicht · Innovative height adjustment without counterweight

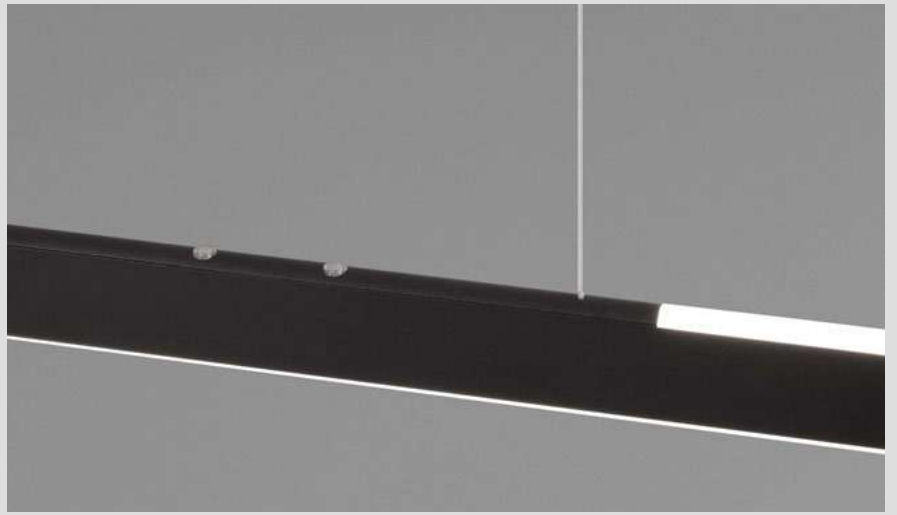

# HELIOS

Metall · metal



05 | Aluminium gebürstet · brushed Aluminium



32 | Schwarz matt · black mat



65 | Coffee · coffee

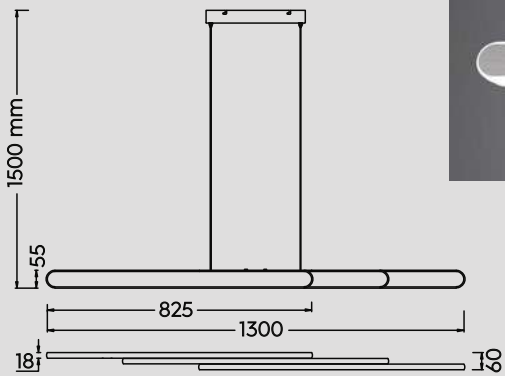

Pendelleuchte · Pendant

incl. SMD-LED

48 W / 5.800 Lumen

2.700 - 6.500 Kelvin

343310305

343310332

343310365

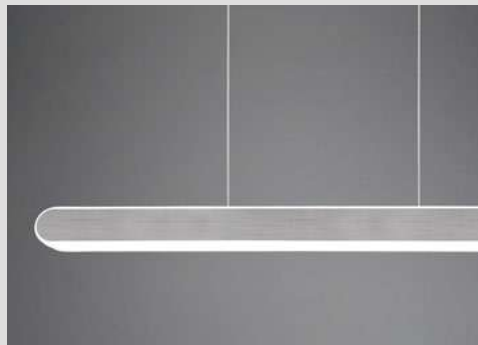

Ausziehbar 95 - 150 cm  
Extendible 95 - 150 cm



**Lichtfarbe stufenlos einstellbar**

Die Lichtfarbe (Farbtemperatur in Kelvin) ist stufenlos einstellbar.

**Light color infinitely variable**

The illuminant chromaticity (colour temperature in Kelvin) is infinitely variable.



**4 fach TOUCH**

Diese Leuchte ist durch Berührung in 4 Helligkeitsstufen schaltbar.

**4 level Touch function**

This light fitting has a touch switch for 4 light intensity levels.



# BELFAST

Die Besonderheit ist nicht nur das eleganten Design, sondern vor allem die indirekte Beleuchtung am Baldachin.

The special feature is not only the elegant design, but above all the indirect lighting on the canopy.



## SWITCH DIMMER

Helligkeit in 3 Stufen mit herkömmlichem Lichtschalter einstellbar.

Brightness adjustable in 4 levels with conventional light switch.

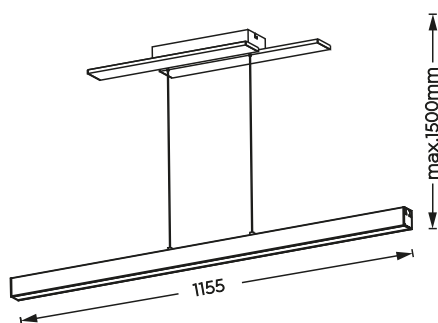

Pendelleuchte · Pendant

incl. SMD-LED  
45 W / 5.300 Lumen  
3.000 Kelvin

375510407

375510432

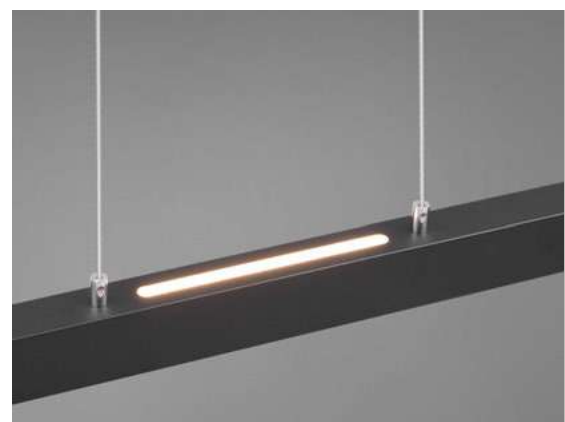

Gibt Licht nach oben und unten ·  
up and down lighting

Metall · metal

07 | Nickel matt · nickel mat

32 | Schwarz matt · black mat

# LACAL

Diese stilvolle Pendelleuchte bietet eine doppelte Lichtquelle, die sowohl nach oben als auch nach unten strahlt. Die höhenverstellbare Aufhängung ermöglicht es Ihnen, die Leuchte perfekt an die unterschiedlichen Bedürfnisse anzupassen.

This stylish pendant light offers a double light source that shines both upwards and downwards. The height-adjustable suspension allows you to adapt the light perfectly to different requirements.



Lichtfarbe einstellbar ·  
Adjustable light color



4 fach TOUCH ·  
4 level Touch function



Metall · metal



**07** | Nickel matt · nickel mat



**32** | Schwarz matt · black mat

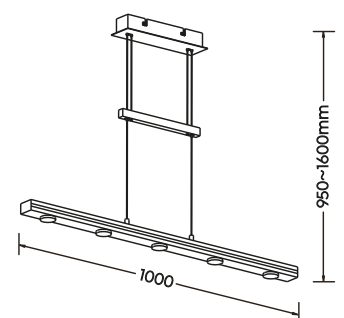

Pendelleuchte · Pendant

incl. 7 x SMD-LED  
4 W / 7 x 380 Lumen  
3.000 + 5.000 Kelvin

**379190707**

**379190732**



IP20

# FRANKLIN

Die FRANKLIN sticht besonders durch ihren interessanten Leuchtenkopf hervor, da dieser das Licht seitlich und nach unten abstrahlt.

The FRANKLIN stands out in particular due to its interesting luminaire head, which emits light sideways and downwards.



## SWITCH DIMMER

Helligkeit in 3 Stufen mit herkömmlichem Lichtschalter einstellbar.

Brightness adjustable in 4 levels with conventional light switch.

Metall · metal



**07** | Nickel matt · nickel mat



**42** | Anthrazit · anthracite

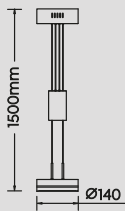
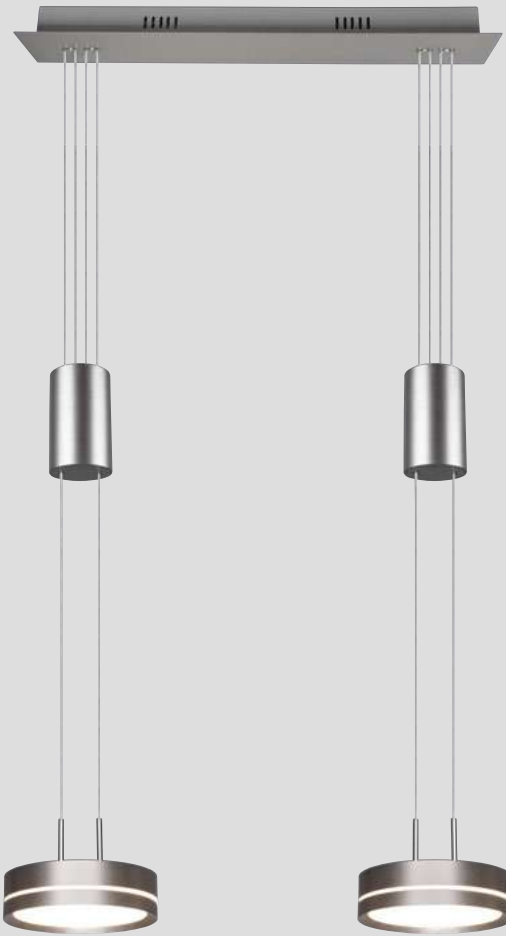

Pendelleuchte · Pendant

incl. SMD-LED  
9 W / 1.050 Lumen  
3.000 Kelvin

**326510107**  
**326510142**

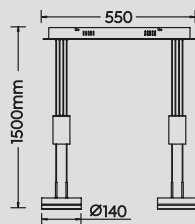

Pendelleuchte · Pendant

incl. 2 x SMD-LED  
9 W / 2 x 1.050 Lumen  
3.000 Kelvin

**326510207**  
**326510242**

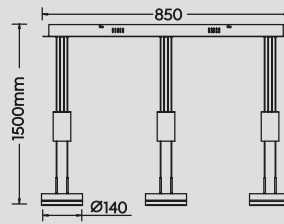

Pendelleuchte · Pendant

incl. 3 x SMD-LED  
9 W / 3 x 1.050 Lumen  
3.000 Kelvin

**326510307**  
**326510342**





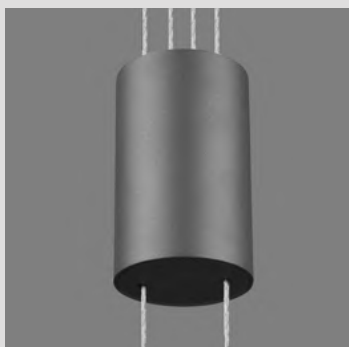
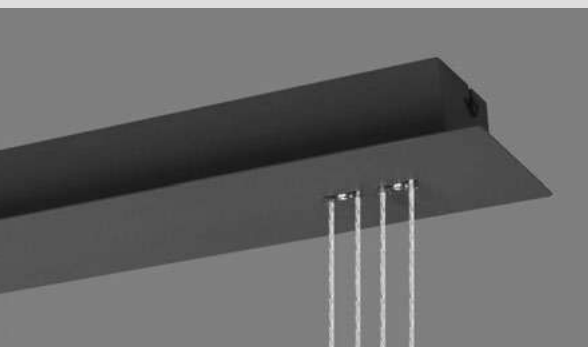

# FRANKLIN



04 | Altmessing · old brass



07 | Nickel matt · nickel mat



42 | Anthrazit · anthracite

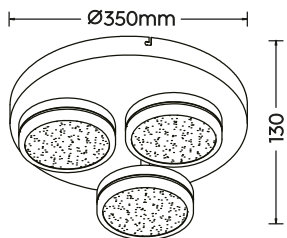

Deckenleuchte · Ceiling lamp  
incl. SMD-LED  
3 x 8,5 W / 3 x 1.000 Lumen  
3.000 Kelvin  
626510304  
626510307  
626510342

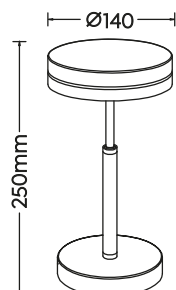

Tischleuchte · Table lamp  
incl. SMD-LED  
6 W / 700 Lumen  
3.000 Kelvin  
526510104  
526510107  
526510142

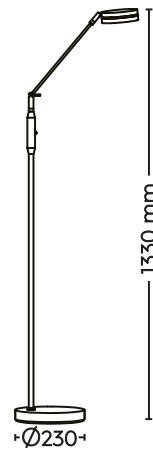

Stehleuchte · Floor lamp  
incl. SMD-LED  
6,5 W / 650 Lumen  
2.700 + 3.200 + 4.000 Kelvin  
426510104  
426510107  
426510142

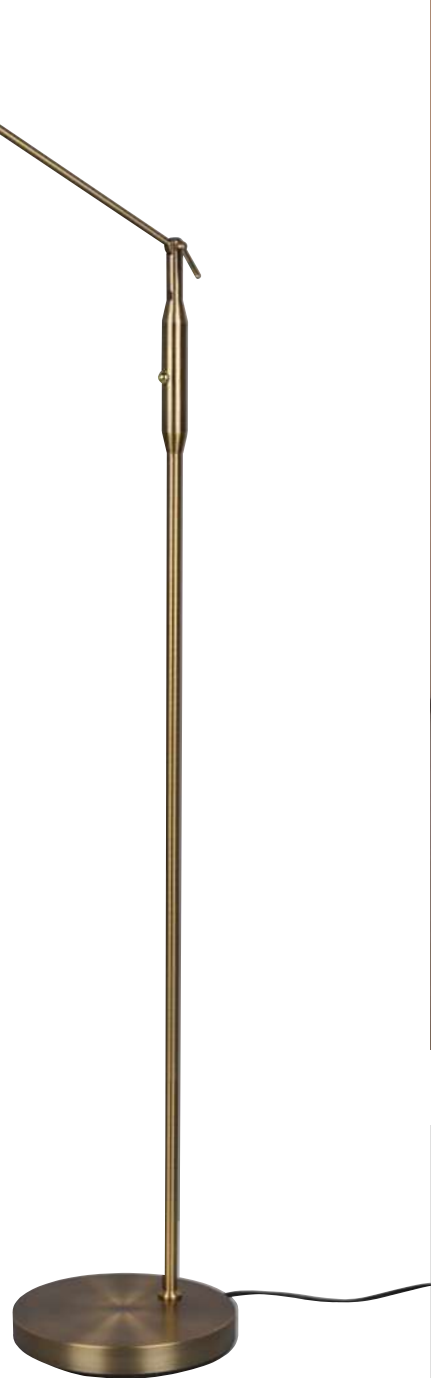

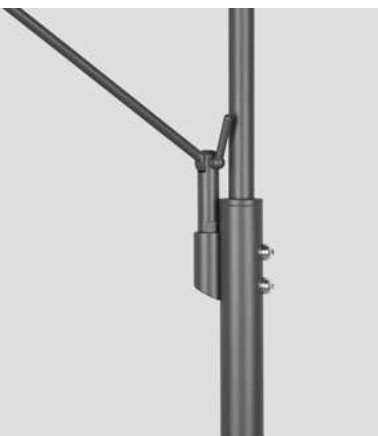

Lichtfarbe einstellbar ·  
Adjustable light color



Getrennt schaltbar ·  
Separately switchable



Memory Funktion ·  
Memory function

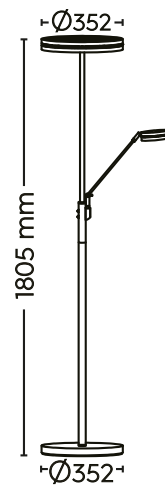

Stehleuchte · Floor lamp  
incl. SMD-LED  
35 W / 4.100 Lumen  
incl. SMD-LED  
6,5 W / 650 Lumen  
2.700 + 3.200 + 4.000 Kelvin  
**426510204**  
**426510207**  
**426510242**





#### SWITCH DIMMER

Helligkeit in 3 Stufen mit herkömmlichem Lichtschalter einstellbar.

Brightness adjustable in 4 levels with conventional light switch.

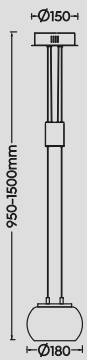

Pendelleuchte · Pendant

incl. 1 x SMD-LED  
8 W / 900 Lumen  
3.000 Kelvin

342010107

342010108

342010132

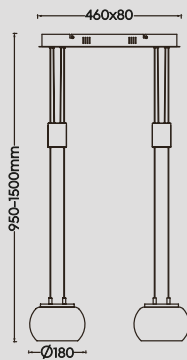

Pendelleuchte · Pendant

incl. 2 x SMD-LED  
8 W / 2 x 900 Lumen  
3.000 Kelvin

342010207

342010208

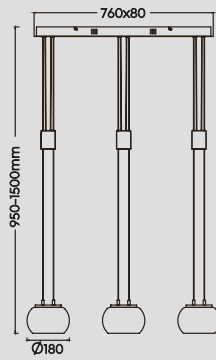

Pendelleuchte · Pendant

incl. 3 x SMD-LED  
8 W / 3 x 900 Lumen  
3.000 Kelvin

342010307

342010308

342010332



Metall, Glas weiß oder chrom bedampft · metal, glass white or chrome plated glass



07 | Nickel matt · nickel mat



08 | Messing matt · brass mat



32 | Schwarz matt · black mat

# MADISON

Die Formensprache der Pendelleuchten MADISON vereint modernes Design mit klassischer Eleganz.

The design language of the MADISON pendant lights combines modern design with classic elegance.



# MERTON

Die Pendelleuchte MERTON vereint modernes Design mit höchster Funktionalität. Ausgestattet mit der komfortablen Lift-Technologie, lässt sich die Leuchte mühelos in der Höhe verstellen und bietet so maximale Flexibilität.

The MERTON pendant light combines modern design with maximum functionality. Equipped with the convenient Lift-me technology, the height of the luminaire can be adjusted effortlessly, offering maximum flexibility.



## SWITCH DIMMER

Helligkeit in 3 Stufen mit herkömmlichem Lichtschalter einstellbar.

Brightness adjustable in 4 levels with conventional light switch.





**LIFT ME:**  
 Innovative Höhenverstellung ohne Gegengewicht ·  
 Innovative height adjustment without counterweight

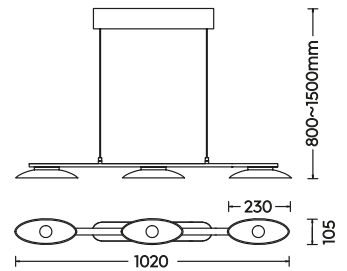

Pendelleuchte · Pendant  
 incl. 3 x SMD-LED  
 3 x 9 W / 3 x 950 Lumen  
 3.000 Kelvin  
**343610307**  
**343610308**

Metall, Glas Weiß · metal, glass white



**07** | Nickel matt · nickel mat



**08** | Messing matt · brass mat











Metall · metal

-  **17** | mehrfarbig · multicolor
-  **32** | Schwarz matt · black mat
-  **41** | Taupe · taupe
-  **44** | Beige · fawn
-  **65** | Coffee · coffee

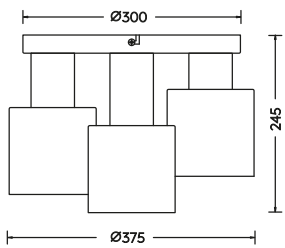

Deckenleuchte · Ceiling lamp  
excl. 3 x E27  
max. 40 W  
**619430317**

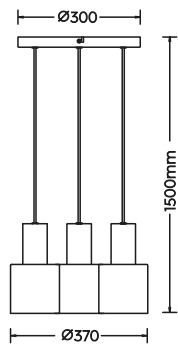

Pendelleuchte · Pendant  
excl. 3 x E27  
max. 40 W  
**319430317**

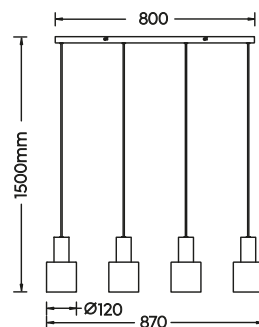

Pendelleuchte · Pendant  
excl. 4 x E27  
max. 40 W  
**319400417**

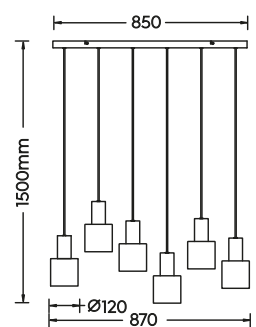

Pendelleuchte · Pendant  
excl. 6 x E27  
max. 40 W  
**319400617**



# AGUDO

AGUDO besticht durch seine einzigartige Farbpalette, die an verschiedene Kaffeespezialitäten erinnert: Latte Macchiato, Cappuccino, Café au Lait und Espresso.

AGUDO impresses with its unique colour palette, which is reminiscent of various coffee specialities: latte macchiato, cappuccino, café au lait and espresso.

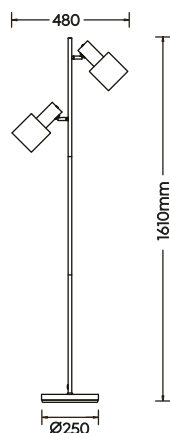
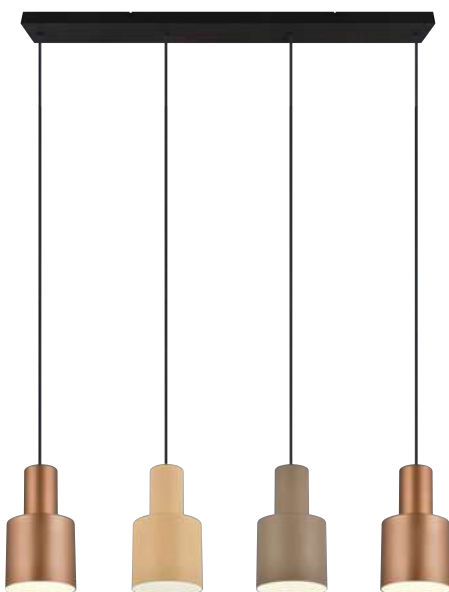

Stehleuchte · Floor lamp  
 excl. 2 x E27  
 max. 10 W  
 419400217 **NEW**  
 419400232 **NEW**



Pendelleuchte · Pendant  
 excl. 1 x E27  
 max. 10 W  
 319400132 **NEW**  
 319400141 **NEW**  
 319400144 **NEW**  
 319400165 **NEW**



# STREAM NEW

Moderne spiralförmige Cut-Outs erzeugen faszinierende Lichteffekte und die verschiedenen Farbkombinationen bieten ausreichend Gestaltungsmöglichkeiten.

Modern spiral cut-outs create fascinating lighting effects and the various colour combinations offer plenty of design options.

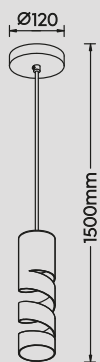
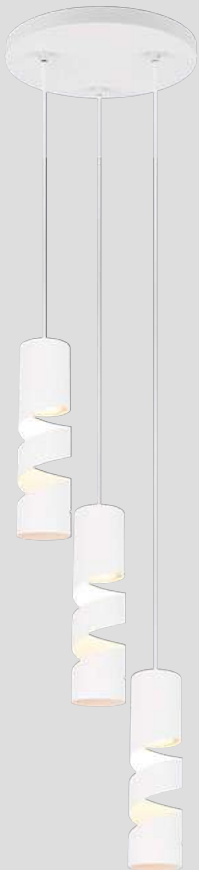

Pendelleuchte · Pendant

excl. 1 x GU10  
max. 10 W

364000131  
364000132  
364000165

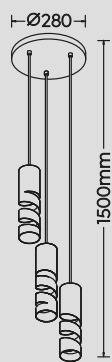

Pendelleuchte · Pendant

excl. 3 x GU10  
max. 10 W

364030317  
364030331  
364030332

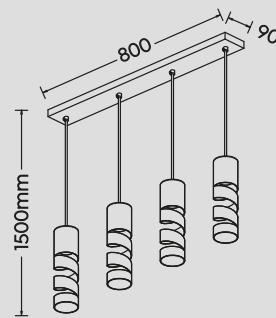

Pendelleuchte · Pendant

excl. 4 x GU10  
max. 10 W

364000417  
364000431  
364000432



Metall · metal

 17 | mehrfarbig · multicolor

 31 | Weiß matt · white mat

 32 | Schwarz matt · black mat

 65 | Coffee · coffee

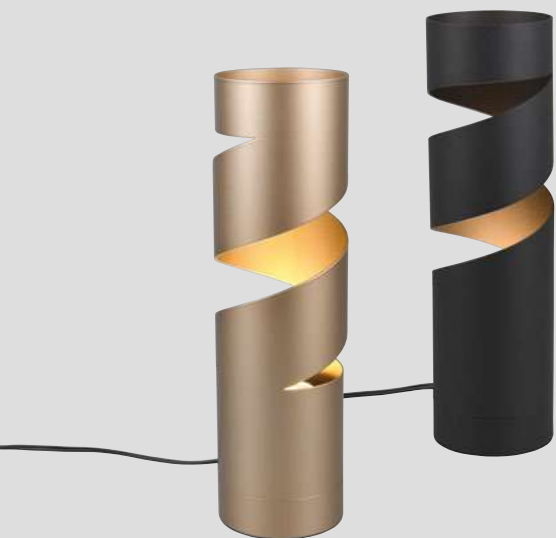

Tischleuchte · Table lamp

excl. 1 x GU10  
max. 10 W

564000131  
564000132  
564000165

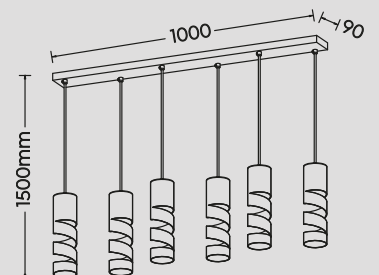

Pendelleuchte · Pendant

excl. 6 x GU10  
max. 10 W

364000617  
364000631  
364000632



# MARLEY

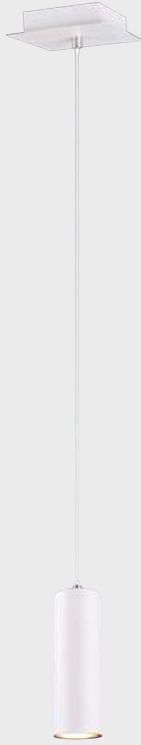
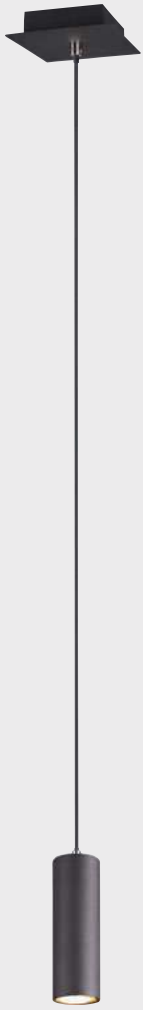

Seite / Page 476



Seite / Page 410

Weitere Produkte der Serie MARLEY · Further products in the MARLEY series



Pendelleuchte · Pendant

excl. 1 x GU10  
max. 35 W

312400101  
312400107  
312400132

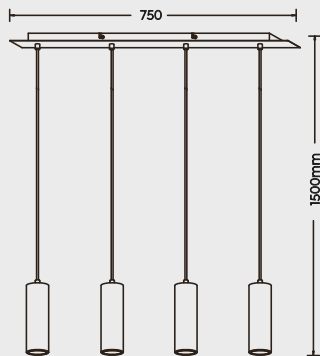

Pendelleuchte · Pendant

excl. 4 x GU10  
max. 35 W

312400401  
312400407  
312400432



- Metall · metal
-  01 | Weiß · white
-  07 | Nickel matt · nickel mat
-  32 | Schwarz matt · black mat



Metall · metal



32 | Schwarz matt · black mat

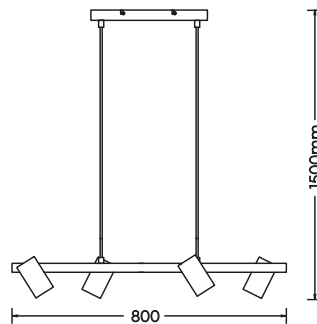
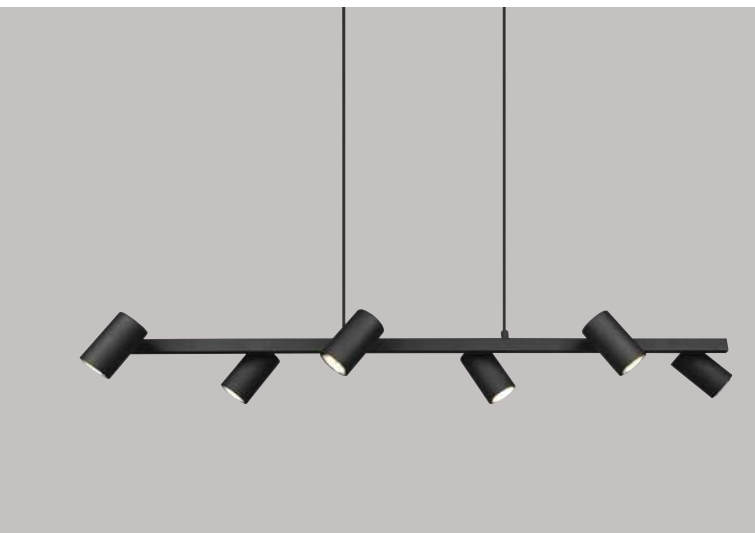

Pendelleuchte · Pendant  
 excl. 4 x GU10  
 max. 35 W  
 302400432

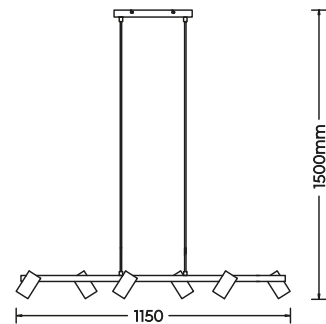

Pendelleuchte · Pendant  
 excl. 6 x GU10  
 max. 35 W  
 302400632



# MARLEY

Die Leuchtsérie MARLEY ist ein echter Allrounder. Die klaren Linien und das schlichte Design machen diese Leuchten zu einem zeitlosen Begleiter, der nie aus der Mode kommt.

The MARLEY luminaire series is a real all-rounder. The clear lines and simple design make these lights a timeless companion that never goes out of fashion.

Metall · metal



80 | Schwarz-Gold · black-gold



Seite / Page 410



Seite / Page 476

Weitere Produkte der Serie MARLEY · Further products in the MARLEY series

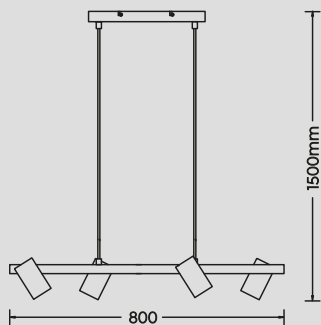

Pendelleuchte · Pendant  
excl. 4 x GU10  
max. 35 W  
**302400480**

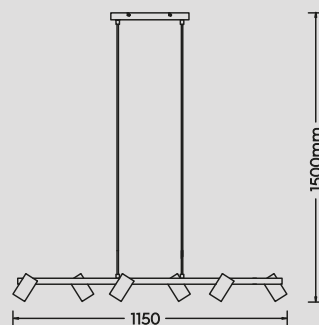

Pendelleuchte · Pendant  
excl. 6 x GU10  
max. 35 W  
**302400680**



Empfohlen:  
recommended:

LED GU10  
4,5 W / 345 Lumen  
3.000 Kelvin  
**956-5936**







Metall, Holz · metal, wood



32 | Schwarz matt · black mat

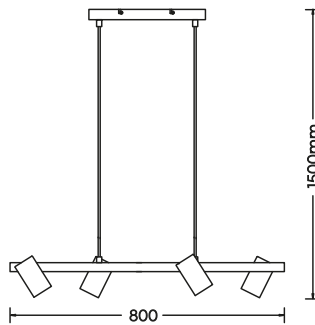

Pendelleuchte · Pendant  
 excl. 4 x GU10  
 max. 35 W  
**312490432**

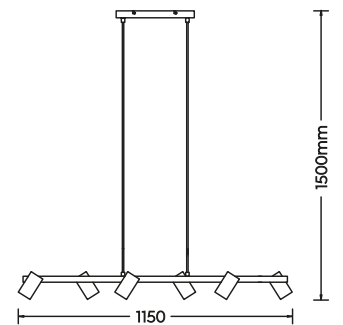

Pendelleuchte · Pendant  
 excl. 6 x GU10  
 max. 35 W  
**312490632**



# CHIRON

Die klassische Formgebung, kombiniert mit der schimmernden Farbgestaltung, lassen den Allrounder zu einem wahren Highlight werden.

The classic design combined with the shimmering colour scheme make this all-rounder a real highlight.



Aluminium · aluminium



08 | Messing matt · brass mat

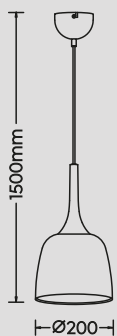

Pendelleuchte · Pendant

excl. 1 x E27  
max. 40 W

310800108

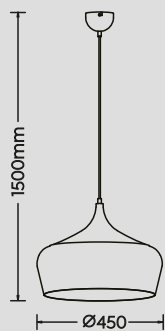

Pendelleuchte · Pendant

excl. 1 x E27  
max. 40 W

310890108

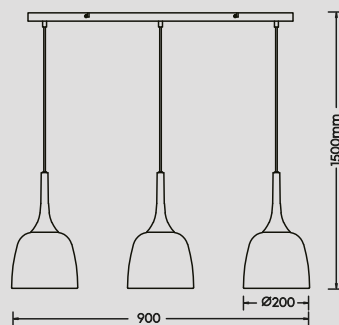

Pendelleuchte · Pendant

excl. 3 x E27  
max. 40 W

310800308





Metall, innen goldfarbig ·  
metal, gold colored inside



32 | Schwarz matt · black mat

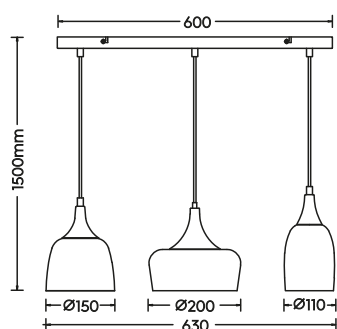

Pendelleuchte · Pendant  
excl. 3 x E14  
max. 25 W  
310500332

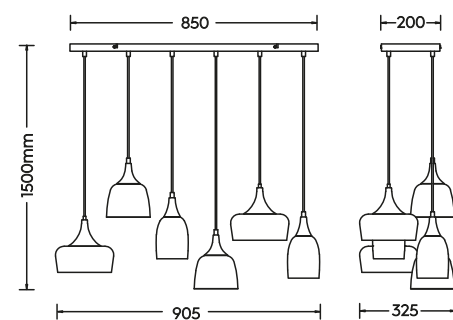

Pendelleuchte · Pendant  
excl. 6 x E14  
max. 25 W  
310500632



# ONYX

Diese Pendelleuchten vereinen modernes Design mit faszinierenden Lichteffekten. Der stilvolle Metallschirm ist mit rautenförmigen Lichtaustritten versehen, die das Licht auf einzigartige Weise brechen und zauberhafte Muster an Wände und Decken projizieren.

These pendant lights combine modern design with fascinating lighting effects. The stylish metal shade has diamond-shaped light outlets that refract the light in a unique way and project enchanting patterns onto walls and ceilings.

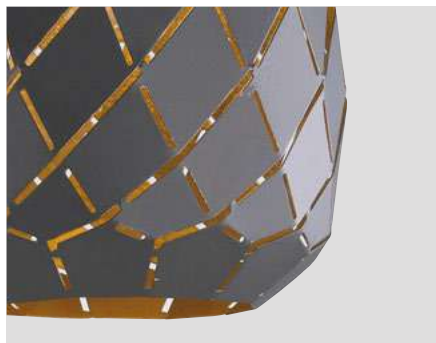

Metall, innen goldfarbig ·  
metal, gold colored inside

42 | Anthrazit · anthracite

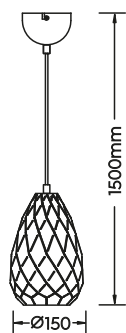

Pendelleuchte · Pendant  
excl. 1 x E27  
max. 42 W  
301300142

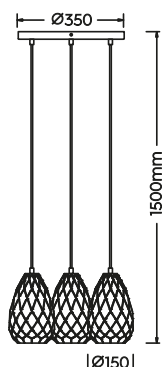

Pendelleuchte · Pendant  
excl. 3 x E27  
max. 42 W  
301300342

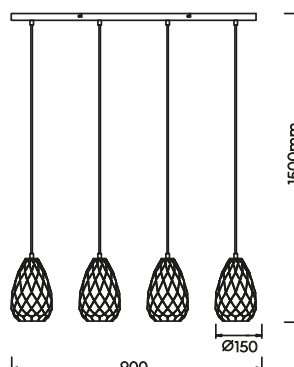

Pendelleuchte · Pendant  
excl. 4 x E27  
max. 42 W  
301300442









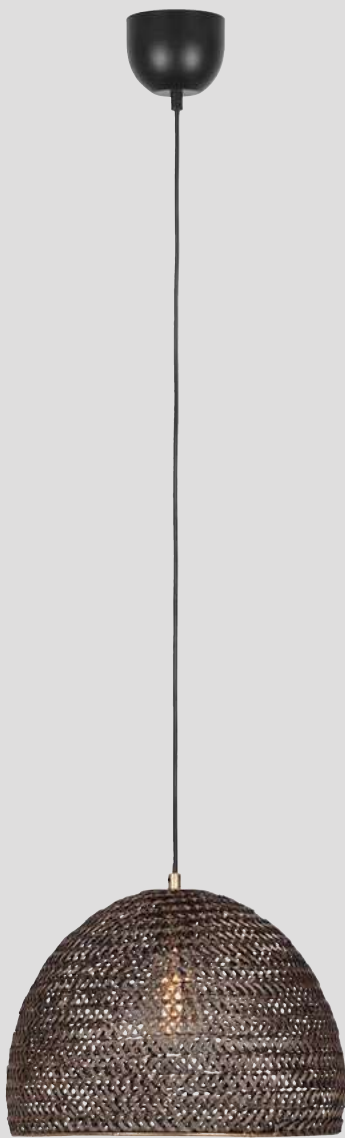

Metall · metal



04 | Altmessing · old brass



## KAMARA NEW

KAMARA wird aus einem filigranen Drahtgeflecht gefertigt, das in kunstvoller Handarbeit zu außergewöhnlichen Formen gestaltet wird. Dieses Material ist nicht nur widerstandsfähig und haltbar, sondern auch äußerst dekorativ. Die offene Struktur des Geflechts erzeugt ein faszinierendes Zusammenspiel von Licht und Schatten.

KAMARA is made from a filigree wire mesh that is skilfully handcrafted into unusual shapes. This material is not only resistant and durable, but also extremely decorative. The open structure of the mesh creates a fascinating interplay of light and shadow.

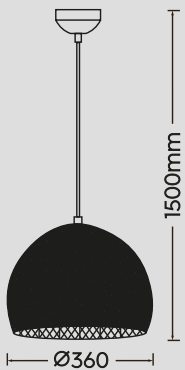

Pendelleuchte · Pendant

excl. 1 x E27  
max. 10 W

365290104



IP20



# ZIVA NEW

Die Leuchten bestehen aus feinem Drahtgeflecht, das in kunstvoller Handarbeit zu einzigartigen Formen verarbeitet wird. Das Material ist nicht nur robust und langlebig, sondern auch ein echter Hingucker. Die offene Struktur des Drahtgeflechts sorgt für ein faszinierendes Lichtspiel, das jedem Raum eine besondere Atmosphäre verleiht.

The lights are made of fine wire mesh, which is skilfully handcrafted into unique shapes. The material is not only robust and durable, but also a real eye-catcher. The open structure of the wire mesh creates a fascinating play of light that lends any room a special atmosphere.

Metall · metal



04 | Altmessing · old brass



Empfohlen:  
recommended:

LED E27  
7 W / 500 Lumen  
1.800 Kelvin

**987-4813**

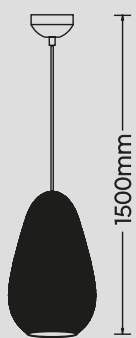

∅230

Pendelleuchte · Pendant

excl. 1 x E27  
max. 10 W

**365300104**

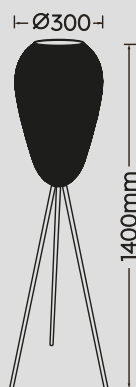

∅430

Stehleuchte · Floor lamp

excl. 1 x E27  
max. 10 W

**465300104**



# SORAYA NEW

Die Pendelleuchten aus feinem Metallgeflecht wirken kunstvoll und dekorativ und verleihen jedem Raum ein besonderes Flair.

The pendant lights made of fine metal mesh have an artistic and decorative effect and add a special flair to any room.



Empfohlen:  
recommended:

LED E27  
7 W / 500 Lumen  
1.800 Kelvin  
**987-4813**



Metall · metal

● **04** | Altmessing · old brass

● **32** | Schwarz matt · black mat

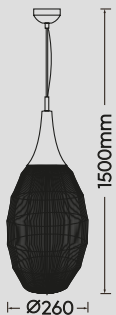

Pendelleuchte · Pendant

excl. 1 x E27  
max. 10 W

**365420104**  
**365420132**

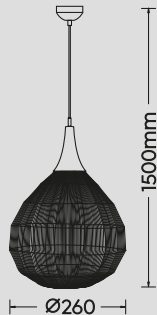

Pendelleuchte · Pendant

excl. 1 x E27  
max. 10 W

**365430104**  
**365430132**



Pendelleuchte · Pendant

excl. 1 x E27  
max. 10 W

**365440104**  
**365440132**

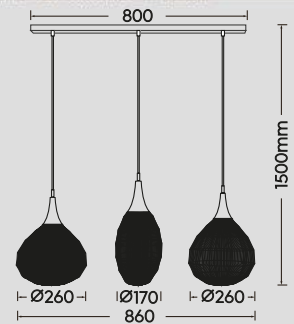

Pendelleuchte · Pendant

excl. 3 x E27  
max. 10 W

**365400304**  
**365400332**





# GILA

Gefertigt aus robustem Metall, bieten diese Leuchten nicht nur eine beeindruckende Optik, sondern auch Langlebigkeit und Stabilität. Sie sind sowohl in modernen als auch in klassischen Interieurs ein stilvolles Highlight.

Made from robust metal, these lights not only offer an impressive look, but also durability and stability. They are a stylish highlight in both modern and classic interiors.

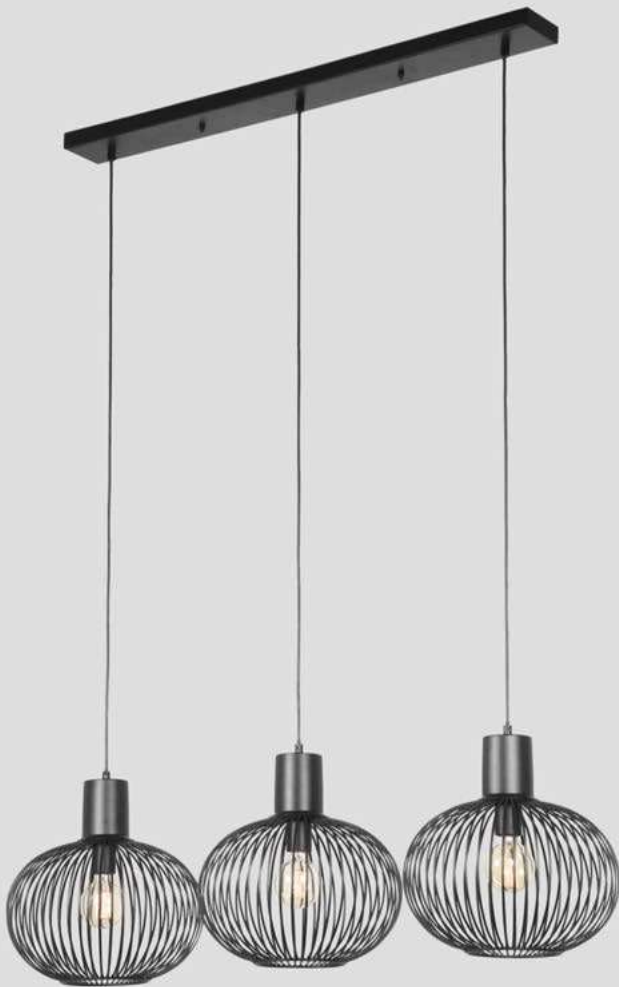

Metall · metal

32 | Schwarz matt · black mat

66 | Sand · sand

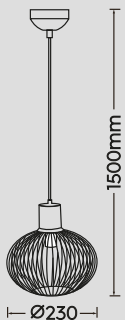

Pendelleuchte · Pendant

excl. 1 x E27  
max. 10 W

365700132  
365700166

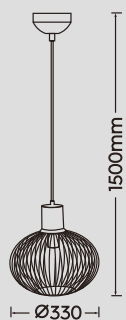

Pendelleuchte · Pendant

excl. 1 x E27  
max. 10 W

365790132  
365790166

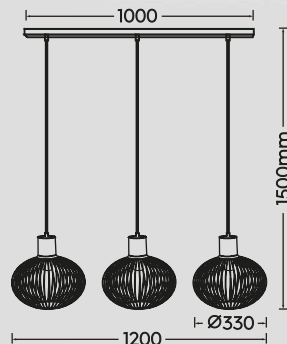

Pendelleuchte · Pendant

excl. 3 x E27  
max. 10 W

365700332  
365700366



Empfohlen:  
recommended:

Filament LED E27  
4 W / 470 Lumen  
3.000 Kelvin

987-479

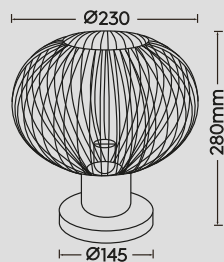

Tischleuchte · Table lamp  
 excl. 1 x E27  
 max. 10 W  
**565700132**  
**565700166**

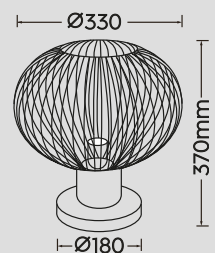

Tischleuchte · Table lamp  
 excl. 1 x E27  
 max. 10 W  
**565790132**  
**565790166**



# DIALLO

Metall · metal

32 | Schwarz matt · black mat

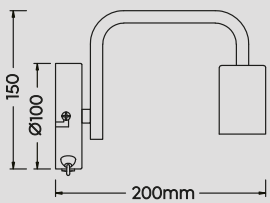
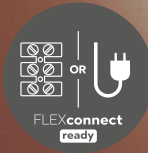

Wandleuchte · Wall lamp  
excl. 1 x E27  
max. 42 W  
208070132

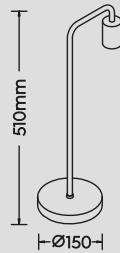

Tischleuchte · Table lamp  
excl. 1 x E27  
max. 42 W  
508000132

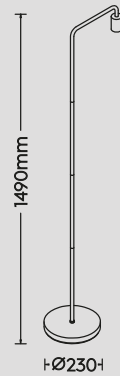

Stehleuchte · Floor lamp  
excl. 1 x E27  
max. 42 W  
408000132



Empfohlen:  
recommended:

Filament LED E27  
7 W / 806 Lumen  
2.700 Kelvin  
**988-600**

# TAMIL

Metall · metal



08 | Messing matt · brass mat

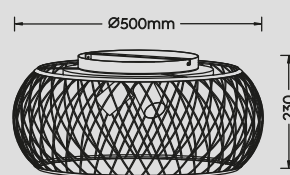

Deckenleuchte · Ceiling lamp  
excl. 3 x E27  
max. 40 W  
611100308

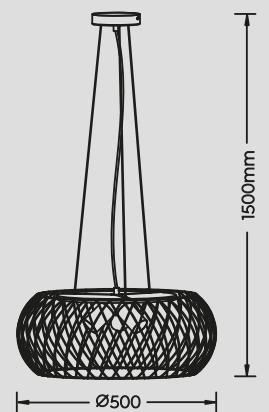

Pendelleuchte · Pendant  
excl. 3 x E27  
max. 40 W  
311100308



# CROSS

Unkonventionell, kreativ und designorientiert - Minimalistische Leuchten wie die Serie CROSS setzen spannende Akzente und rücken Räume ins rechte Licht.

Unconventional, creative and design-orientated - minimalist luminaires such as the CROSS range set exciting accents and put rooms in the right light.



Empfohlen:  
recommended:

LED E27  
6 W / 660 Lumen  
2.700 Kelvin  
**988-679**



Metall · metal



32 | Schwarz matt / goldfarbig · black mat / gold

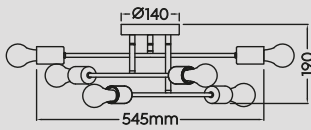

Deckenleuchte · Ceiling lamp  
excl. 6 x E27  
max. 40 W  
**606700632**

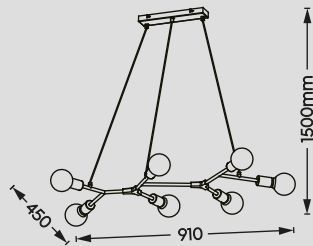

Pendelleuchte · Pendant  
excl. 7 x E27  
max. 28 W  
**306700732**

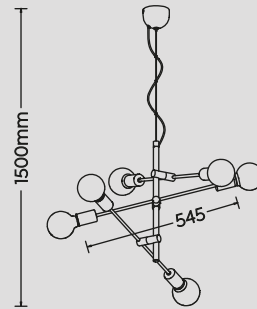

Pendelleuchte · Pendant  
excl. 6 x E27  
max. 28 W  
**306700632**

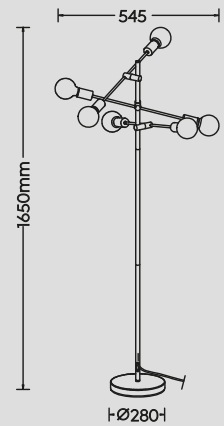

Stehleuchte · Floor lamp  
excl. 6 x E27  
max. 28 W  
**406700632**







# ROPE

Die Seil-Aufhängung mit dekorativem Knotendetail verleiht Räumen einen Hauch von rustikalem Charme.

The rope suspension with decorative knot detail gives rooms a touch of rustic charm.



Empfohlen:  
recommended:

LED E27  
6 W / 660 Lumen  
2.700 Kelvin  
**988-679**

Metall · metal

**04** | Altmessing · old brass

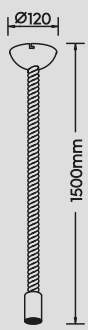

Pendelleuchte · Pendant  
excl. 1 x E27  
max. 60 W  
**310100104**

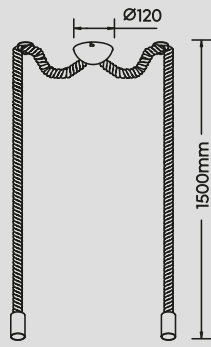

Pendelleuchte · Pendant  
excl. 2 x E27  
max. 60 W  
**310100204**





# CORD

Metall, Stoffkabel · metal, fabric sheathed cable



62 | Kupfer antik · antique copper

Empfohlen:  
recommended:

LED E27  
4 W / 320 Lumen  
2.700 Kelvin



901-479



902-479



904-479

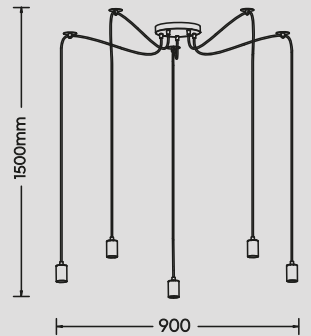

Pendelleuchte · Pendant  
excl. 5 x E27  
max. 60 W  
310100562



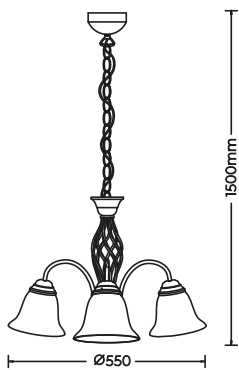

Pendelleuchte · Pendant  
excl. 3 x E14  
max. 40 W  
**101000324**

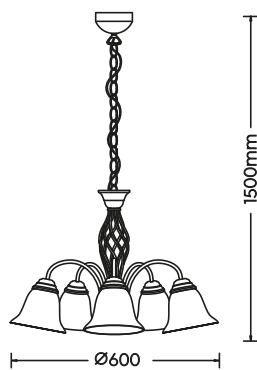

Pendelleuchte · Pendant  
excl. 5 x E14  
max. 40 W  
**101000524**

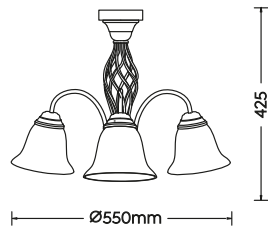

Deckenleuchte · Ceiling lamp  
excl. 3 x E14  
max. 40 W  
**601000324**

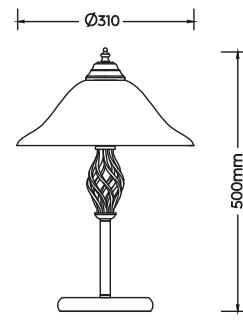

Tischleuchte · Table lamp  
excl. 2 x E14  
max. 40 W  
**501000224**



# RUSTICA

Wie der Name vermuten lässt, eine rustikale Serie, die dem Landhausstil treu bleibt.

As the name suggests, a rustic range that remains true to the country house style.

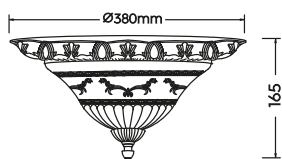

Deckenleuchte · Ceiling lamp  
excl. 2 x E27  
max. 60 W  
**6102021-24**

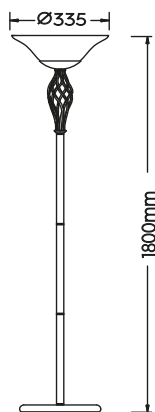

Stehleuchte · Floor lamp  
excl. 2 x E27  
max. 60 W  
**401000224**

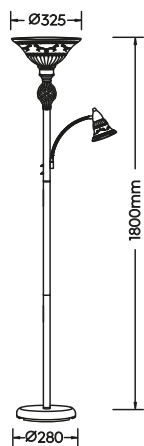

Stehleuchte · Floor lamp  
excl. 1 x E27, max. 100 W  
excl. 1 x E14, max. 40 W  
**4602021-24**



Metall, Glas matt · metal, mat glass

**24** | rostfarbig · rusty

# TRADITIO

Die Leuchtenserie TRADITIO besticht durch Charme und Eleganz. Mit filigranen Verzierungen und geschwungenen Formen bringt sie eine zeitlose Eleganz in jeden Raum.

The TRADITIO luminaire series impresses with its charm and elegance. With delicate decorations and curved shapes, it brings a timeless elegance to any room.



Metall, Glas alabasterfarbig ·  
metal, alabaster-coloured glass

28 | rostfarbig antik · antique rust

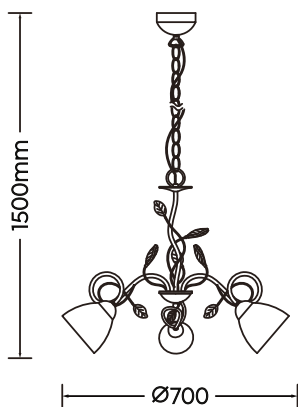

Pendelleuchte · Pendant  
excl. 3 x E14  
max. 40 W  
110700328

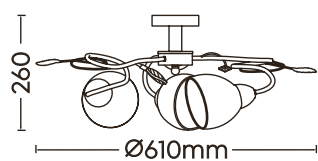

Deckenleuchte · Ceiling lamp  
excl. 3 x E27  
max. 40 W  
600700328

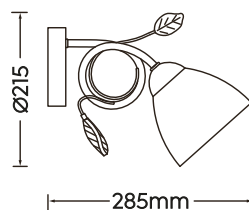

Wandleuchte · Wall lamp  
excl. 1 x E14  
max. 40 W  
200700128



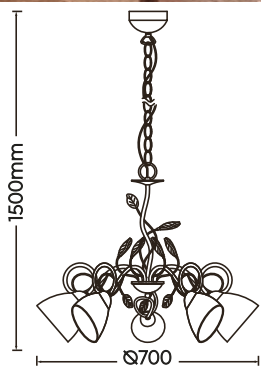

Pendelleuchte · Pendant  
 excl. 5 x E14  
 max. 40 W  
 110700528

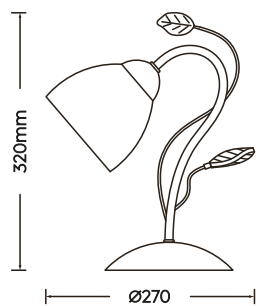

Tischleuchte · Table lamp  
 excl. 1 x E14  
 max. 40 W  
 500700128









# FACETTE NEW

Ob als Pendelleuchte über dem Esstisch oder als dekorative Tischleuchte auf dem Sideboard – die verschiedenen Farbakzente verleihen jedem Raum eine persönliche Note und schaffen eine einzigartige Atmosphäre.

Whether as a pendant light above the dining table or as a decorative table lamp on the sideboard - the different colour accents give every room a personal touch and create a unique atmosphere.



Metall Schwarz matt, Glas · metal black mat, glass

- 13** | Amber · amber
- 15** | Grün · green
- 17** | mehrfarbig · multicolor
- 54** | rauchfarbig · smoke



Pendelleuchte · Pendant  
excl. 1 x E27  
max. 25 W  
**364200154**

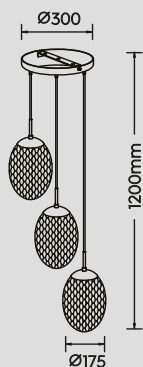

Pendelleuchte · Pendant  
excl. 3 x E27  
max. 25 W  
**364230317**

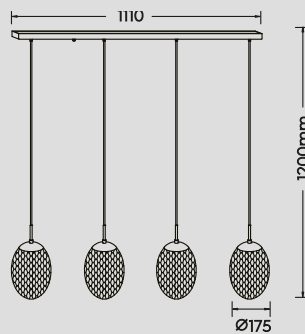

Pendelleuchte · Pendant  
excl. 4 x E27  
max. 25 W  
**364200417**



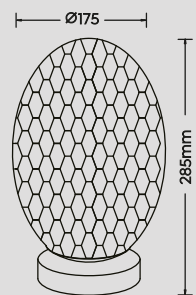

Tischleuchte · Table lamp

excl. 1 x E27  
max. 25 W

564200113

564200115

564200154



IP20

# DIVA NEW

Die Kombination aus klassischem Design und edlem Glas macht diese Serie zur idealen Wahl für alle, die Wert auf eine zeitlose und stilvolle und Beleuchtung legen.

The combination of classic design and elegant glass makes this series the ideal choice for anyone who values timeless and stylish lighting.

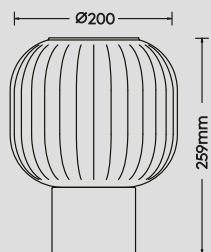

Tischleuchte · Table lamp

excl. 1 x E27  
max. 40 W

519800108

519800132

08 | Messing matt · brass mat

32 | Schwarz matt · black mat



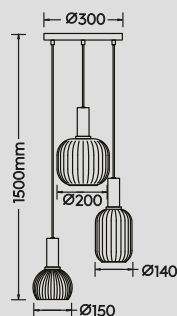

Pendelleuchte · Pendant  
 excl. 3 x E27  
 max. 10 W  
**319830308**  
**319830332**

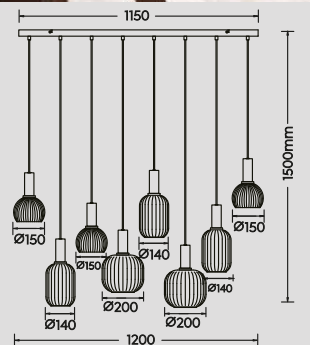

Pendelleuchte · Pendant  
 excl. 8 x E27  
 max. 10 W  
**319800808**  
**319800832**



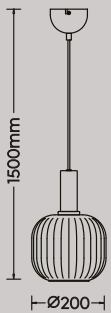
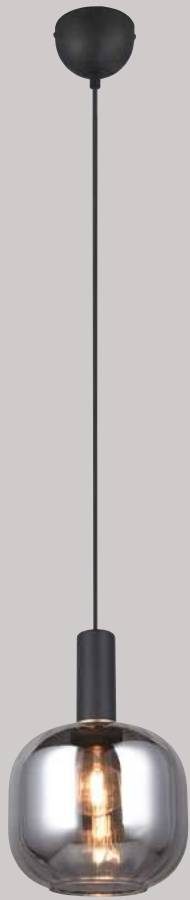

Pendelleuchte · Pendant

excl. 1 x E27  
max. 10 W

319800108  
319800132

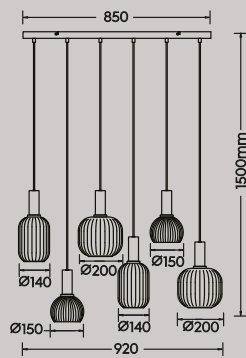

Pendelleuchte · Pendant

excl. 6 x E27  
max. 10 W

319800608  
319800632



Metall, Glas Weiß oder chrom bedampft ·  
metal, glass white or chrome plated glass

 **08** | Messing matt · brass mat

 **32** | Schwarz matt · black mat

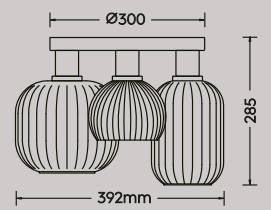

Deckenleuchte · Ceiling lamp

excl. 3 x E27

max. 10 W

619800308

619800332



# MATARO NEW

Die Verwendung von chrom bedampftem Rauchglas gewährleistet eine blendfreie Lichtverteilung, während die Kombination der mit GU10 Leuchtmitteln bestückten Metallpendeln für eine harmonische und stilvolle Optik sorgt.

The use of chrome-plated smoked glass ensures glare-free light distribution, while the combination of metal pendants fitted with GU10 light sources creates a harmonious and stylish look.

Metall, Glas chrom bedampft · metal, chrome plated glass

32 | Schwarz matt · black mat

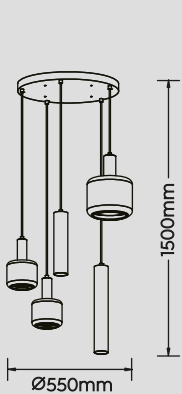

Pendelleuchte · Pendant  
excl. 1 x E27, max. 10 W  
excl. 2 x E14, max. 10 W  
excl. 2 x GU10, max. 25 W  
**364130532**

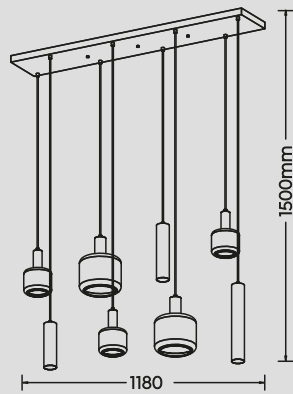

Pendelleuchte · Pendant  
excl. 2 x E27, max. 10 W  
excl. 3 x E14, max. 10 W  
excl. 3 x GU10, max. 25 W  
**364100832**



Tischleuchte · Table lamp  
excl. 1 x E14  
max. 10 W  
**564100132**







# CLAYTON



Zeitlos, schlicht und dennoch charakteristisch. Die moderne Pendelleuchte CLAYTON zieht durch die Kombination aus edlen Glasschirmen und dunklem Metall alle Blicke auf sich.

Timeless, simple and yet characteristic. The modern CLAYTON pendant light attracts everyone's attention with its combination of elegant glass shades and dark metal.

Metall, Glas chrom bedampft ·  
metal, chrome plated glass



32 | Schwarz matt · black mat

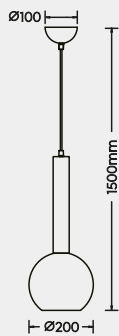

Pendelleuchte · Pendant  
 excl. 1 x E27  
 max. 28 W  
**310300132**

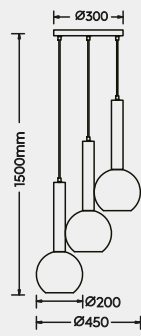

Pendelleuchte · Pendant  
 excl. 3 x E27  
 max. 28 W  
**310390332**

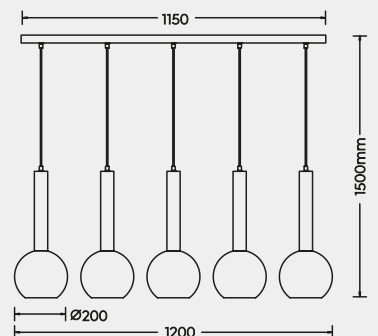

Pendelleuchte · Pendant  
 excl. 5 x E27  
 max. 28 W  
**310300532**



# LUMINA

Die Leuchten bestechen durch ihr klassisches und ansprechendes Design. Die harmonische Komposition aus verschieden geformten Glasschirmen schafft eine einzigartige Lichtatmosphäre.

The lights impress with their classic and appealing design. The harmonious composition of differently shaped glass shades creates a unique lighting atmosphere.

Metall, Glas amber oder chrom bedampft · metal, glass amber or chrome plated

 13 | Amber · amber

 32 | Schwarz matt · black mat

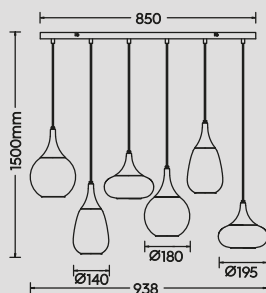

Pendelleuchte · Pendant  
excl. 6 x E14  
max. 40 W  
**317000613 NEW**  
**317000632**

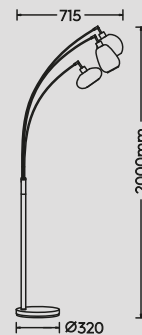

Stehleuchte · Floor lamp  
excl. 3 x E14  
max. 10 W  
**417000313 NEW**  
**417000332**



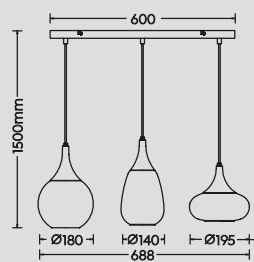

Pendelleuchte · Pendant  
 excl. 3 x E14  
 max. 40 W  
**317000313 NEW**  
**317000332**

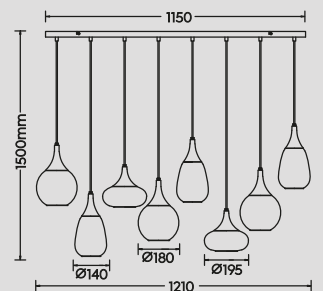

Pendelleuchte · Pendant  
 excl. 8 x E14  
 max. 40 W  
**317000813 NEW**  
**317000832**





Metall, Glas chrom bedampft ·  
metal, chrome plated glass

32 | Schwarz matt · black mat

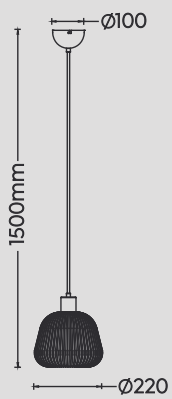

Pendelleuchte · Pendant  
excl. 1 x E27  
max. 25 W  
362800132



Pendelleuchte · Pendant  
excl. 3 x E27  
max. 25 W  
362830332

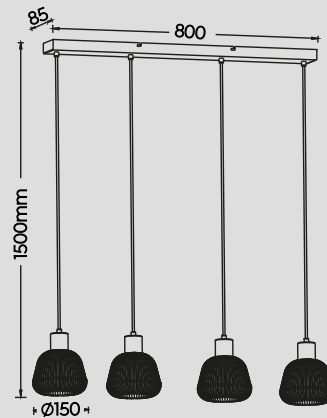

Pendelleuchte · Pendant  
excl. 4 x E27  
max. 25 W  
362800432



# TARIFA NEW

Das rauchfarbene Riffelglas verleiht den Leuchten eine besondere Tiefe und sorgt für eine angenehme Lichtverteilung, die jedem Raum eine warme und einladende Atmosphäre verleiht.

The smoke-coloured ribbed glass gives the lights a special depth and ensures a pleasant light distribution that lends every room a warm and inviting atmosphere.



# TARIFA NEW



Metall, Glas chrom bedampft ·  
metal, chrome plated glass

● 32 | Schwarz matt · black mat

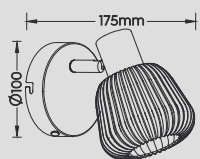
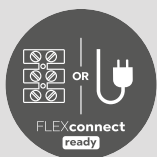

Strahler · Spot  
excl. 1 x E14  
max. 10 W  
862800132

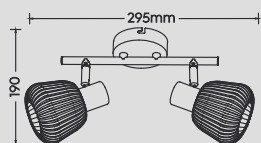

Strahler · Spot  
excl. 2 x E14  
max. 10 W  
862800232

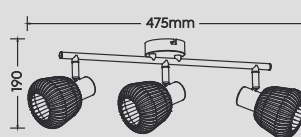

Strahler · Spot  
excl. 3 x E14  
max. 10 W  
862800332

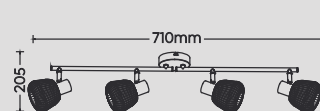

Strahler · Spot  
excl. 4 x E14  
max. 10 W  
862800432





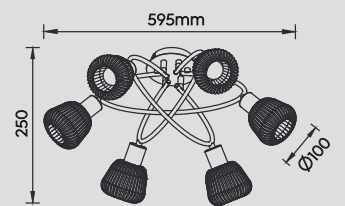

Deckenleuchte · Ceiling lamp

Excl. 6 x E14

max. 10 W

662800632



IP20

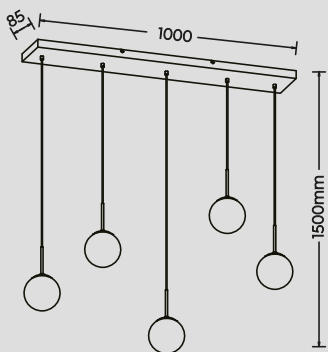

Pendelleuchte · Pendant  
excl. 5 x E14  
max. 28 W  
308500542



# BALINI

Die runden, rauchfarbigen Gläser machen BALINI zur idealen Ergänzung für moderne Einrichtungsstile.

The round, smoke-coloured glasses make BALINI the ideal addition to modern furnishing styles.

Metall, Rauchglas · metal, smoked glass

42 | Anthrazit · anthracite

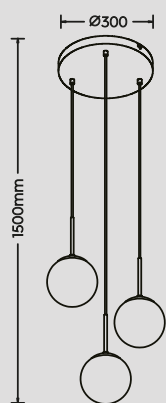

Pendelleuchte · Pendant  
excl. 3 x E14  
max. 28 W  
308590342

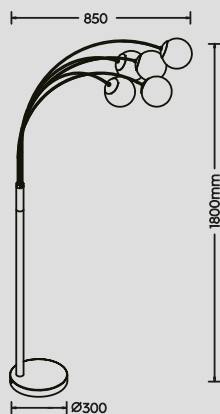

Stehleuchte · Floor lamp  
excl. 5 x E14  
max. 28 W  
408500542



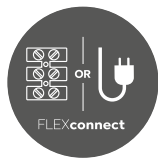

Diese Wandleuchte ist sowohl für den Festanschluss, als auch für den Betrieb mit Steckerzuleitung geeignet.

This wall light is suitable both for a fixed power connection, as well as for the connection of a plug-in power cable.

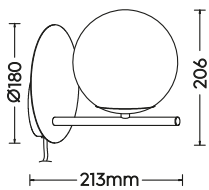

Wandleuchte · Wall lamp  
excl. 1 x E14  
max. 28 W  
**202000132**  
**202000142**

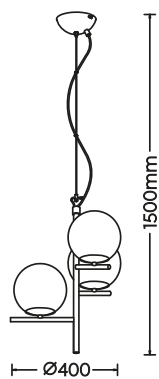

Pendelleuchte · Pendant  
excl. 3 x E14  
max. 28 W  
**302000332**  
**302000342**

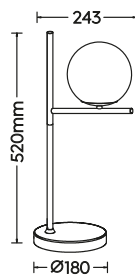

Tischleuchte · Table lamp  
excl. 1 x E14  
max. 28 W  
**502000132**  
**502000142**

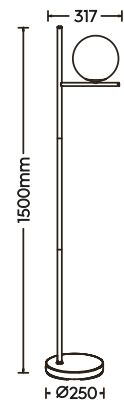



Stehleuchte · Floor lamp  
excl. 1 x E14  
max. 28 W  
**402000132**  
**402000142**





# PURE

Metall, Glas Weiß oder rauchfarbig ·  
metal, white or smoked glass

-  32 | Schwarz matt · black mat
-  42 | Anthrazit · anthracite



# PURE

Einfach und dennoch äußerst stilvoll! Egal, ob der Einrichtungsstil schlicht und gradlinig oder eher verspielt ist – die Leuchten der Serie PURE setzen dezente Akzente und verleihen jedem Raum eine besondere Note.

Simple and yet extremely stylish! Regardless of whether the furnishing style is simple and straightforward or more playful - the lights in the PURE range set subtle accents and add a special touch to any room.

Metall, Glas Weiß · metal, glass white

08 | Messing matt · brass mat

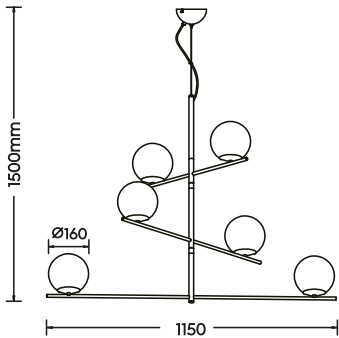
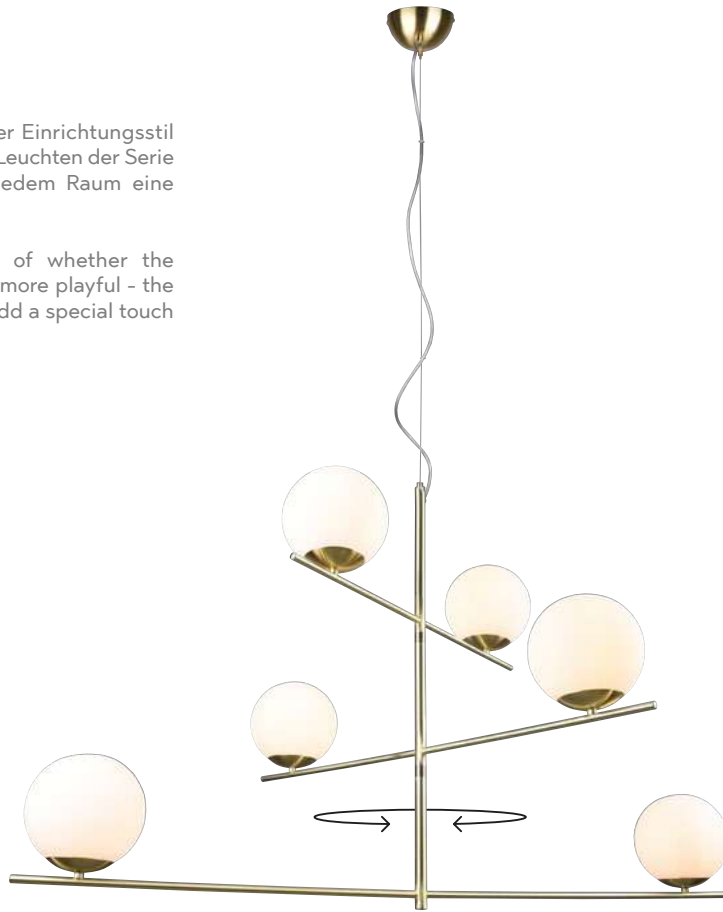

Pendelleuchte · Pendant  
excl. 6 x E14  
max. 28 W  
302000608

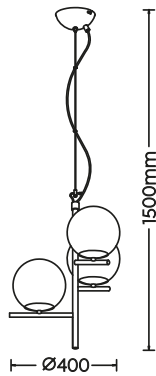

Pendelleuchte · Pendant  
excl. 3 x E14  
max. 28 W  
302000308

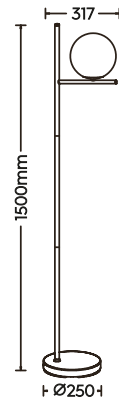

Stehleuchte · Floor lamp  
excl. 1 x E14  
max. 28 W  
402000108





Diese Wandleuchte ist sowohl für den Festanschluss, als auch für den Betrieb mit Steckerzuleitung geeignet.

This wall light is suitable both for a fixed power connection, as well as for the connection of a plug-in power cable.

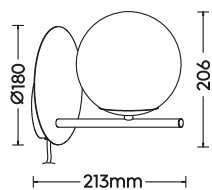

Wandleuchte · Wall lamp  
excl. 1 x E14  
max. 28 W  
**202000108**

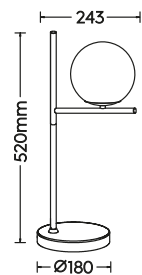

Tischleuchte · Table lamp  
excl. 1 x E14  
max. 28 W  
**502000108**



# FOMENTO NEW

Die Leuchtenserie besticht durch ihr schlichtes und zeitloses Design, das sich harmonisch in jede Einrichtung einfügt. Die Verwendung von hochwertigem Opalglas sorgt für eine gleichmäßige und angenehme Lichtverteilung, die eine warme und einladende Atmosphäre schafft.

The luminaire series impresses with its simple and timeless design, which blends harmoniously into any interior. The use of high-quality opal glass ensures even and pleasant light distribution, creating a warm and inviting atmosphere.

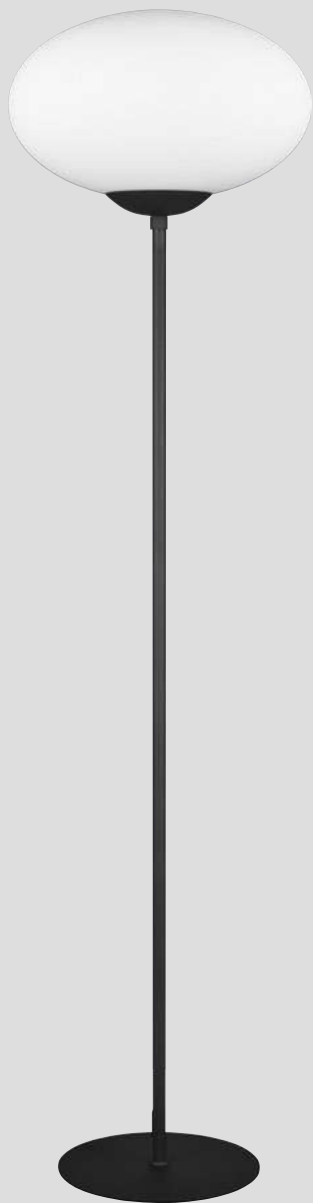

Stehleuchte · Floor lamp  
excl. 1 x E27  
max. 15 W  
463100108  
463100132

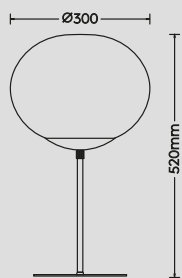

Tischleuchte · Table lamp  
excl. 1 x E27  
max. 15 W  
563100108  
563100132

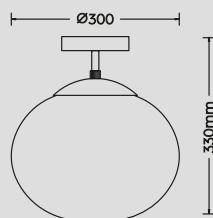

Deckenleuchte · Ceiling lamp  
excl. 1 x E27  
max. 15 W  
663100108  
663100132







Metall, Glas · metal, glass

 **08** | Messing matt · brass mat

 **32** | Schwarz matt · black mat

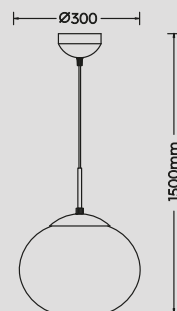

Pendelleuchte · Pendant  
 excl. 1 x E27  
 max. 15 W  
**363100108**  
**363100132**

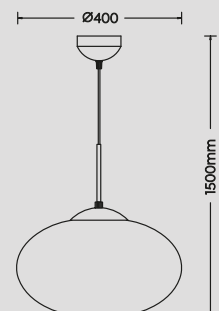

Pendelleuchte · Pendant  
 excl. 1 x E27  
 max. 15 W  
**363190108**  
**363190132**



# VAPORE

Die Leuchterserie VAPORE zeichnet sich durch ihr luxuriöses Design aus. Der funkelnde Behang aus Kristallglas reflektiert das Licht auf beeindruckende Weise.

The VAPORE luminaire series is characterised by its luxurious design. The sparkling crystal glass shade reflects the light in an impressive way.



Metal, Glas chrom bedampft · metal, chromium plated glass

06 | Chrome · chrome

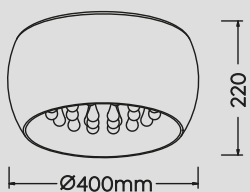

Deckenleuchte · Ceiling lamp  
excl. 5 x G9  
max. 42 W  
611210506

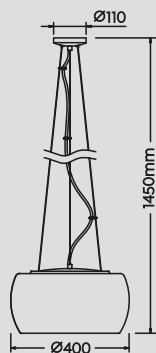

Pendelleuchte · Pendant  
excl. 5 x G9  
max. 42 W  
311210506

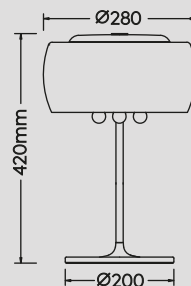

Tischleuchte · Table lamp  
excl. 3 x G9  
max. 42 W  
511210306



Empfohlen:  
recommended:

LED G9  
3 W / 300 Lumen  
3.000 Kelvin  
929-230



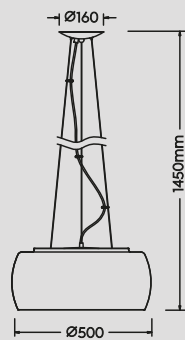

Pendelleuchte · Pendant

excl. 6 x G9  
max. 42 W

**311210606**

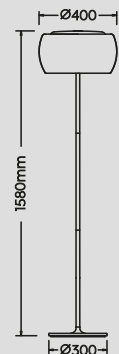

Stehleuchte · Floor lamp

excl. 4 x G9  
max. 42 W

**411210406**



# LUCERNA

Der funkelnde Behang aus Kristallglas reflektiert das Licht auf atemberaubende Weise und sorgt für einen Hauch von Glamour.

The sparkling crystal glass hanging reflects the light in a breathtaking way and adds a touch of glamour.

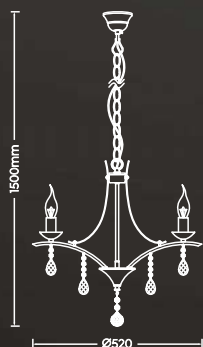

Lüster · Chandelier  
excl. 5 x E14  
max. 40 W  
101600506

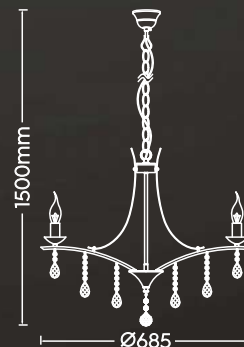

Lüster · Chandelier  
excl. 8 x E14  
max. 40 W  
101600806

Metall, Acryl · metal, acryl



06 | Chrome · chrome





# VALENTE

Diese Pendelleuchte beeindruckt mit ihrem eleganten Glasdesign, das jedem Raum eine stilvolle Note verleiht. Der rauchfarbene Glasschirm verteilt das Licht gleichmäßig und schafft eine angenehme Atmosphäre.

This pendant light impresses with its elegant glass design, which adds a stylish touch to any room. The smoke-coloured glass shade distributes the light evenly and creates a pleasant atmosphere.

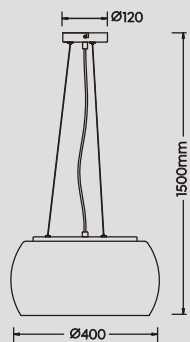

Pendelleuchte · Pendant

excl. 3 x E27

max. 60 W

300600342



Metall, Glas rauchfarbig ·  
metal, smoked glass



42 | Anthrazit · anthracite



# CALAIS

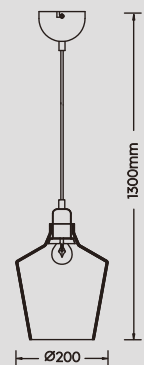

Pendelleuchte · Pendant  
excl. 1 x E27  
max. 60 W  
**304800142**

Glas rauchfarbig · smoked glass



42 | Anthrazit · anthracite



# DISCALGO

Das besondere Design sorgt nicht nur für eine optimale Beleuchtung, sondern auch für eine ästhetische Aufwertung des Raumes. Die dekorativen Elemente schaffen ein harmonisches Zusammenspiel von Licht und Schatten.

The special design not only ensures optimum lighting, but also enhances the aesthetics of the room. The decorative elements create a harmonious interplay of light and shadow.

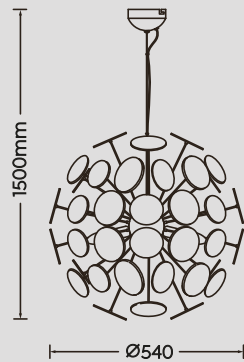
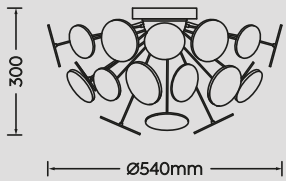
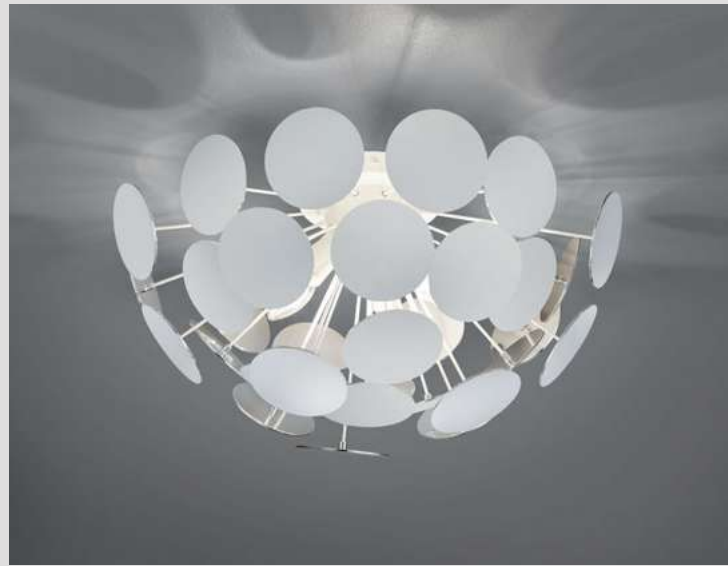

Deckenleuchte · Ceiling lamp

excl. 3 x E14  
max. 40 W

609900331  
609900332

Pendelleuchte · Pendant

excl. 6 x E14  
max. 40 W

309900631  
309900632



Metall, Kunststoff · metal, plastic

31 | Weiß matt · white mat

32 | Schwarz matt · black mat



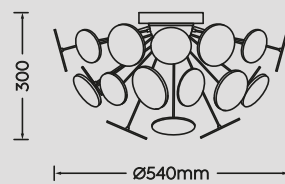

Deckenleuchte · Ceiling lamp  
excl. 3 x E14  
max. 40 W  
609900357

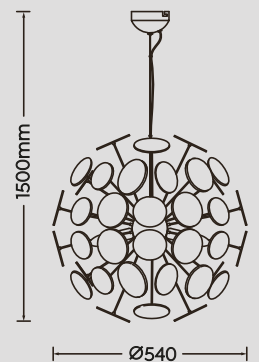

Pendelleuchte · Pendant  
excl. 6 x E14  
max. 40 W  
309900657



Metall Schwarz matt, Glas · metal black mat, glass

57 | Chrom bedampft · chrome plated

# ROMINO II

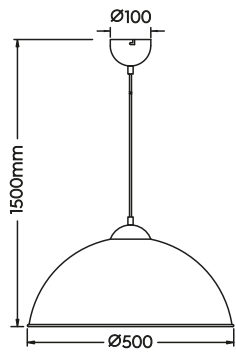

Pendelleuchte · Pendant

excl. 1 x E27  
max. 60 W

308000132



Metall, innen goldfarbig ·  
metal, gold colored inside



32 | Schwarz matt · black mat





# LORELEY

Diese exquisite Leuchte vereint Eleganz und Luxus in einem einzigartigen Design. Der Stoffschirm ist innen in einem warmen Goldton gehalten, der das Licht sanft reflektiert und eine behagliche Atmosphäre schafft.

This exquisite light combines elegance and luxury in a unique design. The fabric shade has a warm golden colour on the inside, which gently reflects the light and creates a cosy atmosphere.



Metall Chrom, Acryl, Stoffschirm · metal chrome, acryl, fabric shade



02 | Schwarz · black

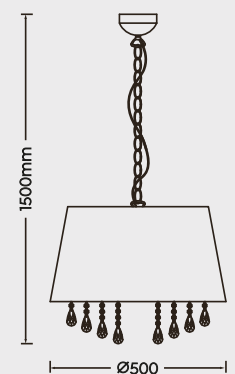

Pendelleuchte · Pendant

excl. 3 x E14  
max. 40 W

309300302



IP20

# ROBIN

Die Kombination aus Rauchglas und Metall strahlt moderne Eleganz aus.

The combination of smoked glass and metal radiates modern elegance.



Metall, Glas rauchfarbig · metal, smoked glass

 32 | Schwarz matt · black mat

 54 | Messing matt · brass mat

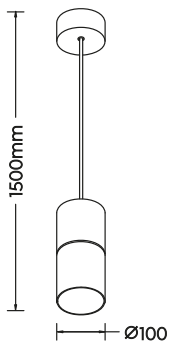

Pendelleuchte · Pendant

excl. 1 x E27  
max. 28 W

310600132  
310600154

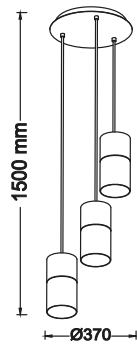

Pendelleuchte · Pendant

excl. 3 x E27  
max. 28 W

310630332  
310630354

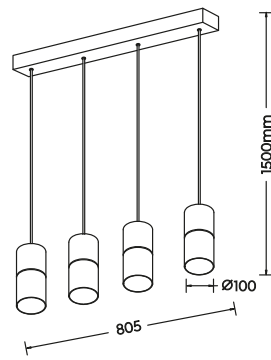

Pendelleuchte · Pendant

excl. 4 x E27  
max. 28 W

310600432  
310600454





# STANLEY

Eleganz mit moderner Funktionalität - Klassische Designs werden neu interpretiert und mit einer höhenverstellbaren Aufhängung ausgestattet, die maximale Flexibilität bietet.

Elegance with modern functionality - Classic designs are reinterpreted and equipped with a height-adjustable suspension that offers maximum flexibility.

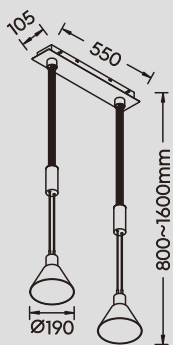

Pendelleuchte · Pendant  
excl. 2 x E27  
max. 40 W  
319500207  
319500232

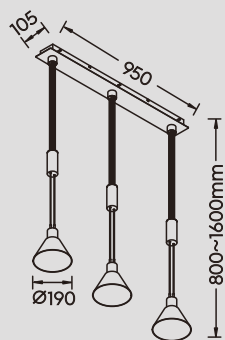

Pendelleuchte · Pendant  
excl. 3 x E27  
max. 40 W  
319500307  
319500332

Metall, Glas weiß oder rauchfarbig ·  
metal, glass white or smoke

07 | Nickel matt · nickel mat

32 | Schwarz matt · black mat





# STAMINA

Metall, Glas matt · metal, mat glass

07 | Nickel matt · nickel mat

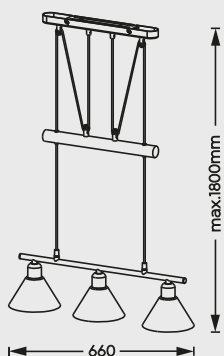

Pendelleuchte · Pendant  
excl. 3 x E14  
max. 40 W  
**3751031-07**

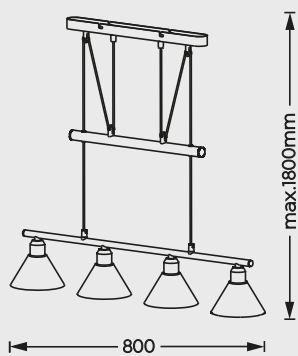

Pendelleuchte · Pendant  
excl. 4 x E14  
max. 40 W  
**3751041-07**

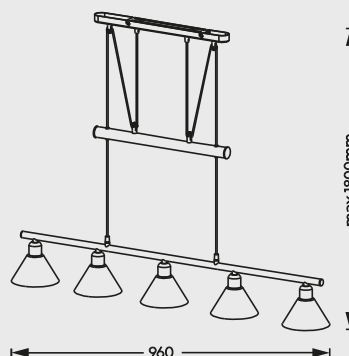

Pendelleuchte · Pendant  
excl. 5 x E14  
max. 40 W  
**3751051-07**





# LEVISTO

Metall, Glas alabasterfarbig ·  
metal, alabaster-coloured glass



**07** | Nickel matt · nickel mat



**08** | Messing matt · brass mat

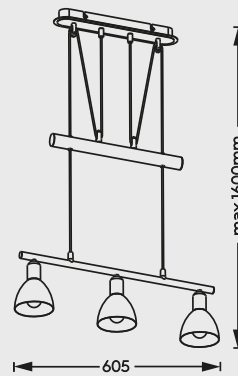
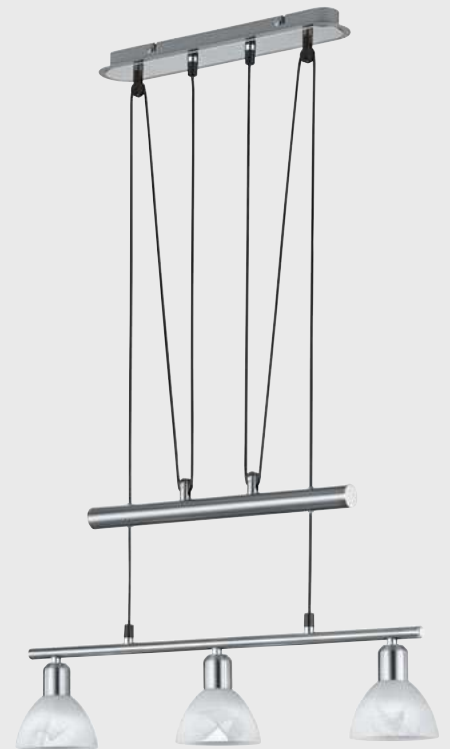

Pendelleuchte · Pendant  
incl. LED E14  
3 x 4,9 W / 3 x 470 Lumen  
3.000 Kelvin  
**371010307**  
**371010308**

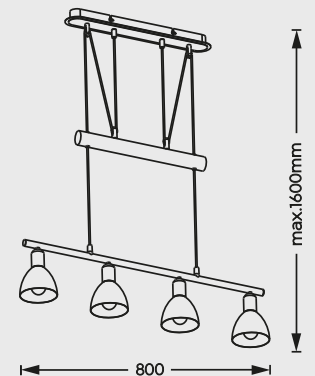

Pendelleuchte · Pendant  
incl. LED E14  
3 x 4,9 W / 4 x 470 Lumen  
3.000 Kelvin  
**371010407**  
**371010408**



# SIGNA

Schick und Zeitlos zugleich - Die Glasleuchtenserie SIGNA ist die perfekte Wahl für alle, die junges Wohnen mit einem Hauch von Eleganz und Modernität verbinden möchten.

Chic and timeless at the same time - the SIGNA glass luminaire range is the perfect choice for anyone who wants to combine young living with a touch of elegance and modernity.

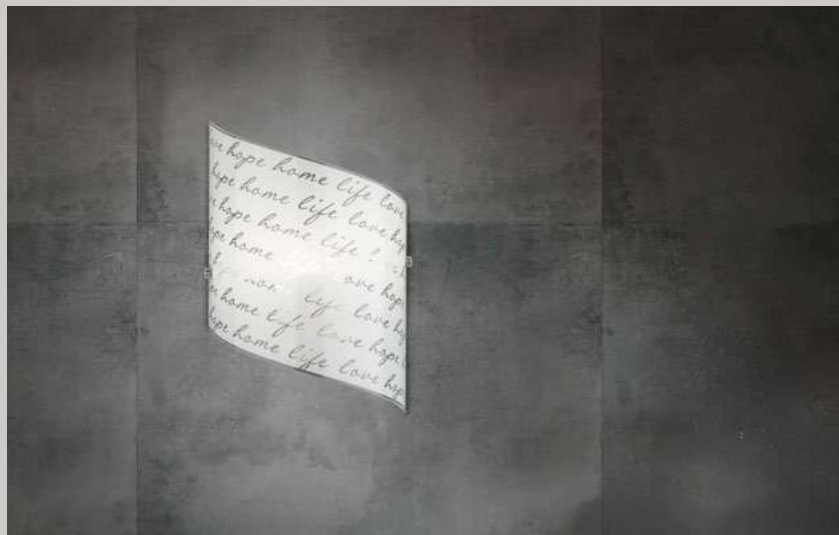
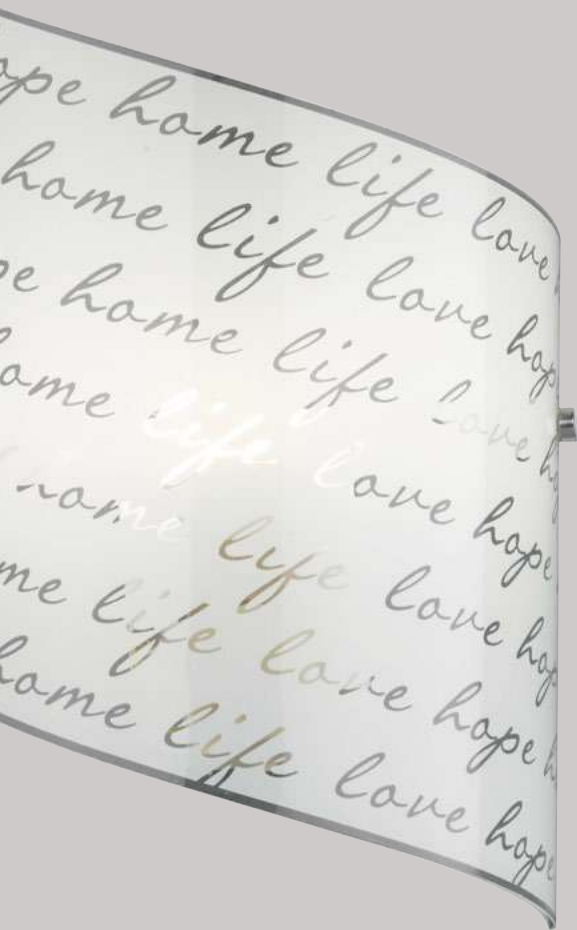
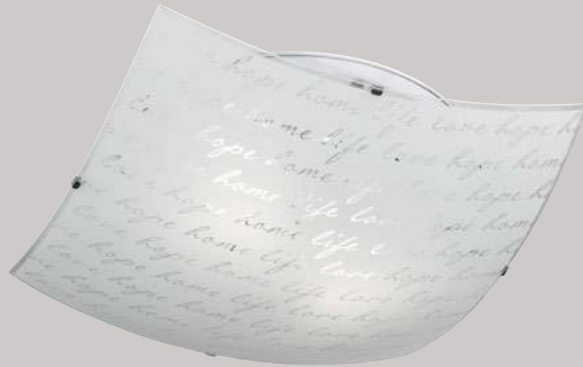
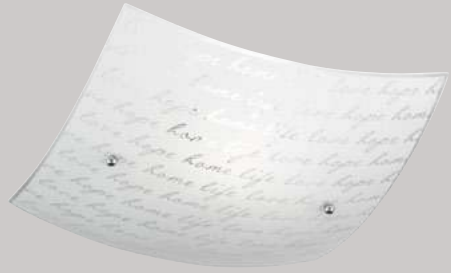

Metall Chrom, Dekorglas · metal chrome, glass decorated

01 | Weiß · white

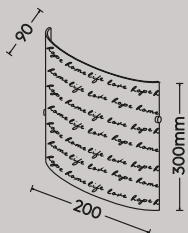

Wandleuchte · Wall lamp  
excl. 1 x E27  
max. 40 W  
202500101

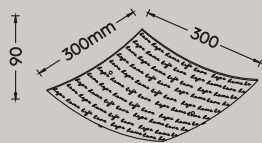

Deckenleuchte · Ceiling lamp  
excl. 1 x E27  
max. 40 W  
602500101

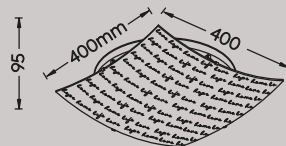

Deckenleuchte · Ceiling lamp  
excl. 2 x E27  
max. 40 W  
602500201



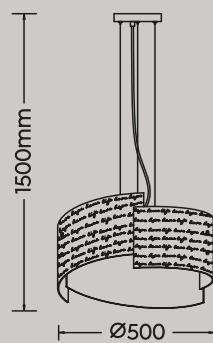

Pendelleuchte · Pendant  
excl. 3 x E27  
max. 40 W  
**302500301**





# SANDRINA

Die Serie SANDRINA überzeugt durch klassisches und zeitloses Design. Das Glas mit Kristalleffekt filtert das Licht auf harmonische Weise und schafft eine effektvolle Lichtstimmung.

The SANDRINA series impresses with its classic and timeless design. The crystal-effect glass filters the light in a harmonious way and creates an effective lighting atmosphere.

Metall Chrom, Dekorglas ·  
metal chrome, glass decorated

○ 00 | Transparent · transparent

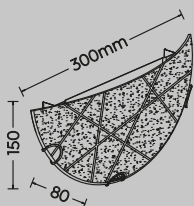
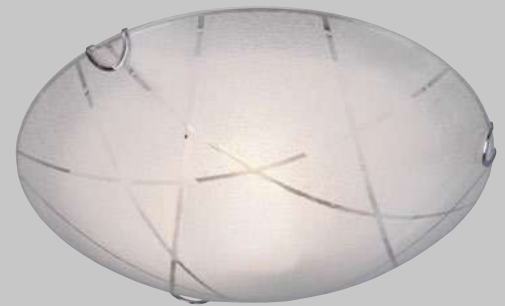

Wandleuchte · Wall lamp  
excl. 1 x E27  
max. 40 W  
**201200100**

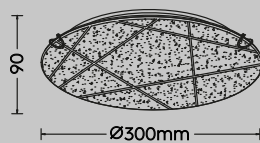

Deckenleuchte · Ceiling lamp  
excl. 1 x E27  
max. 40 W  
**601200100**

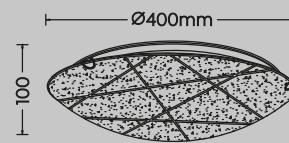

Deckenleuchte · Ceiling lamp  
excl. 2 x E27  
max. 40 W  
**601200200**

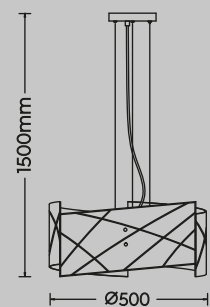

Pendelleuchte · Pendant  
excl. 3 x E27  
max. 40 W  
**301200300**



# SPIRELLI

Die Serie SPIRELLI vereint modernes und klassisches Design auf harmonische Weise. Das transparente Dekorglas sorgt für eine elegante und zeitlose Optik.

The SPIRELLI range harmoniously combines modern and classic design. The transparent decorative glass creates an elegant and timeless look.



Metall Chrom, Dekorglas ·  
metal chrome, glas decorated



01 | Weiß · white

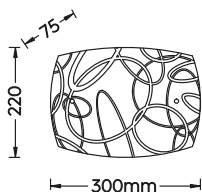

Wandleuchte · Wall lamp

excl. 1 x E27  
max. 40 W

204400101



IP20

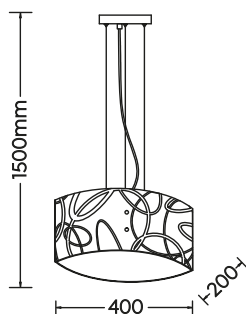

Pendelleuchte · Pendant

excl. 2 x E27  
max. 40 W

304400201



IP20

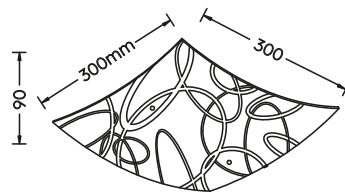
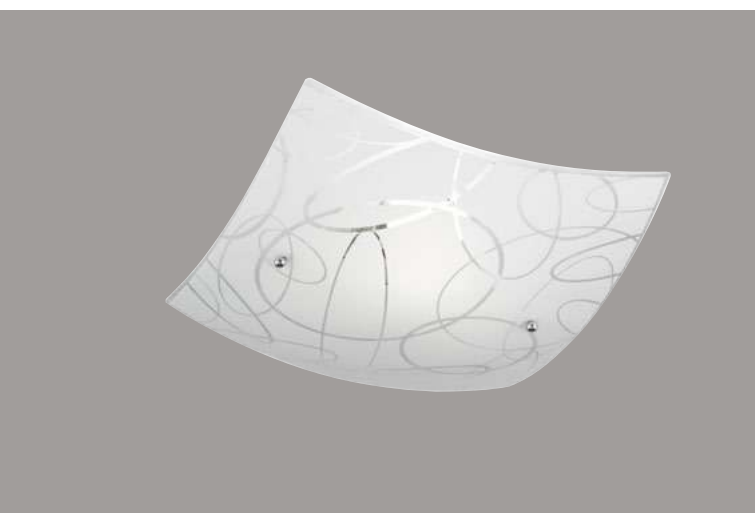

Deckenleuchte · Ceiling lamp  
 excl. 1 x E27  
 max. 40 W  
**604400101**

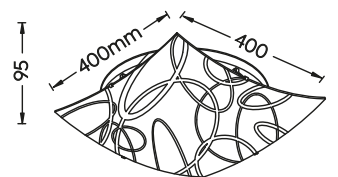

Deckenleuchte · Ceiling lamp  
 excl. 2 x E27  
 max. 40 W  
**604400201**



# ELISA

Das Glasdekor wird zum Hingucker in jedem Wohnkonzept und sorgt mit individuellen Lichtakzenten für ein gemütliches und harmonisches Ambiente.

The glass decor is an eye-catcher in any living concept and creates a cosy and harmonious ambience with individual lighting accents.



Metall Chrom, Glas · metal chrome, glass

00 | Transparent · transparent

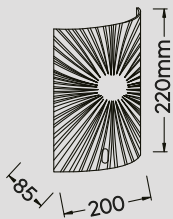

Wandleuchte · Wall lamp  
excl. 1 x E27  
max. 40 W  
212200100

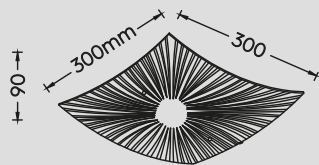

Deckenleuchte · Ceiling lamp  
excl. 1 x E27  
max. 40 W  
612200100

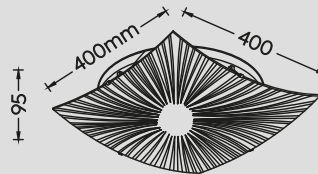

Deckenleuchte · Ceiling lamp  
excl. 2 x E27  
max. 40 W  
612200200

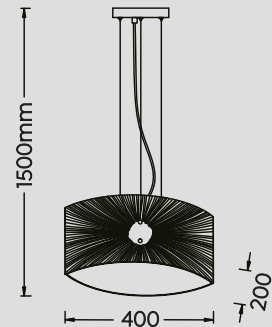

Pendelleuchte · Pendant  
excl. 2 x E27  
max. 40 W  
312200200







# ZUCCA

Metall Chrom, Acryl ·  
metal chrome, acryl

○ 00 | Transparent · transparent

◐ 06 | Chrome · chrome

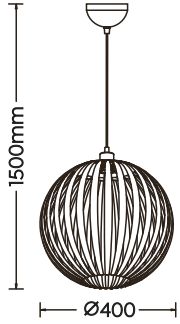

Pendelleuchte · Pendant

excl. 1 x E27  
max. 60 W

304100100

304100106



# DIEGO

Kunststoff aluminiumfarbig, Glas ·  
plastic aluminium, glass

○ 01 | Weiß · white

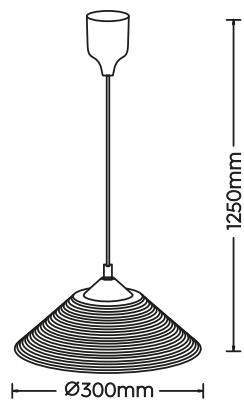

Pendelleuchte · Pendant

excl. 1 x E27  
max. 40 W

301400101



# VIOLA



Metall, Glas alabasterfarbig ·  
metal, alabaster-coloured glass

- 07 | Nickel matt · nickel mat
- 08 | Messing matt · brass mat

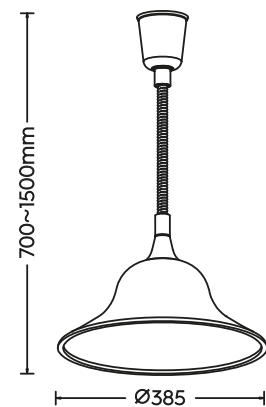

Pendelleuchte · Pendant

excl. 1 x E27  
max. 40 W

301700107

301700108



# PAPER

Papier · paper

01 | Weiß · white

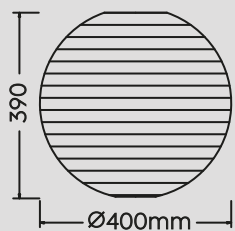

Pendelleuchte · Pendant

excl. 1 x E27  
max. 60 W  
VE / moq: 25  
3490400-00



excl. 1 x E27  
max. 60 W  
VE / moq: 25  
3590010-01



# FILO

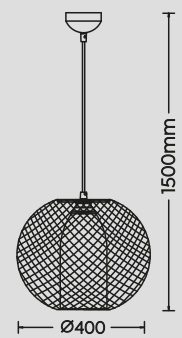

Pendelleuchte · Pendant  
excl. 1 x E27  
max. 60 W  
**313900132**

Metall, Glas weiß · metal, glass white



**32** | Schwarz matt · black mat







# ROSS

Die Metallkomponenten verleihen den Leuchten eine robuste Struktur, während die Stoffschirme ein weiches, diffuses Licht erzeugen, das eine warme und einladende Atmosphäre schafft.

The metal components give the lights a robust structure, while the fabric shades produce a soft, diffuse light that creates a warm and inviting atmosphere.

Metall Schwarz matt, Stoffschirm · metal black mat, fabric shade

 17 | mehrfarbig · multicolor

 44 | Beige · fawn

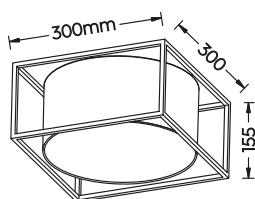

Deckenleuchte · Ceiling lamp  
excl. 2 x E27  
max. 25 W  
603100244

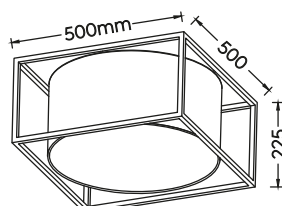

Deckenleuchte · Ceiling lamp  
excl. 3 x E27  
max. 25 W  
603100344

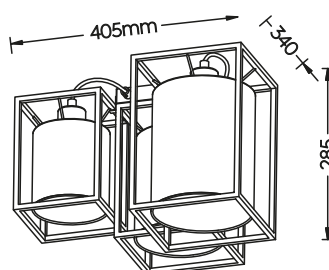

Deckenleuchte · Ceiling lamp  
excl. 3 x E27  
max. 25 W  
603130317

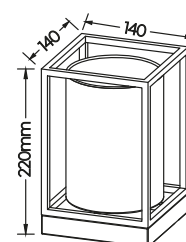

Tischleuchte · Table lamp  
excl. 1 x E27  
max. 25 W  
503100144





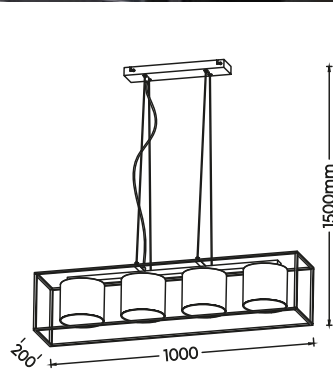

Pendelleuchte · Pendant  
 excl. 4 x E27  
 max. 25 W  
 303100417

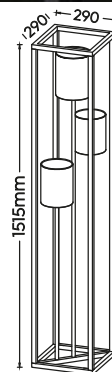

Stehleuchte · Floor lamp  
 excl. 3 x E27  
 max. 25 W  
 403100317



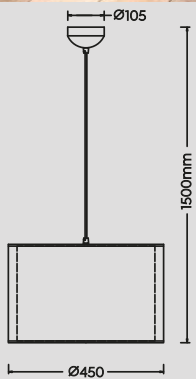

Pendelleuchte · Pendant  
 excl. 1 x E27  
 max. 40 W  
 311400132

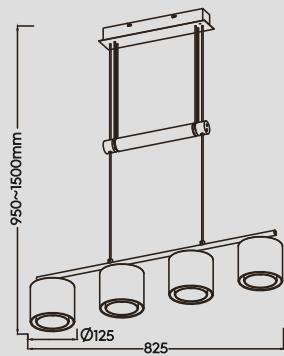

Pendelleuchte · Pendant  
 excl. 4 x E14  
 max. 28 W  
 311400432



# BURTON

Die weißen Stoffschirme sorgen für blendfreies Licht. Die äußeren schwarzen Mesh-Schirme verleihen den Leuchten einen besonderen Charme.

The white fabric shades provide glare-free light. The outer black mesh shades give the lights a special charm.

Metall, Stoffschirm · metal, fabric shade

32 | Schwarz matt · black mat

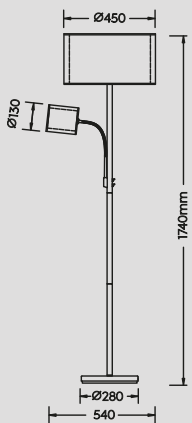

Stehleuchte · Floor lamp  
excl. 1 x E27, max. 60 W  
excl. 1 x E14, max. 40 W  
411400232

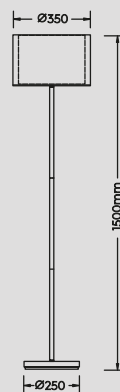

Stehleuchte · Floor lamp  
excl. 1 x E27  
max. 40 W  
411400132

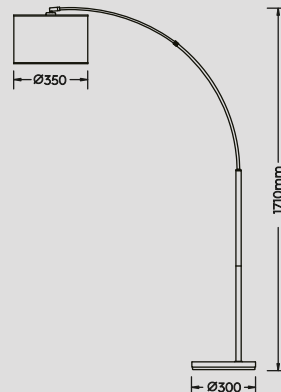

Stehleuchte · Floor lamp  
excl. 1 x E27  
max. 10 W  
411490132



# BURTON

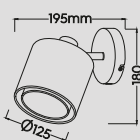

Strahler · Spot  
excl. 1 x E14  
max. 28 W  
811400132

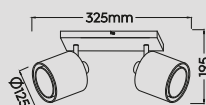

Strahler · Spot  
excl. 2 x E14  
max. 28 W  
811400232

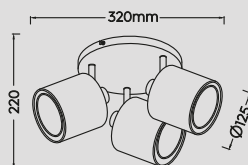

Strahler · Spot  
excl. 3 x E14  
max. 28 W  
811430332

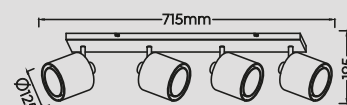

Strahler · Spot  
excl. 4 x E14  
max. 28 W  
811400432





Metall, Stoffschirm · metal, fabric shade

32 | Schwarz matt · black mat

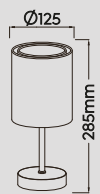

Tischleuchte · Table lamp  
excl. 1 x E14  
max. 28 W  
511400132

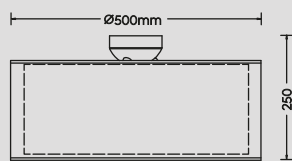

Deckenleuchte · Ceiling lamp  
excl. 3 x E27  
max. 40 W  
611400332

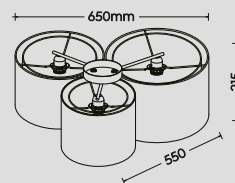

Deckenleuchte · Ceiling lamp  
excl. 3 x E27  
max. 40 W  
611490332

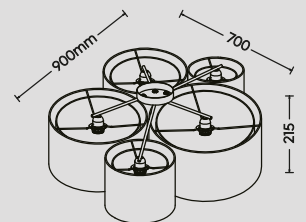

Deckenleuchte · Ceiling lamp  
excl. 5 x E27  
max. 40 W  
611400532





Metall Nickel matt, Stoffschirm ·  
metal nickel mat, fabric shade

- 01** | Weiß · white
- 02** | Schwarz · black
- 11** | Grau · grey

Wandleuchte · Wall lamp

excl. 1 x E14  
max. 40 W  
incl. SMD-LED  
3,1 W / 310 Lumen  
3.000 Kelvin

**271170201**  
**271170202**  
**271170211**

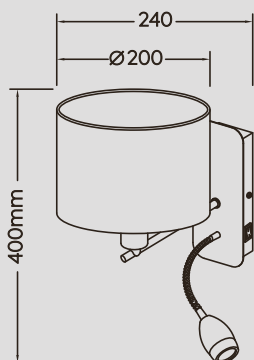

Getrennt schaltbar ·  
Separately switchable

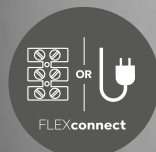

# HOTEL

Die Leuchten der Serie HOTEL setzen stilvolle Lichtakzente in jedem Wohnbereich. Egal ob modern oder klassisch eingerichtet – sie fügen sich harmonisch in jeden Raum ein und kommen überall perfekt zur Geltung.

The lights in the HOTEL range create stylish lighting accents in any living area. Whether modern or classically furnished - they blend harmoniously into any room and are perfectly accentuated everywhere.



Metall Nickel matt, Stoffschirm ·  
metal nickel mat, fabric shade



**01** | Nickel matt, Schirm weiß ·  
nickel mat, shade white

**08** | Messing matt, Schirm Creme-Weiß ·  
brass mat, shade cream white

**11** | Nickel matt, Schirm Grau ·  
nickel mat, shade grey

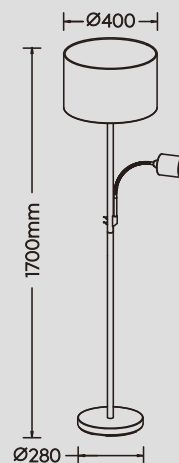

Stehleuchte · Floor lamp

excl. 1 x E27, max. 60 W

excl. 1 x E14, max. 18 W

403900201

403900208

403900211



IP20

# HOTEL



Metall Nickel matt, Stoffschirm ·  
metal nickel mat, fabric shade

-  **01** | Weiß · white
-  **02** | Schwarz · black
-  **11** | Grau · grey

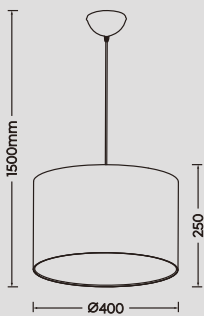

Pendelleuchte · Pendant

excl. 1 x E27  
max. 60 W

303300102  
303300111

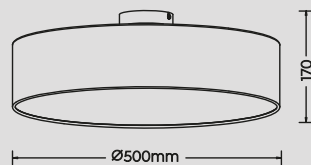

Deckenleuchte · Ceiling lamp

excl. 3 x E27  
max. 60 W

603900301  
603900302  
603900311

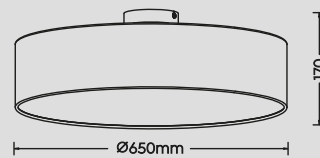

Deckenleuchte · Ceiling lamp

excl. 5 x E27  
max. 60 W

603900501  
603900502  
603900511







Metall, Stoffschirm · metal, fabric shade



17 | mehrfarbig · multicolor

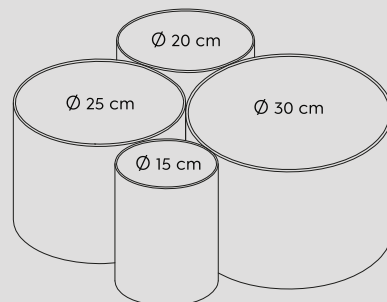

Deckenleuchte · Ceiling lamp  
 excl. 4 x E27  
 max. 42 W  
**693900417**

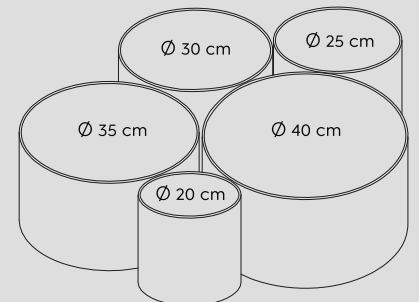

Deckenleuchte · Ceiling lamp  
 excl. 5 x E27  
 max. 42 W  
**693900517**



# HOTEL

Metall Nickel matt, Stoffschirm ·  
metal nickel mat, fabric shade

01 | Weiß · white

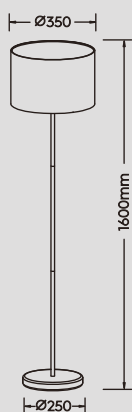

Stehleuchte · Floor lamp  
excl. 1 x E27  
max. 60 W  
401100101

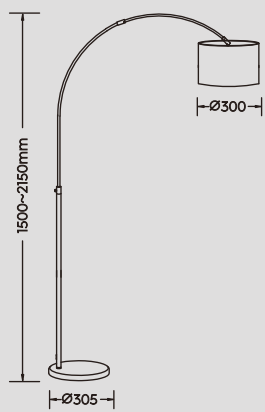

Stehleuchte · Floor lamp  
excl. 1 x E27  
max. 60 W  
461100101

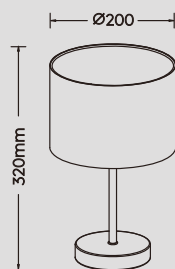

Tischleuchte · Table lamp  
excl. 1 x E14  
max. 40 W  
501100101

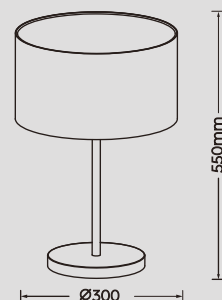

Tischleuchte · Table lamp  
excl. 1 x E27  
max. 60 W  
511100101





# GARDA

Gemütliche Essplatzbeleuchtung mit der Pendelleuchte GARDA. Die vierflammige JoJo-Pendelleuchte setzt Ihren Wohn- und Essbereich in Szene. Passende Decken- und Tischleuchten ergänzen das Ensemble.

Cosy dining area lighting with the GARDA pendant light. The four-light JoJo pendant light sets the scene in your living and dining area. Matching ceiling and table lamps complete the ensemble.

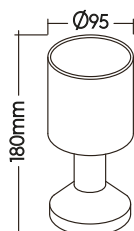
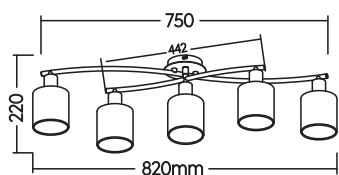

Deckenleuchte · Ceiling lamp

excl. 5 x E14  
max. 25 W

605400501

605400511

Tischleuchte · Table lamp

excl. 1 x E14, max. 25 W





595400101

595400111

595400179



Metall Nickel matt, Stoffschirm ·  
metal nickel mat, fabric shade

-  01 | Weiß · white
-  11 | Grau · grey
-  41 | Taupe · taupe
-  79 | goldfarbig · gold

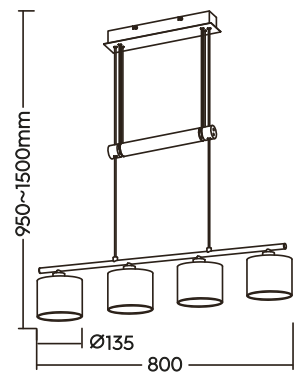

Pendelleuchte · Pendant

excl. 4 x E14  
max. 28 W

305400401

305400411

305400441



# CORTEZ

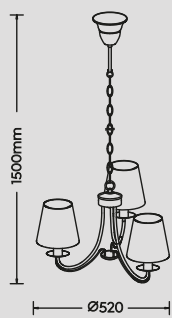

Pendelleuchte · Pendant  
excl. 3 x E14  
max. 28 W  
**110600331**

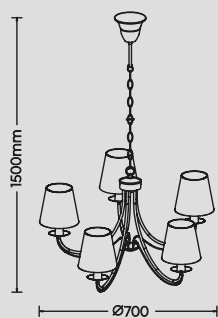

Pendelleuchte · Pendant  
excl. 5 x E14  
max. 28 W  
**110600531**



Metall, Stoffschirm · metal, fabric shade



**31** | Weiß matt · white mat



# KAPRUN NEW

Die warmen Farbnuancen der Stoffschirme verleihen den Leuchten eine individuelle Note und fügen sich harmonisch in verschiedene Einrichtungsstile ein.

The warm colour nuances of the fabric shades give the lights an individual touch and blend in harmoniously with different furnishing styles.



Metall, Stoffschirm ·  
metal, fabric shade



**06** | Chrome · chrome

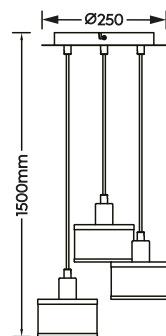

Pendelleuchte · Pendant  
excl. 3 x E14  
max. 28 W  
**311630306**

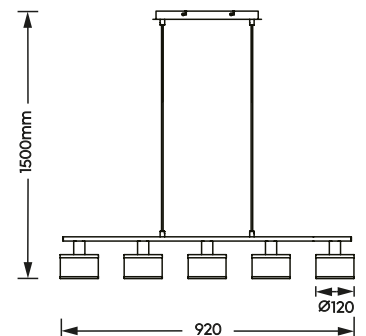

Pendelleuchte · Pendant  
excl. 5 x E14  
max. 28 W  
**311600506**



# JULIETA

Die klassische und schlichte Schönheit der Serie JULIETA wirkt elegant und stimmungsvoll. Die neutrale Farbe sowie der warm wirkende Samtstoff der Schirme hüllen die Leuchten in Gemütlichkeit ein und strahlen Ruhe aus.

The classic and simple beauty of the JULIETA range is elegant and atmospheric. The neutral colour and the warm velvet fabric of the shades wrap the lights in cosiness and radiate calm.



Metall Schwarz matt, Samt, innen goldfarbig · metal black mat, velvet, gold colored inside

44 | Beige · fawn

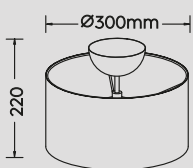

Deckenleuchte · Ceiling lamp  
excl. 2 x E14  
max. 40 W  
619000244

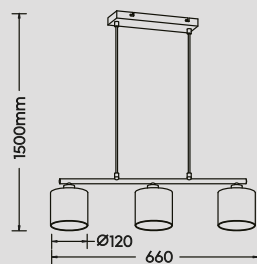

Pendelleuchte · Pendant  
excl. 3 x E14  
max. 40 W  
319000344

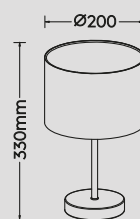

Tischleuchte · Table lamp  
excl. 1 x E27  
max. 40 W  
519000144

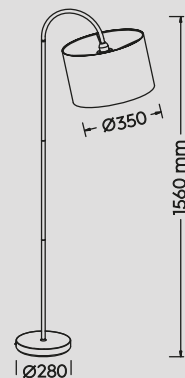

Stehleuchte · Floor lamp  
excl. 1 x E27  
max. 60 W  
419090144









Metall Schwarz matt, Stoffschirm Schwarz matt, innen goldfarbig · metal black mat, fabric shade black mat, gold colored inside

 79 | goldfarbig · gold

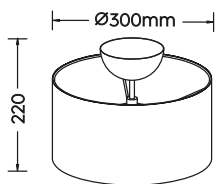

Deckenleuchte · Ceiling lamp  
excl. 2 x E14  
max. 40 W  
608200279

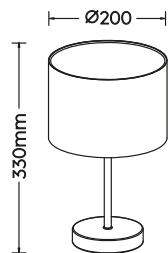

Tischleuchte · Table lamp  
excl. 1 x E27  
max. 40 W  
508200179

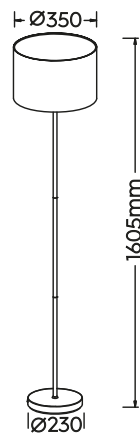

Stehleuchte · Floor lamp  
excl. 1 x E27  
max. 60 W  
408200179





# HOSTEL

Die Leuchtenserie HOSTEL ist die perfekte Wahl für alle, die eine gemütliche Atmosphäre mit einem Hauch von Eleganz in ihrem Zuhause schaffen möchten. Die Kombination aus Schwarz und Gold verleiht jedem Raum eine besondere Note und sorgt für stilvolle Lichtakzente.

The HOSTEL luminaire series is the perfect choice for anyone who wants to create a cosy atmosphere with a touch of elegance in their home. The combination of black and gold adds a special touch to any room and provides stylish lighting accents.

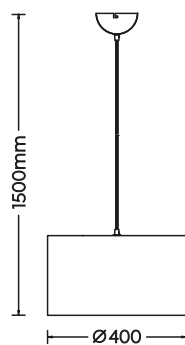

Pendelleuchte · Pendant  
 excl. 1 x E27  
 max. 60 W  
**308200179**

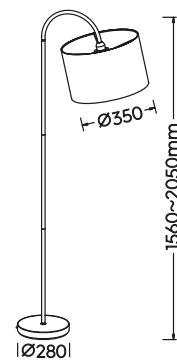

Stehleuchte · Floor lamp  
 excl. 1 x E27  
 max. 60 W  
**408290179**







# WAND- & DECKEN LEUCHTEN

## WALL & CEILING LAMPS

Die Kombination von Wand- und Deckenleuchten kann eine harmonische und flexible Beleuchtungslösung schaffen, die sowohl funktional als auch stilvoll ist. Ob dimmbar oder mit speziellen Lichtfarben – die Möglichkeiten sind vielfältig und bieten für jeden Raum und Geschmack die passende Lösung.

The combination of wall and ceiling lights can create a harmonious and flexible lighting solution that is both functional and stylish. Whether dimmable or with special light colours - the options are diverse and offer the right solution for every room and taste.

# ZENO NEW

Die Deckenleuchte ZENO vereint modernste LED-Technik mit funktionaler Raffinesse. Diese innovative Leuchte bietet eine Kombination aus akzentuierter und direkter Beleuchtung. Ein absolutes Highlight ist die ausziehbare und horizontal verstellbare Funktion, die es ermöglicht, das Licht genau dort zu platzieren, wo es benötigt wird.

The ZENO ceiling light combines state-of-the-art LED technology with functional sophistication. This innovative luminaire offers a combination of accentuated and direct lighting. An absolute highlight is the extendable and horizontally adjustable function, which makes it possible to position the light exactly where it is needed.



<https://www.trio-lighting.com/zeno>



Lichtfarbe stufenlos einstellbar ·  
Light color infinitely variable



Integrierter Dimmer ·  
Integrated dimmer



Getrennt schaltbar ·  
Separately switchable

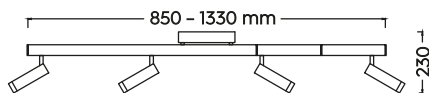

Deckenleuchte · Ceiling lamp

incl. SMD-LED  
4 x 5,5 W / 4 x 650 Lumen

incl. SMD-LED  
12 W / 1.500 Lumen  
2.700 - 6.500 Kelvin

648310505

648310532

648310580

Metall · metal



05 | Aluminium gebürstet · brushed Aluminium



32 | Schwarz matt · black mat



80 | Schwarz-Gold · black-gold



IP20



Ausziehbar ·  
Extendible

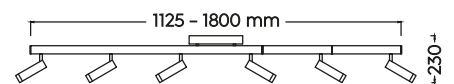

Deckenleuchte · Ceiling lamp

incl. SMD-LED

6 x 5,5 W / 6 x 650 Lumen

incl. SMD-LED

18 W / 2.200 Lumen

2.700 - 6.500 Kelvin

648310705

648310732

648310780



IP20

# CAYA

Metall · metal

- 05 | Aluminium gebürstet / Schwarz matt · brushed aluminium / black mat
- 08 | Messing matt / Schwarz matt · brass mat / black mat

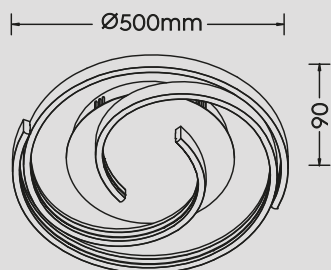

Deckenleuchte · Ceiling lamp

incl. SMD-LED

58 W / 6.800 Lumen

2.300 + 3.000 + 4.000 Kelvin

641910205

641910208



## SWITCH DIMMER

Helligkeit in 3 Stufen mit herkömmlichem Lichtschalter einstellbar.

Brightness adjustable in 4 levels with conventional light switch.



## DIP SWITCH

Mittels DIP-SWITCH können drei Lichtfarben (Warmweiß, Neutralweiß, Universalweiß) über einen Schalter direkt an der Leuchte eingestellt werden.  
The DIP SWITCH directly sets the luminaire's three light colours (warm, neutral and universal white).





# CARUSO NEW

Die geschwungene Form erinnert an Blütenblätter, während die drei zusätzlichen Downlights den Blütenstempel symbolisieren.

The curved shape is reminiscent of flower petals, while the three additional downlights symbolise the pistil.

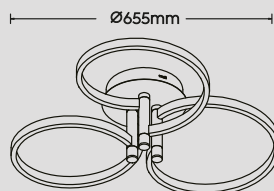

Deckenleuchte · Ceiling lamp  
incl. SMD-LED  
43 W / 4.980 Lumen  
2.300 + 3.000 + 4.000 Kelvin  
**648110605**  
**648110680**



## SWITCH DIMMER

Helligkeit in 3 Stufen mit herkömmlichem Lichtschalter einstellbar.

Brightness adjustable in 4 levels with conventional light switch.



## DIP SWITCH

Mittels DIP-SWITCH können drei Lichtfarben (Warmweiß, Neutralweiß, Universalweiß) über einen Schalter direkt an der Leuchte eingestellt werden.

The DIP SWITCH directly sets the luminaire's three light colours (warm, neutral and universal white).

Metall · metal

 **05** | Aluminium gebürstet · brushed Aluminium

 **80** | Schwarz-Gold · black-gold

# ZODIAC

Die außergewöhnlich Deckenleuchte bringt den Mond in greifbare Nähe. Durch den beeindruckenden 3D-Effekt, wird diese Leuchte zu einem wahren Blickfang.

This extraordinary ceiling light brings the moon within reach. The impressive 3D effect makes this light a real eye-catcher.



## SWITCH DIMMER

Helligkeit in 3 Stufen mit herkömmlichem Lichtschalter einstellbar.

Brightness adjustable in 4 levels with conventional light switch.



## DIP SWITCH

Mittels DIP-SWITCH können drei Lichtfarben (Warmweiß, Neutralweiß, Universalweiß) über einen Schalter direkt an der Leuchte eingestellt werden.

The DIP SWITCH directly sets the luminaire's three light colours (warm, neutral and universal white).

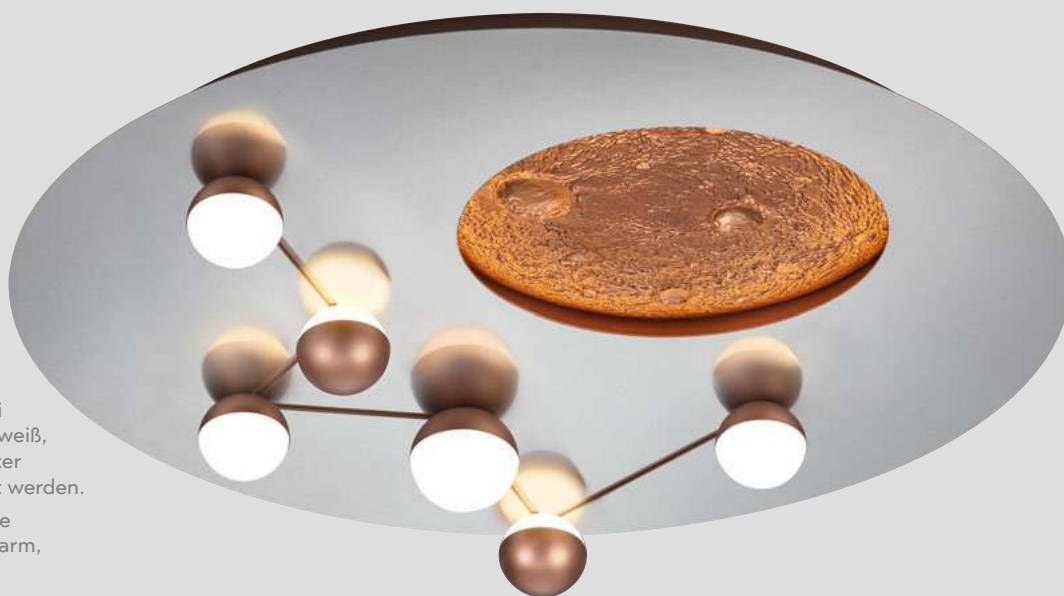

Metall · metal



07 | Nickel matt · nickel mat



32 | Schwarz matt · black mat

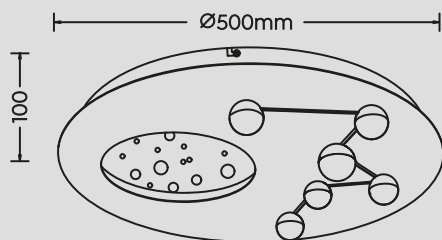

Deckenleuchte · Ceiling lamp

incl. SMD-LED

42 W / 5.100 Lumen

2.300 + 3.000 + 4.000 Kelvin

644810107

644810132



IP20



# PEBBLE NEW

Die Deckenleuchte PEBBLE beeindruckt durch ihre organischen Formen und der raffinierten Kombination aus direktem und indirektem Licht. Diese einzigartige Gestaltung lässt die Leuchte wie ein Kunstwerk erscheinen und verleiht jedem Raum eine besondere Ästhetik.

The PEBBLE ceiling light impresses with its organic shapes and sophisticated combination of direct and indirect light. This unique design makes the luminaire look like a work of art and lends any room a special aesthetic.



SWITCH DIMMER



Memory Funktion ·  
Memory function



Metall, Kunststoff · metal, plastic



**31** | Weiß matt · white mat



**32** | Schwarz matt · black mat

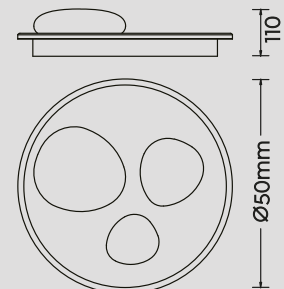

Deckenleuchte · Ceiling lamp

incl. SMD-LED  
36 W / 4.500 Lumen  
2.700 - 6.000 Kelvin

**643110131**

**643110132**



IP20

# MANDALA NEW

Diese Deckenleuchte vereint außergewöhnliches Design mit exzellenter Lichtqualität und ist in den neuesten Trendfarben erhältlich. Die innovative Formgebung und die hochwertigen Materialien machen sie zu einem echten Blickfang in jedem Raum. Das Licht wird gleichmäßig verteilt und sorgt für eine angenehme Atmosphäre.

This ceiling light combines exceptional design with excellent lighting quality and is available in the latest trendy colours. The innovative design and high-quality materials make it a real eye-catcher in any room. The light is distributed evenly and creates a pleasant atmosphere.



## SWITCH DIMMER

Helligkeit in 3 Stufen mit herkömmlichem Lichtschalter einstellbar.

Brightness adjustable in 4 levels with conventional light switch.



Metall · metal



**31** | Weiß matt · white mat



**76** | Warm Grau / Coffee · warm grey / coffee



**80** | Schwarz-Gold · black-gold

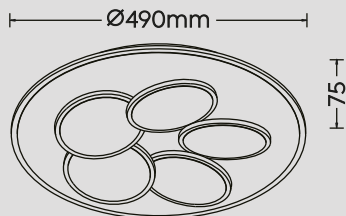

Deckenleuchte · Ceiling lamp

incl. SMD-LED

35 W / 4.200 Lumen

2.700 - 6.500 Kelvin

653210631

653210676

653210680



Lichtfarbe stufenlos einstellbar ·  
Light color infinitely variable



Integrierter Dimmer ·  
Integrated dimmer



Memory Funktion ·  
Memory function



Timer





# KAGAWA



Lichtfarbe stufenlos einstellbar ·  
Light color infinitely variable

Metall, Acryl · metal, acryl



31 | Weiß matt · white mat

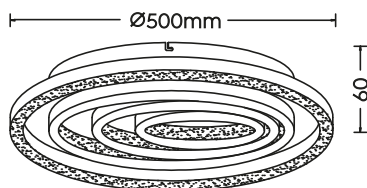

Deckenleuchte · Ceiling lamp

incl. SMD-LED

40 W / 5.000 Lumen

2.700 - 6.000 Kelvin

625815031



IP20

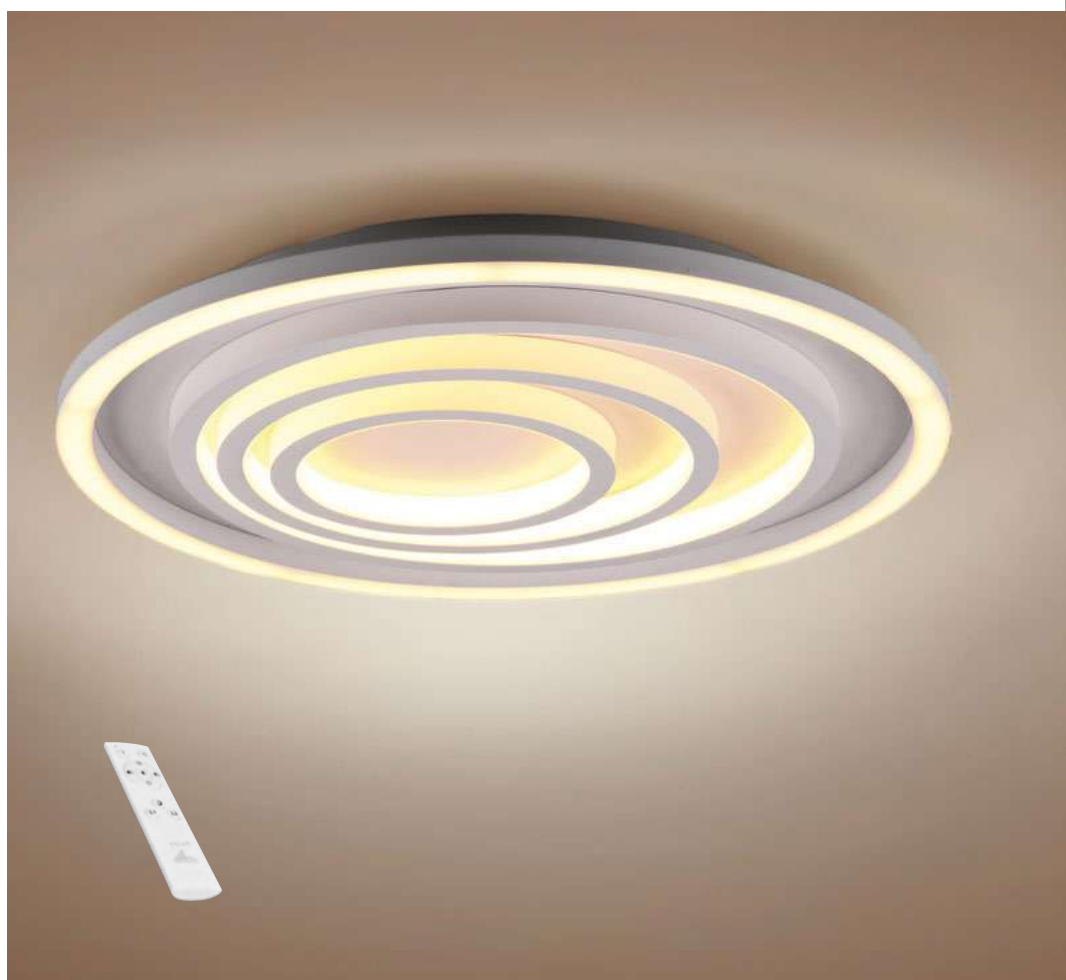

# AKITA



SWITCH DIMMER



Lichtfarbe stufenlos einstellbar ·  
Light color infinitely variable



Memory Funktion ·  
Memory function

Metall, Acryl · metal, acryl



31 | Weiß matt · white mat

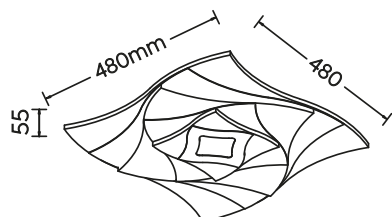

Deckenleuchte · Ceiling lamp

incl. SMD-LED

56 W / 6.550 Lumen

3.000 - 6.500 Kelvin

647110131



IP20



# MITA

Ob rund oder eckig – MITA beeindruckt mit ihrem außergewöhnlichen Design und verleiht jedem Raum eine elegante und stilvolle Note. Ihre vielseitige Formgebung macht sie zu einem Highlight in jeder Einrichtung und sorgt für eine harmonische Atmosphäre.

Whether round or square – MITA impresses with its unusual design and adds an elegant and stylish touch to any room. Its versatile design makes it a highlight in any interior and creates a harmonious atmosphere.



Lichtfarbe stufenlos einstellbar ·  
Light color infinitely variable



Integrierter Dimmer ·  
Integrated dimmer



Memory Funktion ·  
Memory function

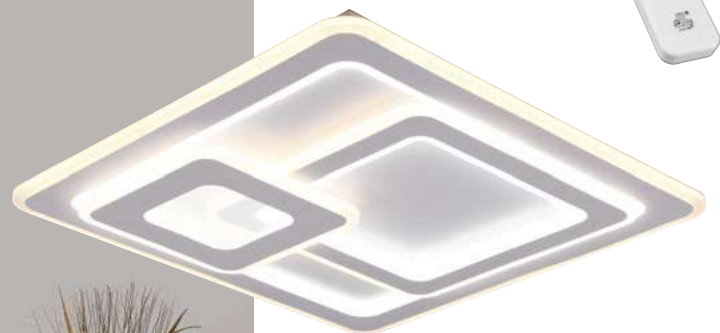

Metall, Acryl · metal, acryl



**31** | Weiß matt · white mat

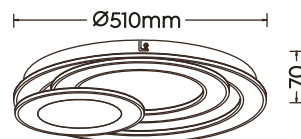
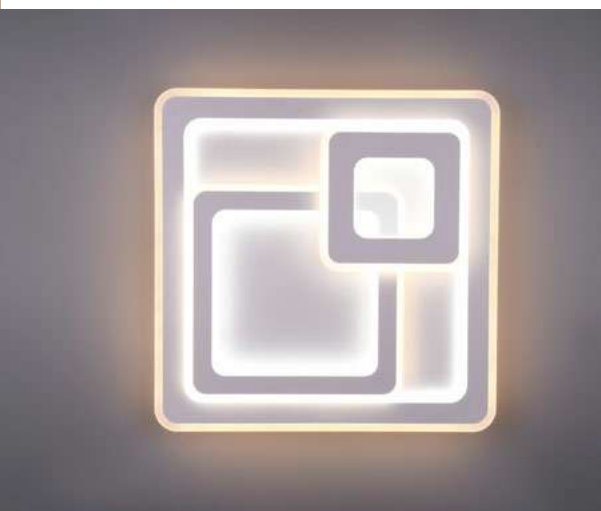

Deckenleuchte · Ceiling lamp  
incl. SMD-LED  
74 W / 9.000 Lumen  
2.700 - 6.000 Kelvin  
**629210331**

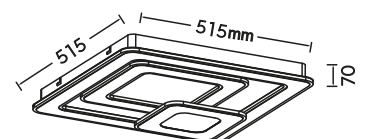

Deckenleuchte · Ceiling lamp  
incl. SMD-LED  
76 W / 9.250 Lumen  
2.700 - 6.000 Kelvin  
**629219331**





Metall, Acryl · metal, acryl

 **07** | Nickel matt · nickel mat

 **80** | Schwarz-Gold · black-gold

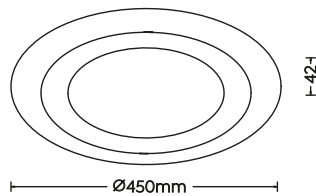
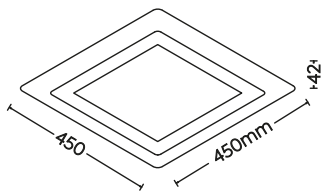

Deckenleuchte · Ceiling lamp

incl. SMD-LED  
46 W / 6.000 Lumen  
2.700 - 6.500 Kelvin

**641510207**  
**641510280**



Deckenleuchte · Ceiling lamp

incl. SMD-LED  
42 W / 5.600 Lumen  
2.700 - 6.500 Kelvin

**641519207**  
**641519280**





Mit wahlweise rundem oder eckigem Design bietet MORGAN eine elegante und außergewöhnliche Beleuchtungslösung, die stilvoll jeden Raum bereichert.

With a choice of round or angular design, MORGAN offers an elegant and unusual lighting solution that stylishly enhances any room.

# MORGAN



Lichtfarbe stufenlos einstellbar ·  
Light color infinitely variable



Integrierter Dimmer ·  
Integrated dimmer



Memory Funktion ·  
Memory function



Timer



# RISE NEW

Organische Formensprache und elegante Farbkombinationen machen die Deckenleuchte RISE zu einem echten Hingucker. Zudem lässt sich die Lichtfarbe flexibel einstellen und die Helligkeit kann nach Belieben angepasst werden.

Organic shapes and elegant colour combinations make the RISE ceiling light a real eye-catcher. The light colour can also be set flexibly and the brightness can be adjusted as required.



Lichtfarbe stufenlos einstellbar ·  
Light color infinitely variable



Integrierter Dimmer ·  
Integrated dimmer



Memory Funktion ·  
Memory function

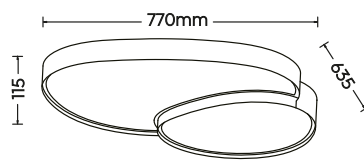
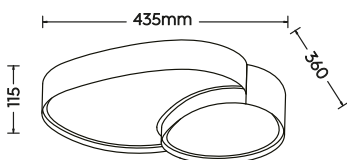
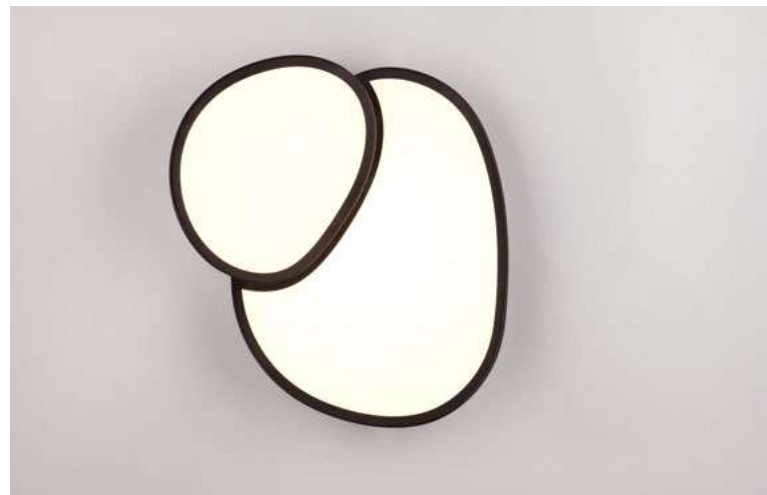

Deckenleuchte · Ceiling lamp

incl. SMD-LED  
21 W / 2.400 Lumen  
2.700 - 6.500 Kelvin

**647510231**

**647510232**

**647510280**

Deckenleuchte · Ceiling lamp

incl. SMD-LED  
45 W / 5.300 Lumen  
2.700 - 6.500 Kelvin

**647519231**

**647519232**

**647519280**

Metall, Acryl · metal, acryl



**31** | Weiß matt · white mat



**32** | Schwarz matt · black mat



**80** | Schwarz-Gold · black-gold





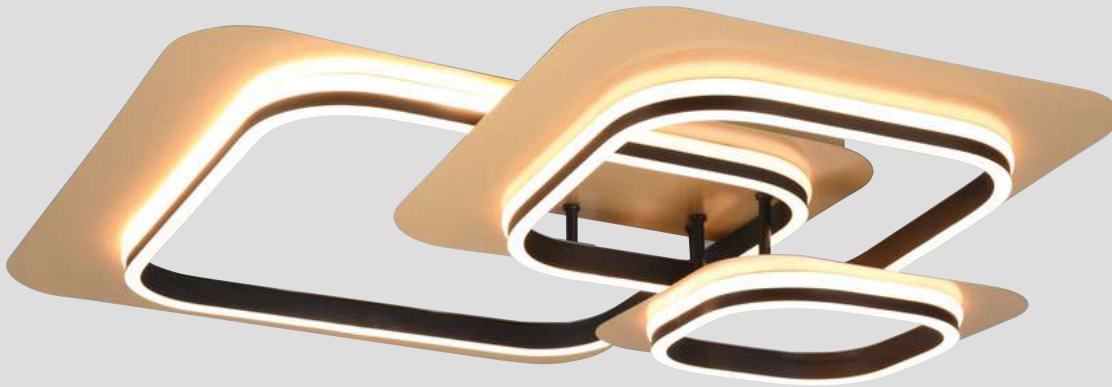
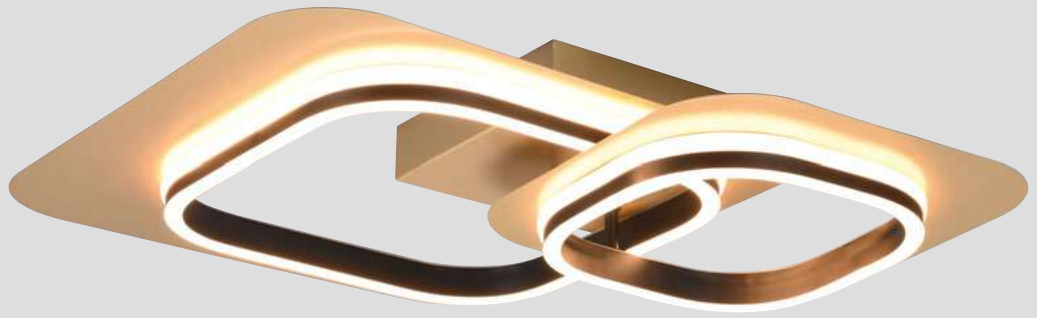

**SWITCH DIMMER**

Helligkeit in 3 Stufen mit herkömmlichem Lichtschalter einstellbar.

Brightness adjustable in 4 levels with conventional light switch.

Metall · metal



80 | Schwarz-Gold · black-gold

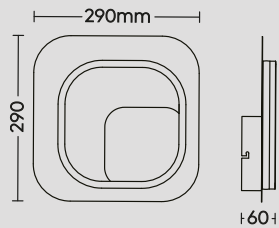

Wandleuchte · Wall lamp

incl. SMD-LED  
12 W / 1.450 Lumen  
3.000 Kelvin

242910180



IP20

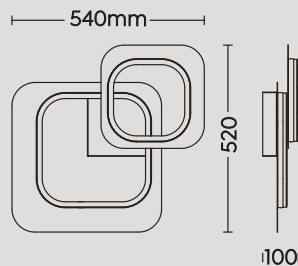

Deckenleuchte · Ceiling lamp

incl. SMD-LED  
28 W / 3.400 Lumen  
3.000 Kelvin

642910280



IP20

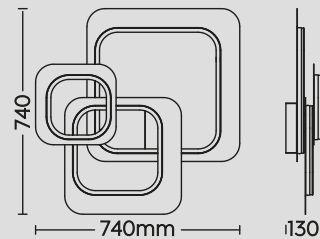

Deckenleuchte · Ceiling lamp

incl. SMD-LED  
50 W / 6.150 Lumen  
3.000 Kelvin

642910380



IP20

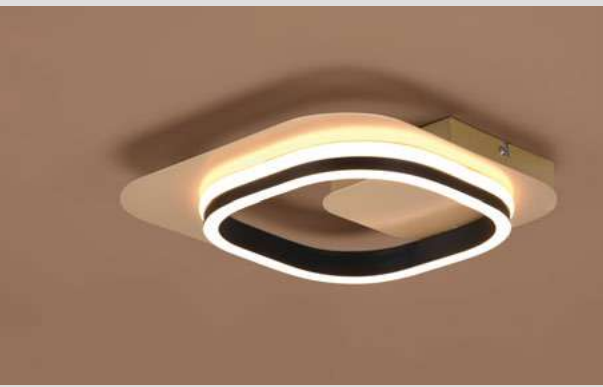

# LUGO

Die klaren Linien und symmetrischen Formen sorgen für eine ästhetische Balance, die in jedem Raum beeindruckt. Das harmonische Licht schafft eine angenehme und einladende Atmosphäre.

The clear lines and symmetrical shapes create an aesthetic balance that impresses in any room. The harmonious light creates a pleasant and inviting atmosphere.



# GRANADA

Diese stilvolle Leuchte sorgt für harmonisches und weiches Licht, das eine angenehme Atmosphäre in jedem Raum schafft. Erhältlich in den eleganten Farbkombinationen Weiß/Chrom oder Schwarz/Gold, fügt sich die Leuchte nahtlos in nahezu alle Einrichtungsstile ein.

This stylish light provides harmonious and soft light that creates a pleasant atmosphere in any room. Available in the elegant colour combinations of white/chrome or black/gold, the light blends seamlessly into almost any interior design style.



## SWITCH DIMMER

Helligkeit in 3 Stufen mit herkömmlichem Lichtschalter einstellbar.

Brightness adjustable in 4 levels with conventional light switch.



Metall · metal



**06** | Chrome / Weiß matt · chrome / white mat



**32** | Schwarz matt / goldfarbig · black mat / gold

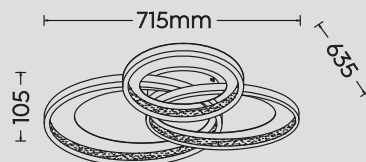
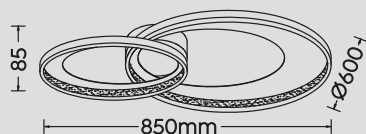
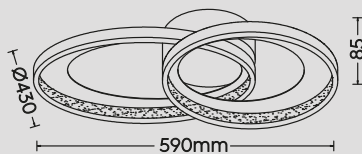

Deckenleuchte · Ceiling lamp

incl. SMD-LED  
29 W / 2.650 Lumen  
3.000 Kelvin

**673810206**  
**673810232**



IP20

Deckenleuchte · Ceiling lamp

incl. SMD-LED  
36 W / 3.250 Lumen  
3.000 Kelvin

**673890206**  
**673890232**



IP20

Deckenleuchte · Ceiling lamp

incl. SMD-LED  
36 W / 4.300 Lumen  
3.000 Kelvin

**673810306**  
**673810332**



IP20



# GALE

Das harmonische Design der Deckenleuchten GALE besticht durch seine geschwungene Formensprache.

The harmonious design of the GALE ceiling lights impresses with its curved design language.



## SWITCH DIMMER

Helligkeit in 3 Stufen mit herkömmlichem Lichtschalter einstellbar.

Brightness adjustable in 4 levels with conventional light switch.

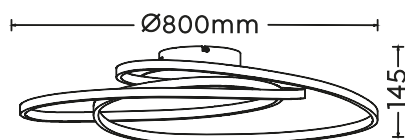
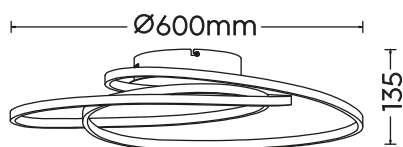

Deckenleuchte · Ceiling lamp

incl. SMD-LED  
38,5 W / 5.000 Lumen  
3.000 Kelvin

673916007

673916031

673916032



Deckenleuchte · Ceiling lamp

incl. SMD-LED  
50 W / 7.000 Lumen  
3.000 Kelvin

673918007

673918031

673918032



Metall · metal

07 | Nickel matt · nickel mat

31 | Weiß matt · white mat

32 | Schwarz matt · black mat





# MONTILLA

Ein einzigartiges Zusammenspiel aus Geradlinigkeit und Verspieltheit - Die klaren Linien werden durch verspielte Details ergänzt, wodurch der Leuchte eine besondere Note verliehen wird.

A unique interplay of straight lines and playfulness - the clear lines are complemented by playful details, giving the light a special touch.



Lichtfarbe stufenlos einstellbar ·  
Light color infinitely variable



Integrierter Dimmer ·  
Integrated dimmer



Memory Funktion ·  
Memory function

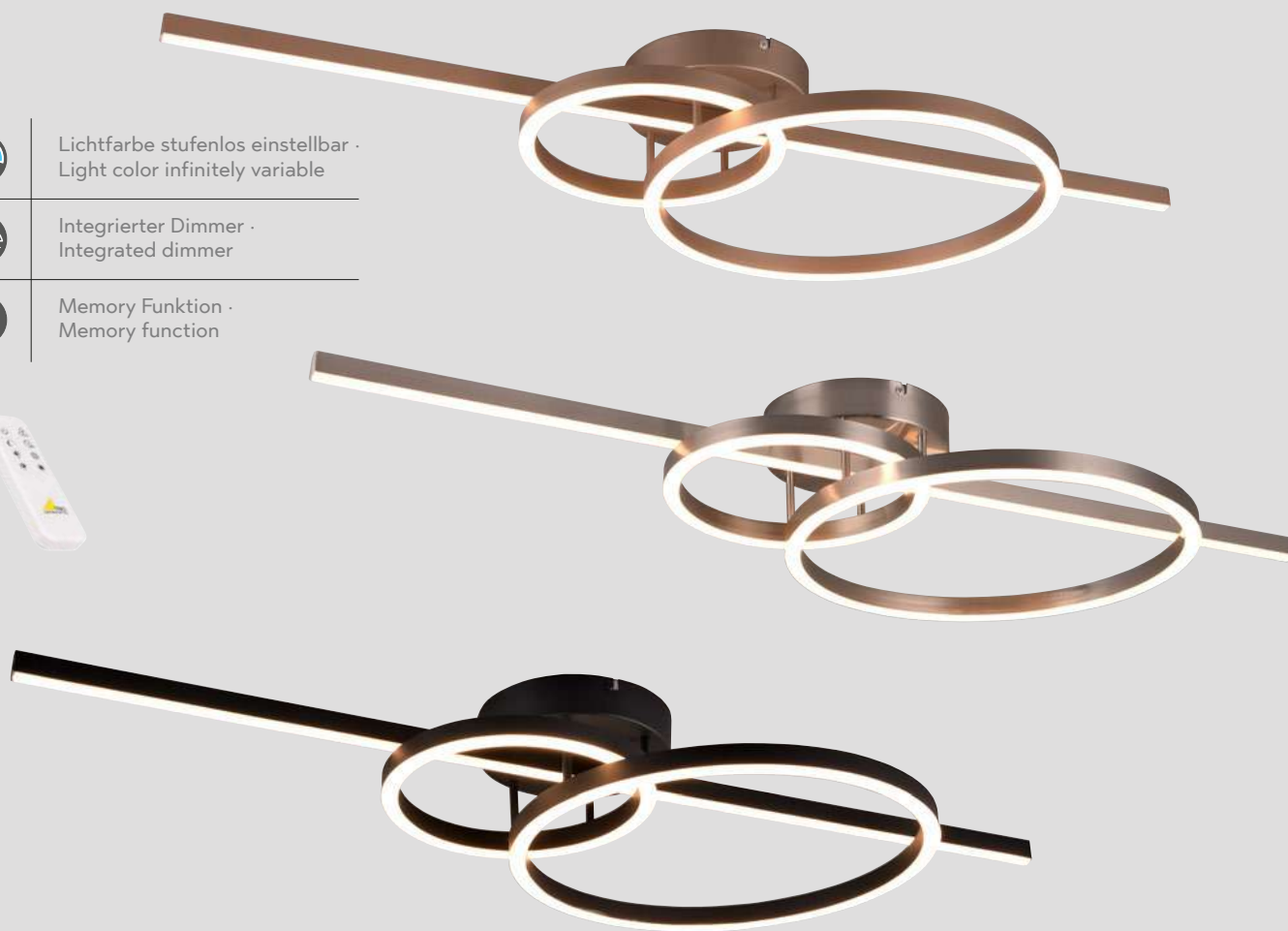

Metall, Acryl · metal, acryl



**06** | Chrome · chrome



**07** | Nickel matt · nickel mat



**32** | Schwarz matt · black mat



**65** | Coffee · coffee



**06** | Chrom, Acryl mit Kristalleffekt ·  
chrome, acryl with crystal effect

Deckenleuchte · Ceiling lamp

incl. SMD-LED

54 W / 6.300 Lumen

2.700 - 6.000 Kelvin

643010306

643010307

643010332

643010365

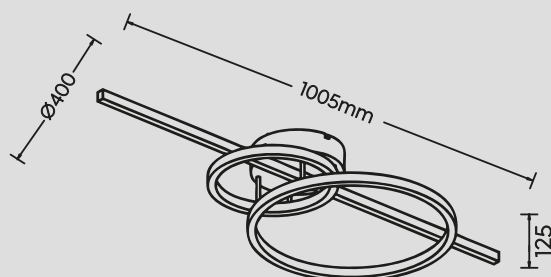

IP20





#### SWITCH DIMMER

Helligkeit in 3 Stufen mit herkömmlichem Lichtschalter einstellbar.

Brightness adjustable in 4 levels with conventional light switch.



Metall, Holz Weiß oder Schwarz · metal, wood white or black

32 | Schwarz matt · black mat

87 | titanfarbig · titan

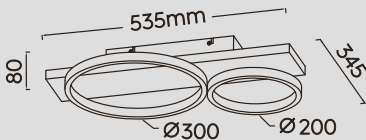

Deckenleuchte · Ceiling lamp

incl. SMD-LED  
26 W / 3.000 Lumen  
3.000 Kelvin

643810232  
643810287

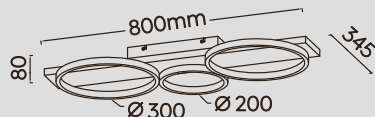

Deckenleuchte · Ceiling lamp

incl. SMD-LED  
33 W / 3.800 Lumen  
3.000 Kelvin

643810332  
643810387

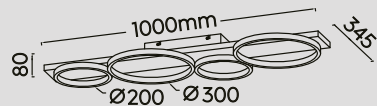

Deckenleuchte · Ceiling lamp

incl. SMD-LED  
44 W / 5.100 Lumen  
3.000 Kelvin

643810432  
643810487



# MEDERA

Die Deckenleuchten MEDERA überzeugen durch ihr modernes und aufregendes Design. Mit ihrem puristischen Stil und den geometrischen Formen sorgt sie für eine gleichmäßige Lichtverteilung über die gesamte Fläche. Diese innovative Gestaltung schafft eine harmonische und stilvolle Atmosphäre, die jeden Raum aufwertet.

The MEDERA ceiling lights impress with their modern and exciting design. With its purist style and geometric shapes, it ensures uniform light distribution over the entire surface. This innovative design creates a harmonious and stylish atmosphere that enhances any room.



# GROOVY

GROOVY lässt sich dank der Deko-Kristalle als echtes Schmuckstück für Wände und Decken bezeichnen.

GROOVY can be described as a real piece of jewellery for walls and ceilings thanks to the decorative crystals.



## SWITCH DIMMER

Helligkeit in 3 Stufen mit herkömmlichem Lichtschalter einstellbar.

Brightness adjustable in 4 levels with conventional light switch.

Metall, Kristallglas · metal, crystalglass



**31** | Weiß matt · white mat



**32** | Schwarz matt · black mat

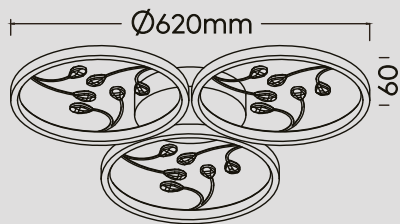

Deckenleuchte · Ceiling lamp

incl. SMD-LED  
30 W / 3.800 Lumen  
4.000 Kelvin

**642110331**



Deckenleuchte · Ceiling lamp

incl. SMD-LED  
30 W / 3.600 Lumen  
3.000 Kelvin

**642110332**

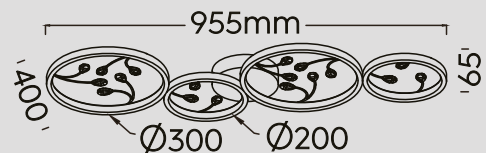

Deckenleuchte · Ceiling lamp

incl. SMD-LED  
37 W / 4.800 Lumen  
4.000 Kelvin

**642110431**



Deckenleuchte · Ceiling lamp

incl. SMD-LED  
37 W / 4.600 Lumen  
3.000 Kelvin

**642110432**





# CRYSTEL

Diese stilvolle Deckenleuchte besticht durch ihren rauchfarbenen Glasschirm. Im Inneren des Schirms sorgen kunstvolle Glasapplikationen für ein faszinierendes Lichtspiel.

This stylish ceiling light impresses with its smoke-coloured glass shade. Inside the shade, ornate glass applications create a fascinating play of light.



Glas chrom bedampft, Acryl ·  
chrome plated glass, acryl



06 | Chrome · chrome

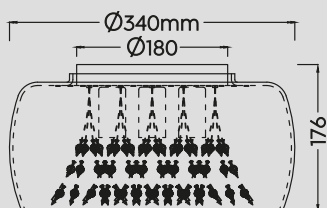

Deckenleuchte · Ceiling lamp

excl. 3 x E14  
max. 28 W

616700306



IP20

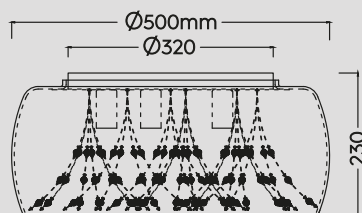

Deckenleuchte · Ceiling lamp

excl. 5 x E14  
max. 28 W

616700506



IP20





# IRVINE

IRVINE besticht durch ihre klaren Linien und fungiert als strahlendes Designobjekt, das jeden Raum mit seiner modernen Ästhetik bereichert.

IRVINE impresses with its clear lines and functions as a radiant design object that enriches any room with its modern aesthetics.



Lichtfarbe stufenlos einstellbar ·  
Light color infinitely variable



Integrierter Dimmer ·  
Integrated dimmer



Memory Funktion ·  
Memory function

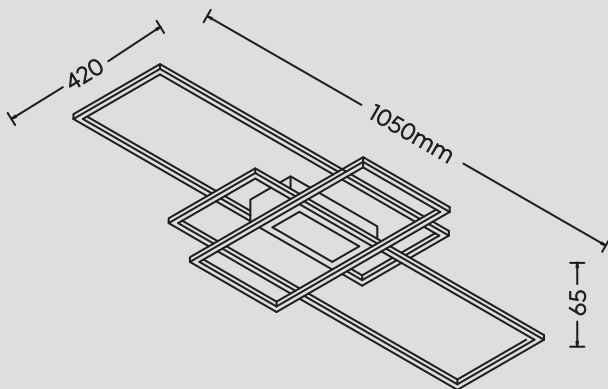
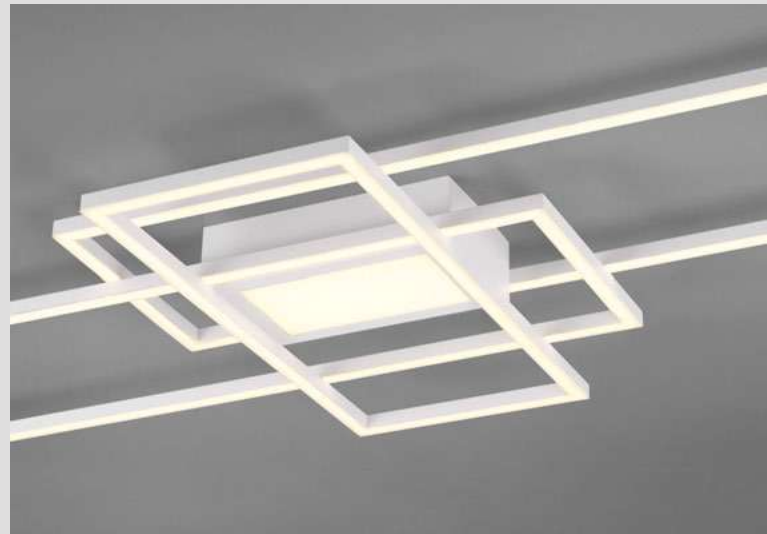
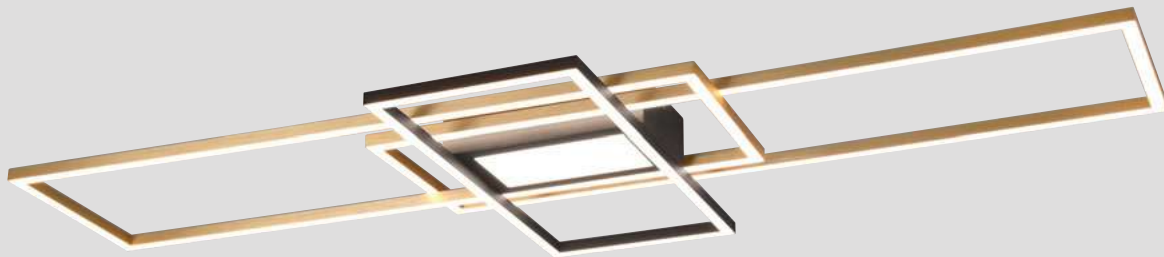
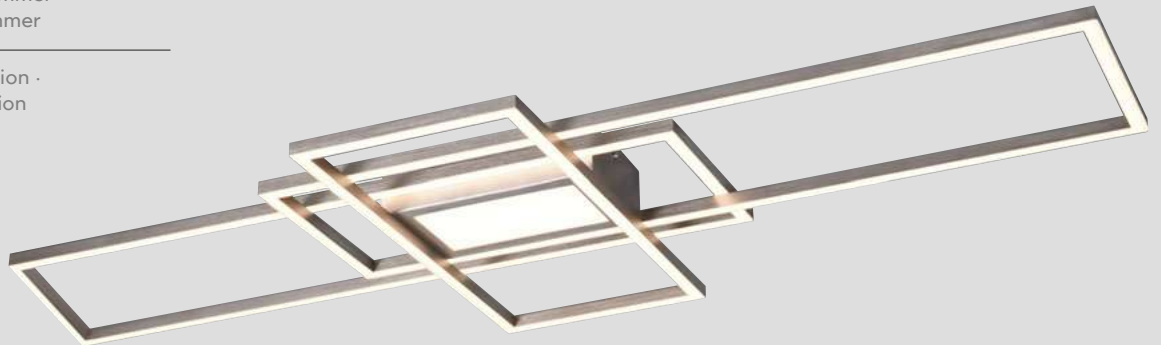

Deckenleuchte · Ceiling lamp

incl. SMD-LED  
60 W / 7.100 Lumen  
3.000 - 6.500 Kelvin

620010407

620010408

620010431

620010442

Metall · metal



07 | Nickel matt · nickel mat



08 | Messing matt · brass mat



31 | Weiß matt · white mat



42 | Anthrazit · anthracite



IP20



# DOWNEY



Lichtfarbe stufenlos einstellbar ·  
Light color infinitely variable



Integrierter Dimmer ·  
Integrated dimmer



Memory Funktion ·  
Memory function



Metall, Acryl · metal, acryl

07 | Nickel matt · nickel mat

31 | Weiß matt · white mat

32 | Schwarz matt · black mat

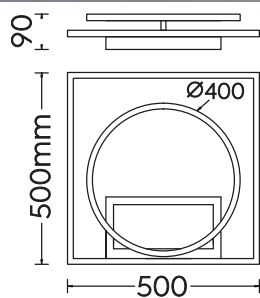

Deckenleuchte · Ceiling lamp

incl. SMD-LED

33 W / 4.600 Lumen

2.700 - 6.500 Kelvin

620510307

620510331

620510332





Lichtfarbe stufenlos einstellbar ·  
Light color infinitely variable



Integrierter Dimmer ·  
Integrated dimmer



Metall, Acryl · metal, acryl



32 | Schwarz matt · black mat

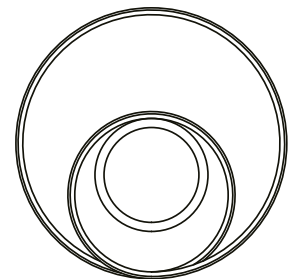

Ø600mm



70

Deckenleuchte · Ceiling lamp  
incl. SMD-LED  
56 W / 6.800 Lumen  
2.700 - 6.000 Kelvin  
672310232



# HYDRA

Diese Leuchte besticht durch ihre klare geometrische Formensprache, die moderne Eleganz und das zeitlose Design. Die harmonische Ausleuchtung sorgt für eine gleichmäßige und angenehme Lichtverteilung.

This luminaire impresses with its clear geometric design language, modern elegance and timeless design. The harmonious illumination ensures uniform and pleasant light distribution.

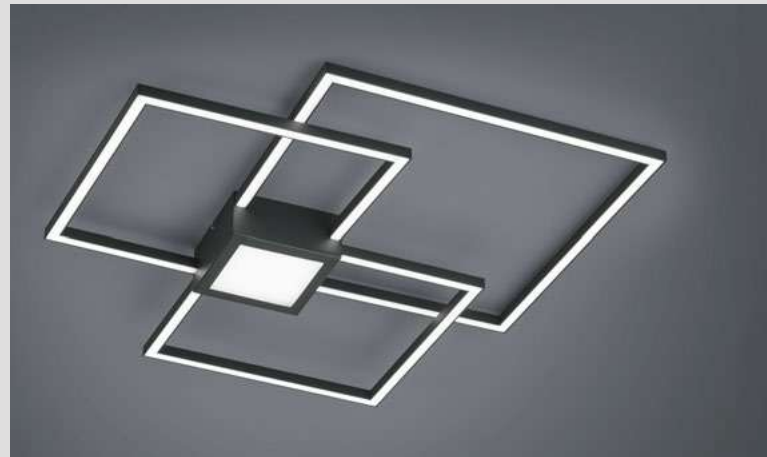
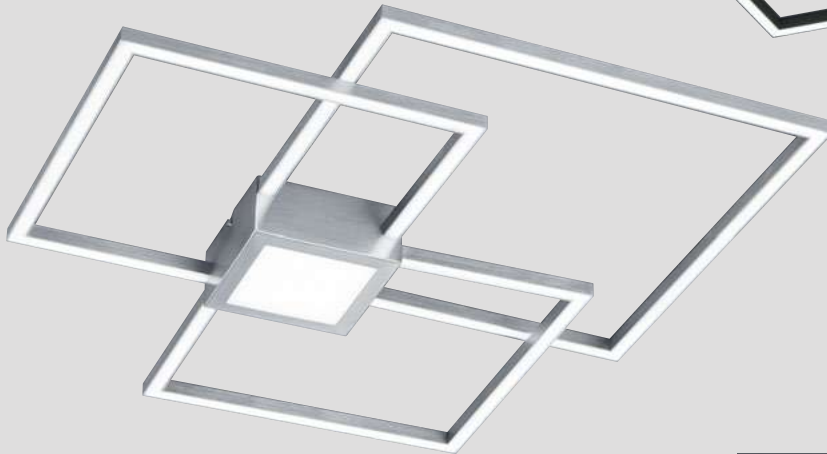
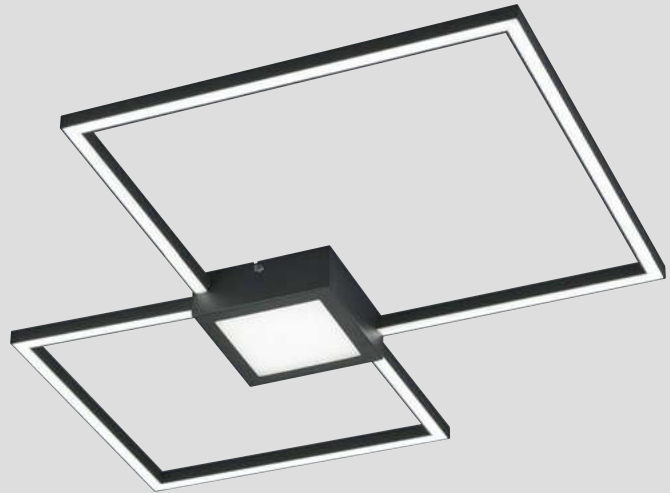

## SWITCH DIMMER

Helligkeit in 3 Stufen mit herkömmlichem Lichtschalter einstellbar.

Brightness adjustable in 4 levels with conventional light switch.

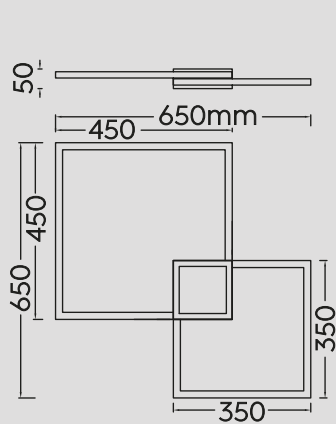

Deckenleuchte · Ceiling lamp

incl. SMD-LED  
28 W / 2.600 Lumen  
3.000 Kelvin  
**676210307**  
**676210342**

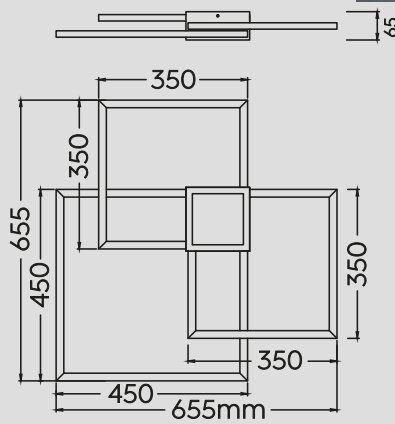

Deckenleuchte · Ceiling lamp

incl. SMD-LED  
38 W / 4.400 Lumen  
3.000 Kelvin  
**676210407**  
**676210442**



Metall · metal

07 | Nickel matt · nickel mat

31 | Weiß matt · white mat

42 | Anthrazit · anthracite

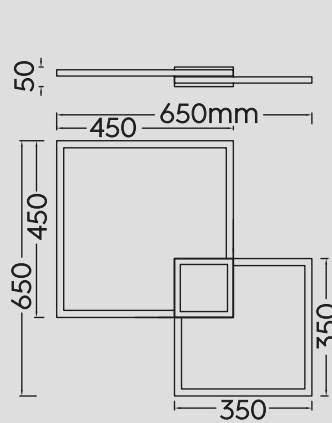

Deckenleuchte · Ceiling lamp  
incl. SMD-LED  
28 W / 3.200 Lumen  
4.000 Kelvin  
**676240331**

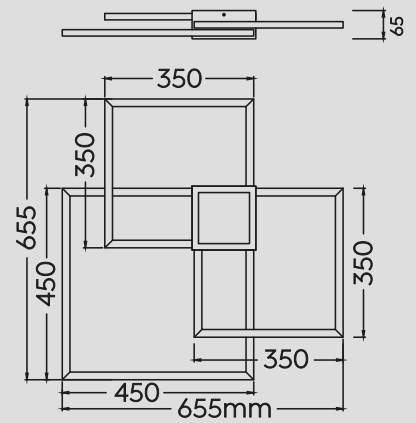

Deckenleuchte · Ceiling lamp  
incl. SMD-LED  
38 W / 4.400 Lumen  
4.000 Kelvin  
**676240431**





# COOKIE

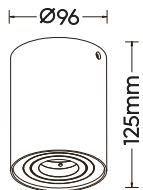

Deckenleuchte · Ceiling lamp

excl. 1 x GU10  
max. 35 W

612900131  
612900132  
612900134  
612900180

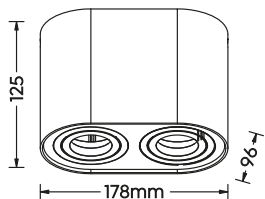

Deckenleuchte · Ceiling lamp

excl. 2 x GU10  
max. 35 W

612900231  
612900232



Metall · metal



31 | Weiß matt · white mat



32 | Schwarz matt · black mat



34 | Schwarz-Weiß · black and white



80 | Schwarz-Gold · black-gold



# BISCUIT

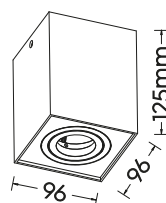

Deckenleuchte · Ceiling lamp

excl. 1 x GU10  
max. 35 W

**613000131**  
**613000132**  
**613000134**  
**613000180**

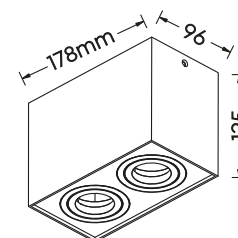





Deckenleuchte · Ceiling lamp

excl. 2 x GU10  
max. 35 W

**613000231**  
**613000232**



Metall · metal

-  **31** | Weiß matt · white mat
-  **32** | Schwarz matt · black mat
-  **34** | Schwarz-Weiß · black and white
-  **80** | Schwarz-Gold · black-gold



# FERNANDO

FERNANDO im kubistischen Würfel-Design bringt moderne, minimalistische Ästhetik in Ihren Raum und überzeugt durch klare Linien und eine markante Formensprache.

FERNANDO in cubist cube design brings modern, minimalist aesthetics into your room and impresses with its clear lines and striking design language.



Metall · metal

○ 31 | Weiß matt · white mat

● 32 | Schwarz matt · black mat



Empfohlen:  
recommended:

LED GU10  
4,5 W / 345 Lumen  
3.000 Kelvin  
**956-5936**

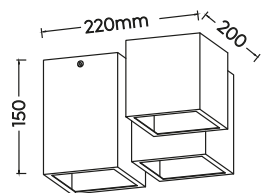

Deckenleuchte · Ceiling lamp

excl. 3 x GU10  
max. 35 W

604900331  
604900332

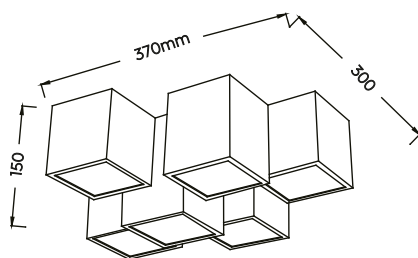

Deckenleuchte · Ceiling lamp

excl. 6 x GU10  
max. 35 W

604900631  
604900632



# SORRENTO

Metall · metal

32 | Schwarz matt · black mat



## SWITCH DIMMER

Helligkeit in 3 Stufen mit herkömmlichem Lichtschalter einstellbar.

Brightness adjustable in 4 levels with conventional light switch.

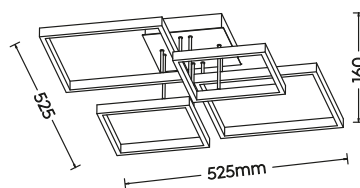

Deckenleuchte · Ceiling lamp  
incl. SMD-LED  
24 W / 2.800 Lumen  
3.000 Kelvin  
**627710432**

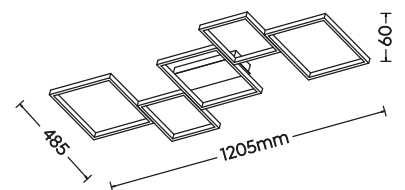

Deckenleuchte · Ceiling lamp  
incl. SMD-LED  
34 W / 4.500 Lumen  
3.000 Kelvin  
**627710532**



# SEDONA

Metall, Holznachbildung ·  
metal, wood imitation

● 32 | Schwarz matt · black mat



## SWITCH DIMMER

Helligkeit in 3 Stufen mit  
herkömmlichem Lichtschalter  
einstellbar.

Brightness adjustable in 4 levels  
with conventional light switch.



Deckenleuchte · Ceiling lamp

incl. SMD-LED  
40 W / 4.800 Lumen  
3.000 Kelvin

673210332

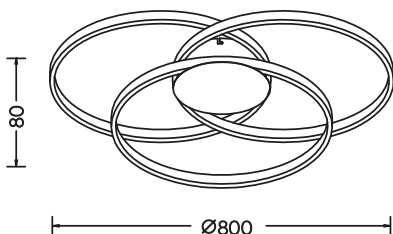

IP20

# TUCSON

Metall, Holznachbildung ·  
metal, wood imitation

● 32 | Schwarz matt · black mat



## SWITCH DIMMER

Helligkeit in 3 Stufen mit  
herkömmlichem Lichtschalter  
einstellbar.

Brightness adjustable in 4 levels  
with conventional light switch.



Deckenleuchte · Ceiling lamp

incl. SMD-LED  
35 W / 4.400 Lumen  
3.000 Kelvin

672610332

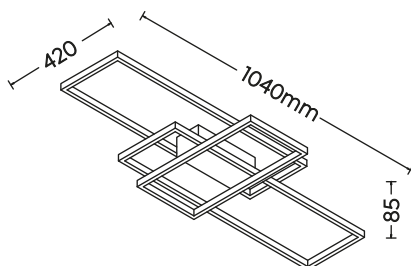

IP20



# THIAGO

Sicherheit durch Licht - Die smarte Deckenleuchte THIAGO kann das Heim per App bereits von unterwegs viel lebendiger erscheinen lassen.

Safety through light - The THIAGO smart ceiling light can make your home appear much livelier when you're on the move using an app.



RGBW Farbwechsler · RGBW Colorchanging



Lichtfarbe stufenlos einstellbar · Light color infinitely variable



Memory Funktion · Memory function

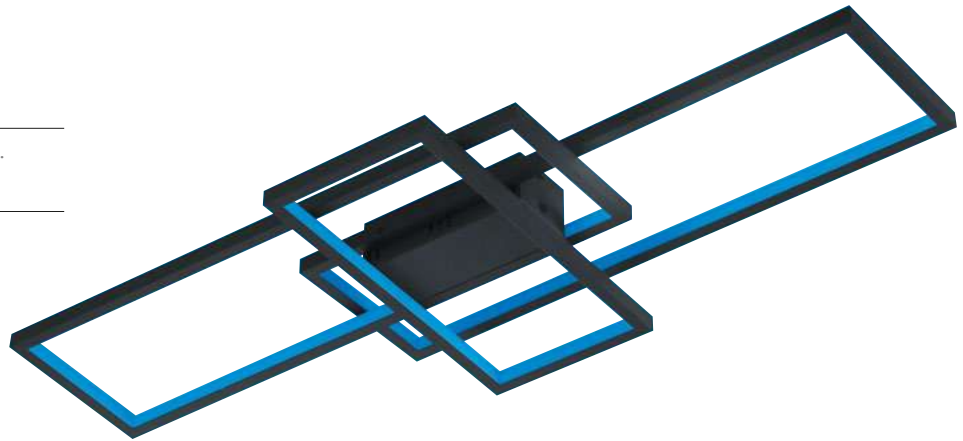

Metall · metal



42 | Anthrazit · anthracite

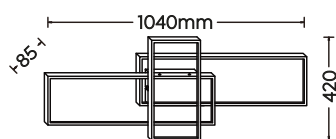
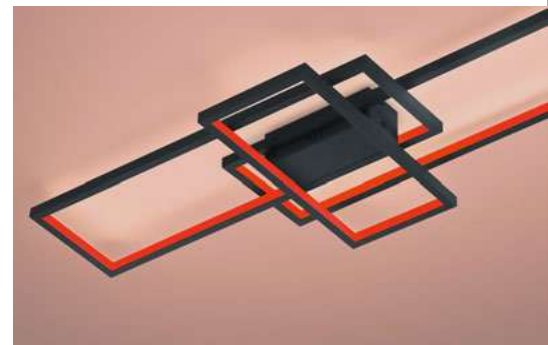
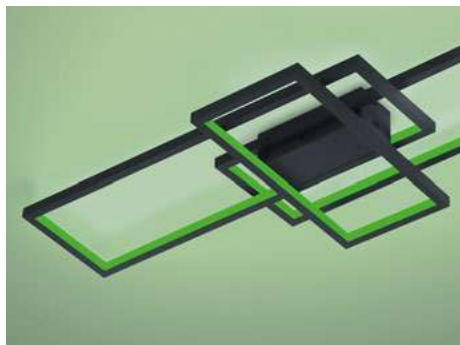
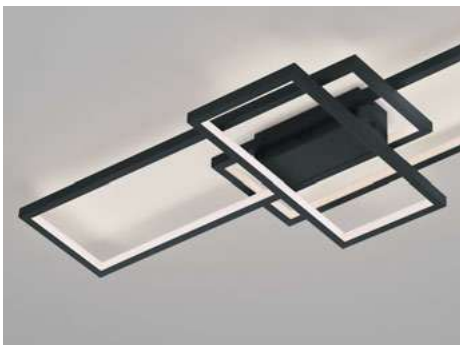

Deckenleuchte · Ceiling lamp  
incl. RGBW-LED  
36 W / 3.000 Lumen  
3.000 - 6.000 Kelvin  
652610342

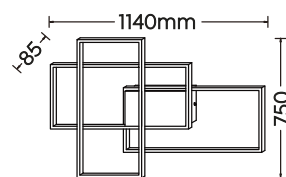

Deckenleuchte · Ceiling lamp  
incl. RGBW-LED  
39 W / 4.500 Lumen  
3.000 - 6.000 Kelvin  
652690342



64.000 **WEISSTÖNE**  
64,000 **WHITES**



Einstellbare Lichtprogramme · Preset light modes



16 Millionen **FARBEN**  
16 million **COLORS**



Dynamische Lichtprogramme · Dynamic light modes





# WINONA



RGBW Farbwechsler ·  
RGBW Colorchanging



Lichtfarbe stufenlos einstellbar ·  
Light color infinitely variable



Getrennt schaltbar ·  
Separately switchable



indirekte Beleuchtung ·  
indirect lighting



Deckenleuchte · Ceiling lamp

incl. SMD-LED  
28 W / 3.200 Lumen  
2.700 - 6.500 Kelvin  
incl. RGB-LED  
10 W

670810607

670810632

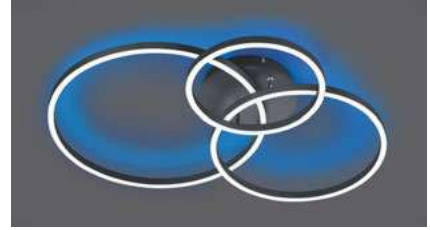
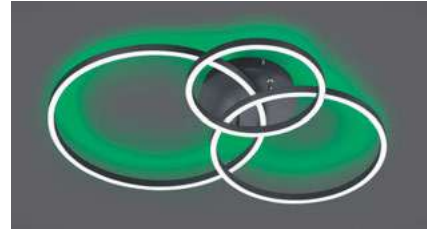
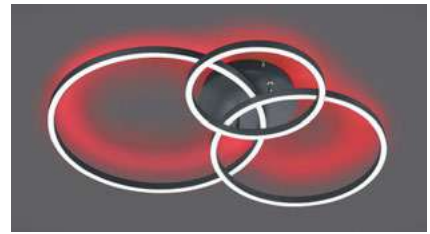
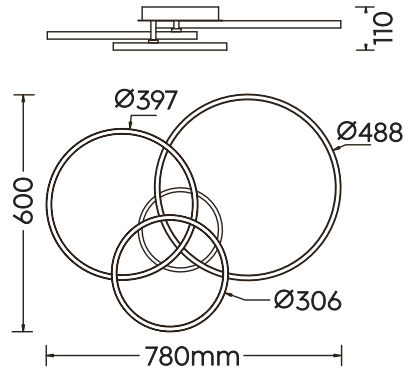

Metall · metal



07 | Nickel matt · nickel mat



32 | Schwarz matt · black mat

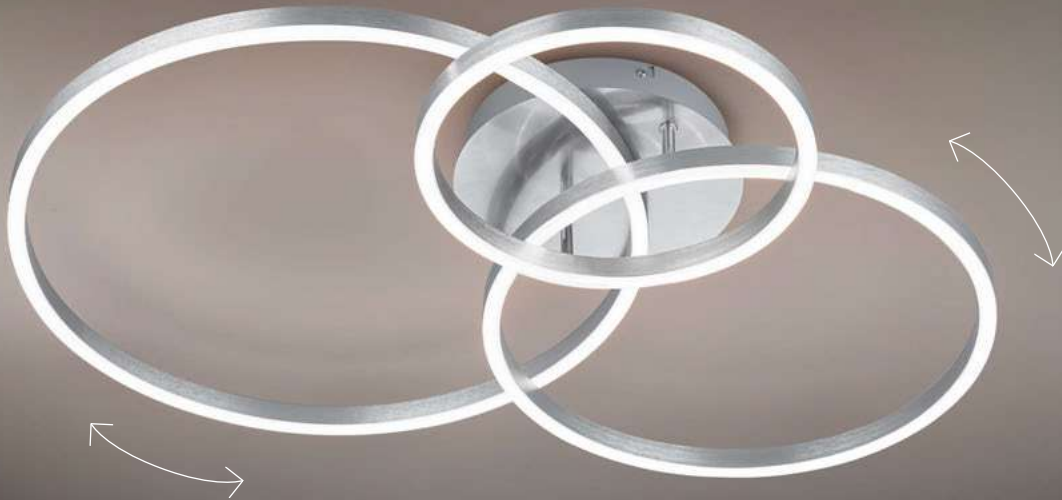



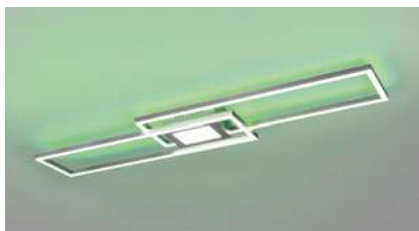

Metall · metal

07 | Nickel matt · nickel mat

32 | Schwarz matt · black mat



RGBW Farbwechsler ·  
RGBW Colorchanging



Lichtfarbe stufenlos einstellbar ·  
Light color infinitely variable



Getrennt schaltbar ·  
Separately switchable



indirekte Beleuchtung ·  
indirect lighting

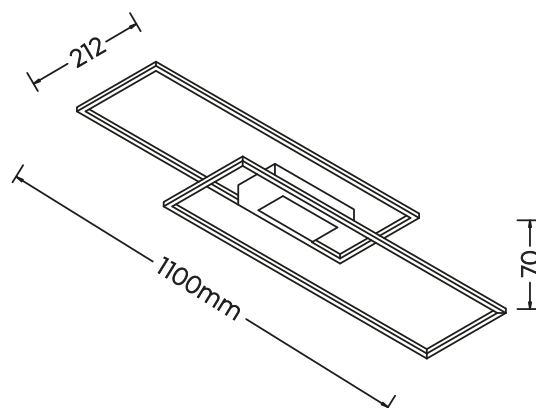

Deckenleuchte · Ceiling lamp

incl. SMD-LED  
37 W / 4.300 Lumen

2.700 - 6.500 Kelvin

incl. RGB-LED

8 W

670710507

670710532



IP20

# ARVIN

Diese moderne LED-Deckenleuchte verspricht vielseitige Einsatzmöglichkeiten. Die verstellbaren Elemente ermöglichen es, das Licht gezielt auszurichten und so verschiedene Bereiche des Raumes optimal zu beleuchten. Die Funktion für indirektes Licht in RGB setzt zusätzlich farbige Akzente.

This modern LED ceiling light promises a wide range of applications. The adjustable elements make it possible to direct the light in a targeted manner and thus optimally illuminate different areas of the room. The indirect light function in RGB sets additional colourful accents.



RGBW Farbwechsler ·  
RGBW Colorchanging



Lichtfarbe stufenlos einstellbar ·  
Light color infinitely variable



Getrennt schaltbar ·  
Separately switchable



Integrierter Dimmer ·  
Integrated dimmer



Metall · metal

07 | Nickel matt · nickel mat

32 | Schwarz matt · black mat

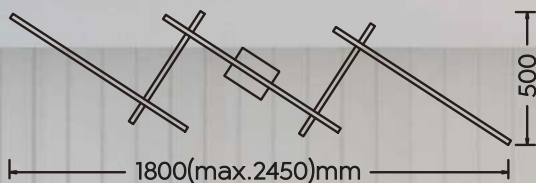
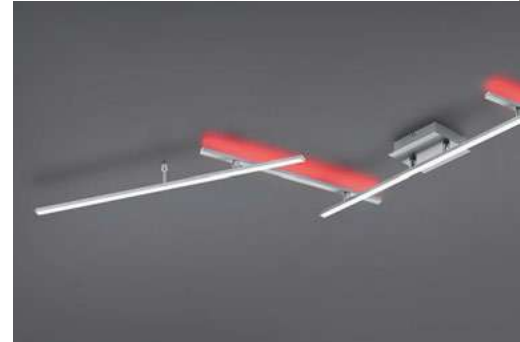
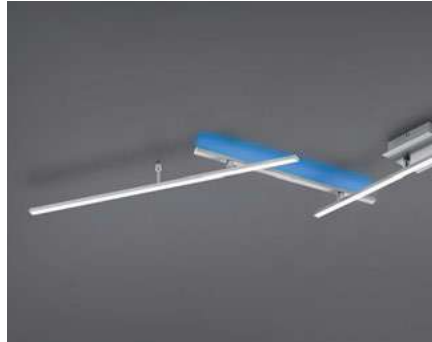

Deckenleuchte · Ceiling lamp

incl. SMD-LED  
22 W / 2.600 Lumen

2.700 - 6.500 Kelvin

incl. RGB-LED  
8 W

628410507

628410532



# MELBY

Die Kombination aus modernem Design und innovativer Technik macht MELBY zu einer idealen Wahl für jedes Zuhause. Sie überzeugt nicht nur durch ihre Funktionalität, sondern auch durch ihre intelligente Steuerung. Dank der smarten Technologie kann sie bequem per App bedient werden, wodurch eine flexible und komfortable Nutzung ermöglicht wird.

The combination of modern design and innovative technology makes MELBY an ideal choice for any home. It not only impresses with its functionality, but also with its intelligent control. Thanks to the smart technology, it can be conveniently operated via app, enabling flexible and convenient use.



**SMART LIGHTING** | **WIZ CONNECTED**



RGBW Farbwechsler · RGBW Colorchanging



Lichtfarbe stufenlos einstellbar · Light color infinitely variable

Metall · metal



**07** | Nickel matt · nickel mat

64.000 **WEISSTÖNE**  
64,000 **WHITES**



Einstellbare Lichtprogramme · Preset light modes



16 Millionen **FARBEN**  
16 million **COLORS**



Dynamische Lichtprogramme · Dynamic light modes

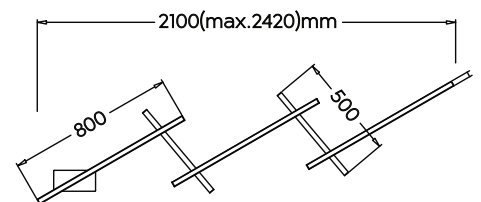

Deckenleuchte · Ceiling lamp  
incl. RGBW-LED  
23 W / max. 2.200 Lumen  
3.000 - 5.000 Kelvin  
**651210507**



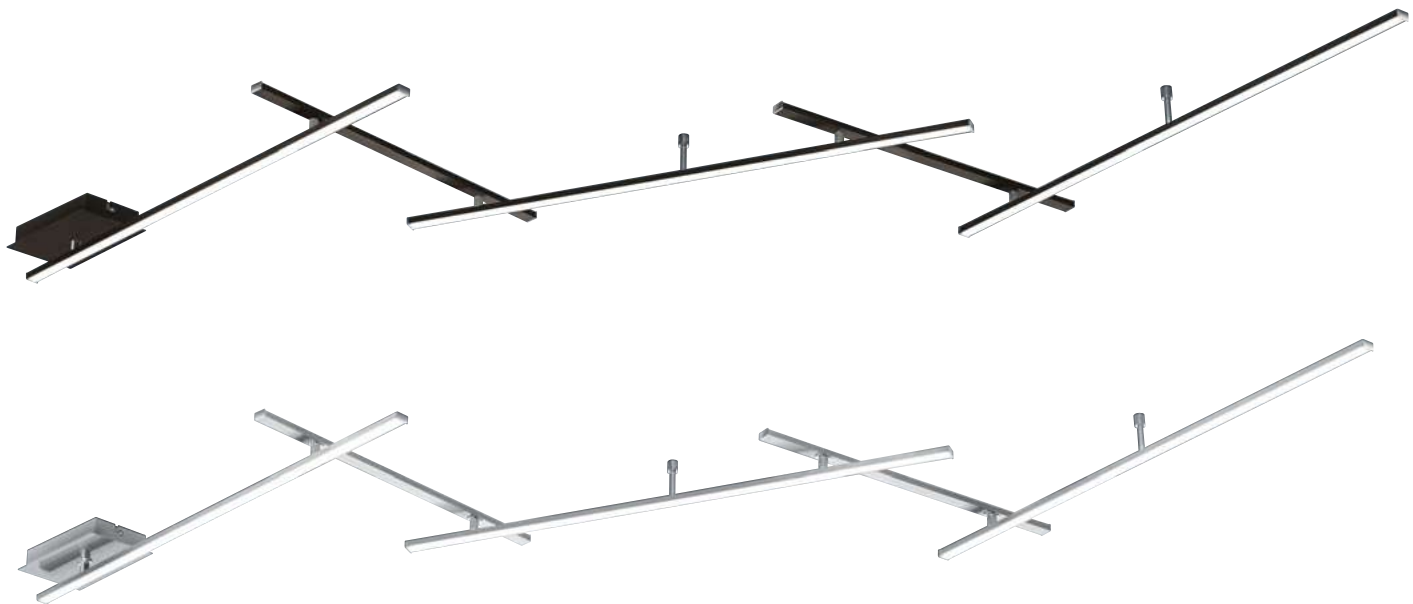

**SWITCH DIMMER**

Helligkeit in 3 Stufen mit  
herkömmlichem Lichtschalter  
einstellbar.

Brightness adjustable in 4 levels  
with conventional light switch.

Metall, Acryl · metal, acryl



**07** | Nickel matt · nickel mat



**32** | Schwarz matt · black mat



Gibt Licht nach oben und unten · up and down lighting

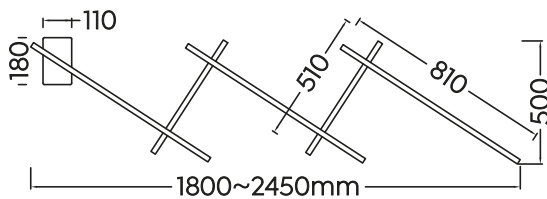
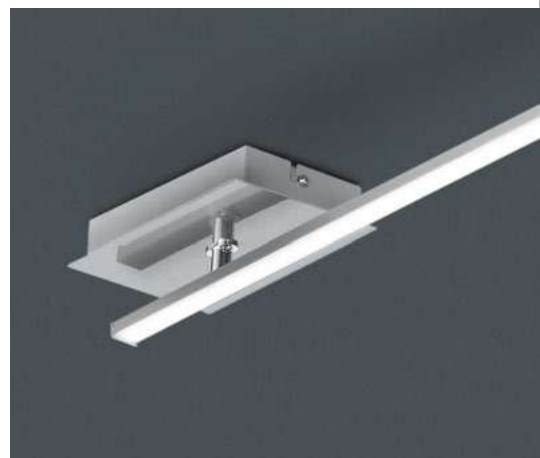

Deckenleuchte · Ceiling lamp

incl. SMD-LED  
25 W / 3.000 Lumen  
3.000 Kelvin

**674610507**

**674610532**

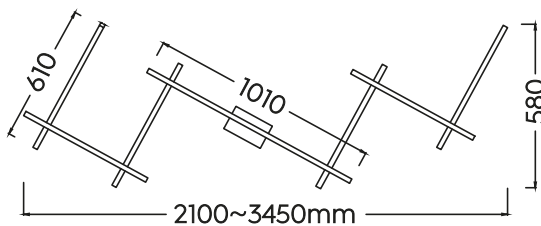

Deckenleuchte · Ceiling lamp

incl. SMD-LED  
28 W / 3.500 Lumen  
3.000 Kelvin

**674610707**



# INDIRA

Die schmalen Elemente und das lineare Design bieten eine puristische Ästhetik, die modernen Räumen eine elegante und dezente Beleuchtung verleiht.

The narrow elements and linear design offer a purist aesthetic that lends modern rooms elegant and discreet lighting.



# TIRIAC

Mit ihrem linearen Design und den drei schwenkbaren Elementen bietet diese Leuchte eine moderne und flexible Beleuchtungslösung für jeden Raum.

With its linear design and three swivelling elements, this luminaire offers a modern and flexible lighting solution for any room.



Metall · metal



07 | Nickel matt · nickel mat

Deckenleuchte · Ceiling lamp

incl. SMD-LED  
3 x 9 W / 3 x 950 Lumen  
3.000 Kelvin

671610307

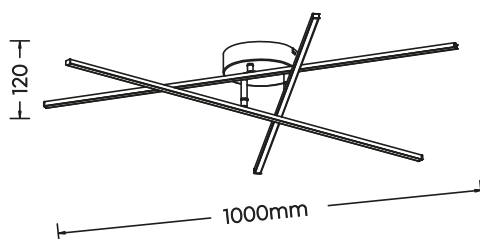

## SWITCH DIMMER

Helligkeit in 3 Stufen mit herkömmlichem Lichtschalter einstellbar.

Brightness adjustable in 4 levels with conventional light switch.



#### SWITCH DIMMER

Helligkeit in 3 Stufen mit herkömmlichem Lichtschalter einstellbar.

Brightness adjustable in 4 levels with conventional light switch.

## OXFORD

Reduzierte Formensprache und ein schlichtes Weiß erzeugen eine zeitlose und aufgeräumte Atmosphäre.

Reduced design language and plain white create a timeless and uncluttered atmosphere.

Metall · metal



31 | Weiß matt · white mat

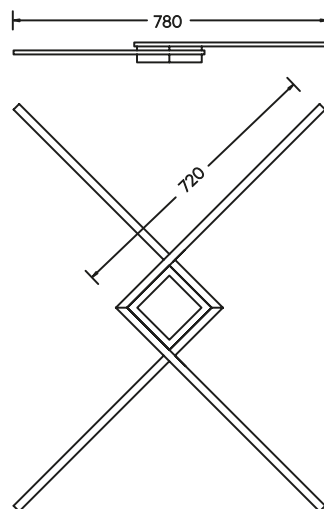

1020mm

Deckenleuchte · Ceiling lamp  
incl. SMD-LED  
27 W / 3.600 Lumen  
4.000 Kelvin  
**674410331**



IP20

# BULLET



## SWITCH DIMMER

Helligkeit in 3 Stufen mit herkömmlichem Lichtschalter einstellbar.

Brightness adjustable in 4 levels with conventional light switch.

Metall · metal



07 | Nickel matt · nickel mat



Deckenleuchte · Ceiling lamp

incl. SMD-LED

21 x 1,5 W / 21 x 170 Lumen

3.000 Kelvin

641412107

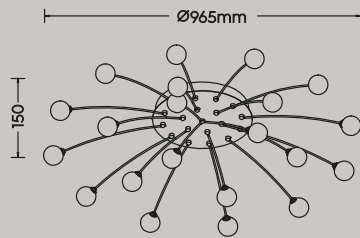

# PEACOCK



## SWITCH DIMMER

Helligkeit in 3 Stufen mit herkömmlichem Lichtschalter einstellbar.

Brightness adjustable in 4 levels with conventional light switch.

Metall · metal



32 | Schwarz matt · black mat

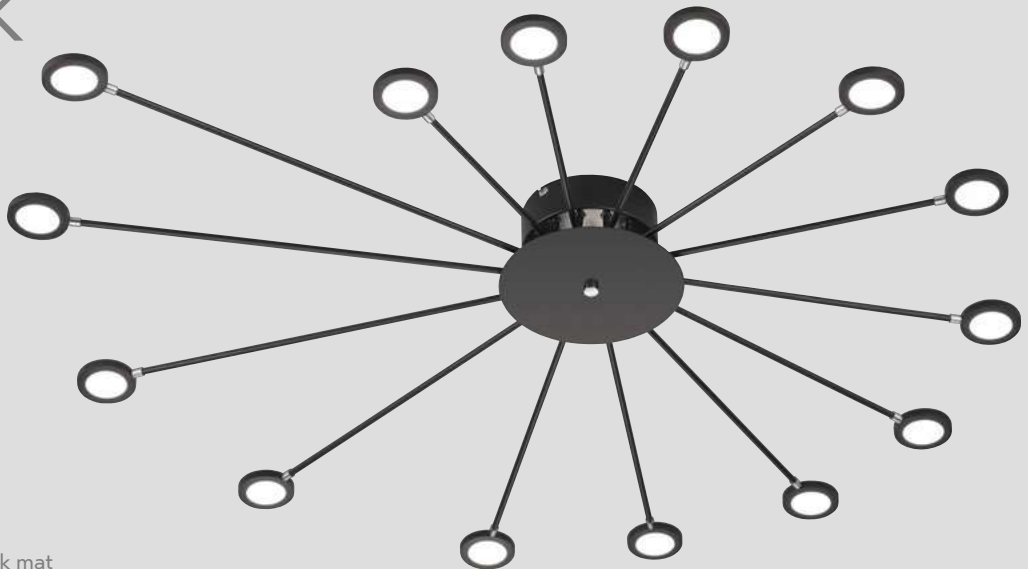

Deckenleuchte · Ceiling lamp

incl. SMD-LED

15 x 2,6 W / 15 x 270 Lumen

3.000 Kelvin

679511532

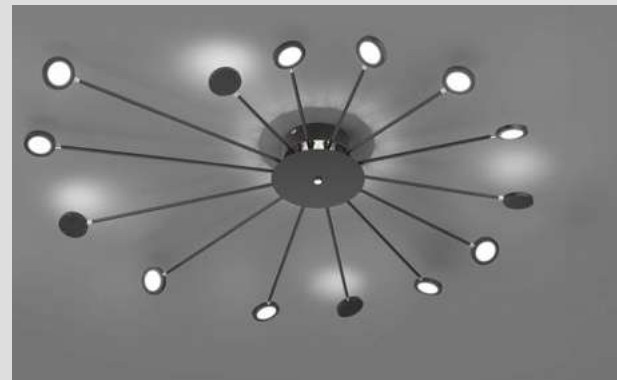
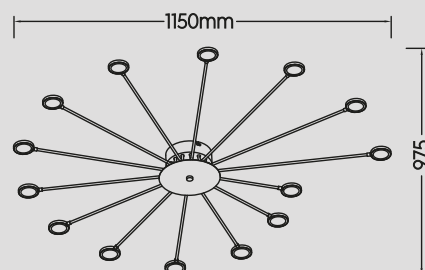



# BODRUM



Lichtfarbe stufenlos einstellbar ·  
Light color infinitely variable



Integrierter Dimmer ·  
Integrated dimmer



Memory Funktion ·  
Memory function



Metall · metal



06 | Chrome · chrome

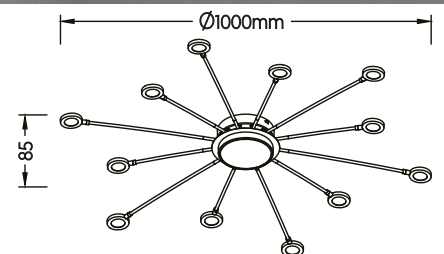

Deckenleuchte · Ceiling lamp

incl. SMD-LED  
12 x 2,2 W / 12 x 250 Lumen  
3.000 - 6.500 Kelvin  
incl. SMD-LED  
5 W / 550 Lumen  
3.000 - 6.500 Kelvin  
**673311306**



IP20

# LUGANO

Eine gelungene Kombination aus Eleganz und Schlichtheit - Der Textilschirm sorgt dafür, dass das Licht sanft gestreut wird und keine harten Schatten entstehen. Dies schafft eine warme und einladende Atmosphäre für Wohnräume und Schlafzimmer.

A successful combination of elegance and simplicity - the textile shade ensures that the light is gently diffused and no harsh shadows are created. This creates a warm and inviting atmosphere for living rooms and bedrooms.



## SWITCH DIMMER

Helligkeit in 3 Stufen mit herkömmlichem Lichtschalter einstellbar.

Brightness adjustable in 4 levels with conventional light switch.

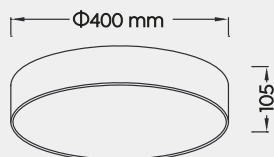

Deckenleuchte · Ceiling lamp

incl. SMD-LED  
22 W / 2.500 Lumen  
3.000 Kelvin  
**621912401**  
**621912411**

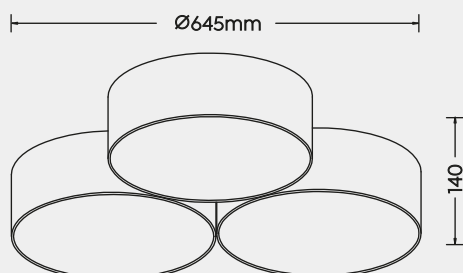

Deckenleuchte · Ceiling lamp

incl. SMD-LED  
38 W / 4.200 Lumen  
3.000 Kelvin  
**621910317**



Stoffschirm, Acryl · fabric shade, acryl

-  **01** | Weiß · white
-  **11** | Grau · grey
-  **17** | mehrfarbig · multicolor



Lichtfarbe stufenlos einstellbar ·  
Light color infinitely variable



Integrierter Dimmer ·  
Integrated dimmer



Memory Funktion ·  
Memory function



Nachtlicht ·  
Night light

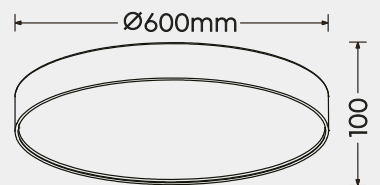

Deckenleuchte · Ceiling lamp  
incl. SMD-LED  
42 W / 4.900 Lumen  
3.000 - 5.000 Kelvin  
**621914001**  
**621914011**



# YUMA NEW

Die Deckenleuchte YUMA beeindruckt mit einem Durchmesser von 100 cm und exzellenter Lichtqualität. Diese großzügige Ausführung sorgt für eine gleichmäßige und helle Ausleuchtung großer Räume. Die kleineren Ausführungen sind zusätzlich mit indirekter RGB-Beleuchtung ausgestattet.

The YUMA ceiling light impresses with a diameter of 100 cm and excellent light quality. This generous design provides uniform and bright illumination for large rooms. The smaller versions are also equipped with indirect RGB lighting.

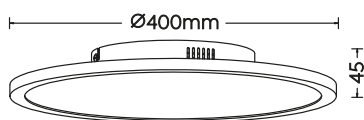

## Deckenleuchte · Ceiling lamp

incl. SMD-LED  
20 W / 2.250 Lumen  
3.000 - 6.500 Kelvin  
incl. RGB-LED  
3 W

641710287

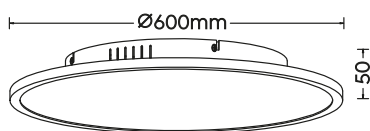

## Deckenleuchte · Ceiling lamp

incl. SMD-LED  
35 W / 4.200 Lumen  
3.000 - 6.500 Kelvin  
incl. RGB-LED  
4 W

641719287



Lichtfarbe stufenlos einstellbar ·  
Light color infinitely variable



RGB Farbwechsler ·  
RGB Colorchanging



Integrierter Dimmer ·  
Integrated dimmer



Getrennt schaltbar ·  
Separately switchable



Memory Funktion ·  
Memory function



Metall · metal  
**87** | titanfarbig · titan



Lichtfarbe stufenlos einstellbar ·  
 Light color infinitely variable



Sleep-Timer ·  
 Sleep timer



Memory Funktion ·  
 Memory function

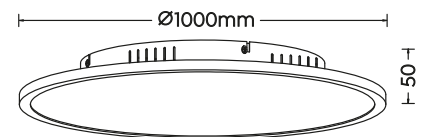

Deckenleuchte · Ceiling lamp  
 incl. SMD-LED  
 53 W / 6.700 Lumen  
 3.000 - 6.500 Kelvin  
**641719187**



# PHOENIX

Schlichte Lichtquellen, ganz ohne Schnickschnack, bieten eine klare und zurückhaltende Beleuchtungslösung, die sich nahtlos in jede Einrichtung einfügt.

Simple light sources, without any frills, offer a clear and unobtrusive lighting solution that blends seamlessly into any interior.

Metall, Acryl · metal, acryl



07 | Nickel matt · nickel mat

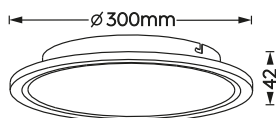

Deckenleuchte · Ceiling lamp  
incl. SMD-LED  
15 W / 1.700 Lumen  
3.000 Kelvin  
674093007

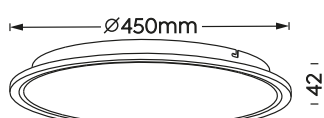

Deckenleuchte · Ceiling lamp  
incl. SMD-LED  
26 W / 3.000 Lumen  
3.000 Kelvin  
674094507

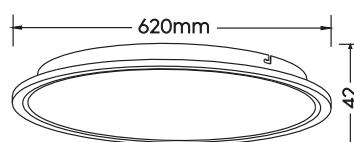

Deckenleuchte · Ceiling lamp  
incl. SMD-LED  
31 W / 3.600 Lumen  
3.000 Kelvin  
674096207

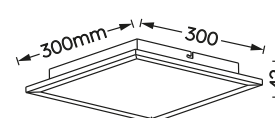

Deckenleuchte · Ceiling lamp  
incl. SMD-LED  
15 W / 1.700 Lumen  
3.000 Kelvin  
674013007



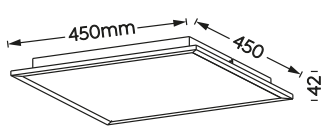

Deckenleuchte · Ceiling lamp  
incl. SMD-LED  
26 W / 3.000 Lumen  
3.000 Kelvin  
**674014507**

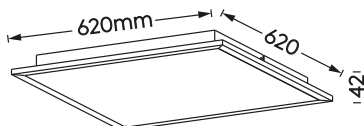

Deckenleuchte · Ceiling lamp  
incl. SMD-LED  
31 W / 3.600 Lumen  
3.000 Kelvin  
**674016207**

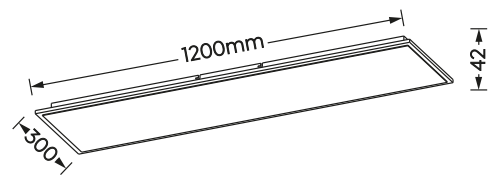

Deckenleuchte · Ceiling lamp  
incl. SMD-LED  
31 W / 3.600 Lumen  
3.000 Kelvin  
**674011207**



# WACO

Mit ihrer unauffälligen und reduzierten Ästhetik bringt WACO minimalistischen Stil in die eigenen vier Wände, ohne aufdringlich zu wirken.

With its unobtrusive and minimalist aesthetics, WACO brings minimalist style into your own four walls without being obtrusive.



## DIP SWITCH

Mittels DIP-SWITCH können drei Lichtfarben (Warmweiß, Neutralweiß, Universalweiß) über einen Schalter direkt an der Leuchte eingestellt werden.

The DIP SWITCH directly sets the luminaire's three light colours (warm, neutral and universal white).

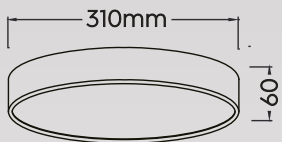

Deckenleuchte · Ceiling lamp

incl. SMD-LED  
28 W / 3.200 Lumen  
2.300 + 3.000 + 4.000 Kelvin

627413031  
627413032  
627413087

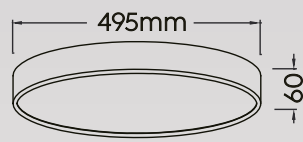

Deckenleuchte · Ceiling lamp

incl. SMD-LED  
52,5 W / 6.200 Lumen  
2.300 + 3.000 + 4.000 Kelvin

627415031  
627415032  
627415087

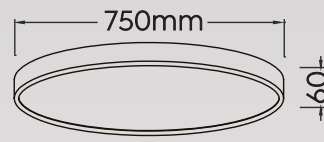



Deckenleuchte · Ceiling lamp

incl. SMD-LED  
100 W / 12.400 Lumen  
2.300 + 3.000 + 4.000 Kelvin

627417531  
627417532  
627417587

Metall, Acryl · metal, acryl

 31 | Weiß matt · white mat

 32 | Schwarz matt · black mat

 87 | titanfarbig · titan







# GIRONA

GIRONA ist dank ihres schlichten Designs und der klaren runden Form, ideal um minimalistisches Wohnen zu verwirklichen.

Thanks to its simple design and clear round shape, GIRONA is ideal for realising minimalist living.



## SWITCH DIMMER

Helligkeit in 3 Stufen mit herkömmlichem Lichtschalter einstellbar.

Brightness adjustable in 4 levels with conventional light switch.

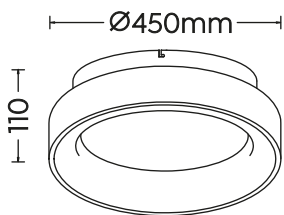

Deckenleuchte · Ceiling lamp  
incl. SMD-LED  
27 W / 3.200 Lumen  
4.000 Kelvin  
671210131

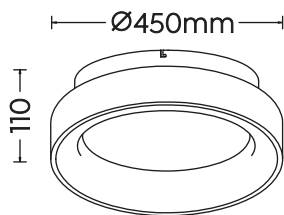

Deckenleuchte · Ceiling lamp  
incl. SMD-LED  
27 W / 3.100 Lumen  
3.000 Kelvin  
671210132



Metall, Acryl · metal, acryl

31 | Weiß matt · white mat

32 | Schwarz matt · black mat



Lichtfarbe stufenlos einstellbar ·  
Light color infinitely variable



Integrierter Dimmer ·  
Integrated dimmer



Memory Funktion ·  
Memory function

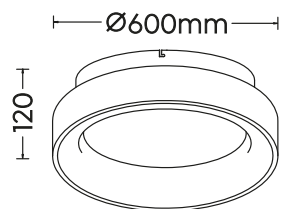

Deckenleuchte · Ceiling lamp

incl. SMD-LED  
48 W / 5.600 Lumen  
2.700 - 6.000 Kelvin

**671290131**  
**671290132**



IP20

# DOHA

Dank ihrer exzellenten Lichtqualität sorgen diese Leuchten für eine gleichmäßige und angenehme Ausleuchtung Ihrer Räume.

Thanks to their excellent quality of light, these luminaires provide uniform and pleasant illumination for your rooms.



## DIP SWITCH

Mittels DIP-SWITCH können drei Lichtfarben (Warmweiß, Neutralweiß, Tageslichtweiß) über einen Schalter direkt an der Leuchte eingestellt werden.

The DIP SWITCH directly sets the luminaire's three light colours (warm, neutral and daylight white).

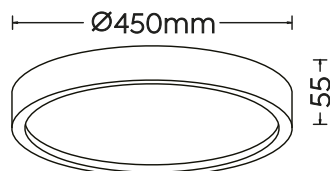

Deckenleuchte · Ceiling lamp

incl. SMD-LED

29 W / 3.260 Lumen

2.300 + 3.000 + 4.000 Kelvin

641310208

641310231

641310232

641310265

Metall, Acryl · metal, acryl

 **08** | Messing matt · brass mat

 **31** | Weiß matt · white mat

 **32** | Schwarz matt · black mat

 **65** | Coffee · coffee





**Getrennt schaltbar**

Die Leuchte verfügt über mehrere Lichtquellen die sich getrennt voneinander ein- und ausschalten lassen.

**Separately switchable**

The light fitting has several light sources that can be switched on and off separately.

# MIKO

Dank außergewöhnlicher Helligkeit und einem Durchmesser von 85 cm, sowie strahlendem Starlight-Effekt beeindruckt MIKO auf allen Ebenen.

Thanks to its exceptional brightness and a diameter of 85 cm, as well as its radiant starlight effect, MIKO impresses on all levels.



Acryl · acryl



06 | Chrome · chrome

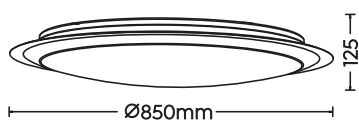

Deckenleuchte · Ceiling lamp

incl. SMD-LED

90 W / 10.800 Lumen

3.000 - 5.500 Kelvin

675610106



Lichtfarbe stufenlos einstellbar ·  
Light color infinitely variable



Integrierter Dimmer ·  
Integrated dimmer



Memory Funktion ·  
Memory function



# TOKYO

Mit ihrem beeindruckenden Durchmesser von 60 cm und einer besonders hellen Ausleuchtung zieht TOKYO alle Blicke auf sich und verleiht jedem Raum eine beeindruckende Präsenz.

With its impressive diameter of 60 cm and particularly bright illumination, TOKYO attracts everyone's attention and lends any room an impressive presence.

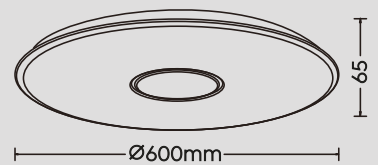

**EASY TO FIX**

Acryl · acryl  
01 | Weiß · white



Lichtfarbe stufenlos einstellbar ·  
Light color infinitely variable



Memory Funktion ·  
Memory function

Deckenleuchte · Ceiling lamp  
incl. SMD-LED  
43 W / 5.000 Lumen  
3.000 - 5.500 Kelvin  
**628915001**



IP20

# OSAKA



Starlight Effekt ·  
Starlight effect



Acryl · acryl

06 | Chrome · chrome

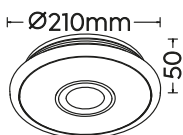

Deckenleuchte · Ceiling lamp  
incl. SMD-LED  
12 W / 1.160 Lumen  
3.000 Kelvin  
**678711206**



Deckenleuchte · Ceiling lamp  
incl. SMD-LED  
27 W / 3.100 Lumen  
3.000 - 5.500 Kelvin  
**678713006**

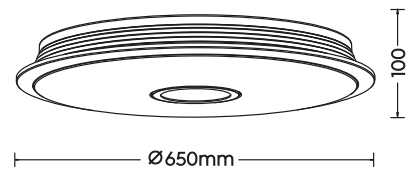

Deckenleuchte · Ceiling lamp  
incl. SMD-LED  
91,5 W / 11.000 Lumen  
3.000 - 5.500 Kelvin  
**678710006**







Lichtfarbe stufenlos einstellbar ·  
Light color infinitely variable



Integrierter Dimmer ·  
Integrated dimmer



Memory Funktion ·  
Memory function



Getrennt schaltbar ·  
Separately switchable

Acryl, Starlight-Effekt · acryl, starlight-effect



06 | Chrome · chrome

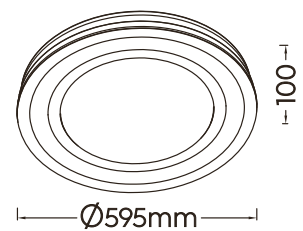

Deckenleuchte · Ceiling lamp  
incl. SMD-LED  
40 W / 4.750 Lumen  
3.000 - 5.500 Kelvin  
**679210106**







IP20

# CHARLY

Smarte Lichtsteuerung: Mit der praktischen Wiz-App kann die Beleuchtung ganz einfach über Smartphone oder Tablet gesteuert werden.

Smart lighting control: With the practical Wiz app, the lighting can be easily controlled via smartphone or tablet.



-  Lichtfarbe stufenlos einstellbar · Light color infinitely variable
-  RGBW Farbwechsler · RGBW Colorchanging
-  Memory Funktion · Memory function
-  Starlight Effekt · Starlight effect



Acryl · acryl

 **00** | Weiß · white

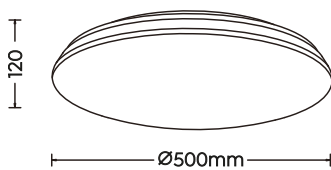
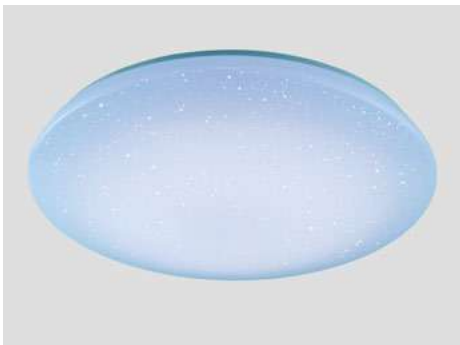

Deckenleuchte · Ceiling lamp  
 incl. RGBW-LED  
 27 W / max. 3.100 Lumen  
 3.000 - 5.500 Kelvin  
**656010100**



**64.000 WEISSTÖNE**  
**64,000 WHITES**



Einstellbare Lichtprogramme · Preset light modes



**16 Millionen FARBEN**  
**16 million COLORS**



Dynamische Lichtprogramme · Dynamic light modes



# NAGANO

Mit einem Durchmesser von knapp 80 cm, intensiver Helligkeit und einem beeindruckenden Starlight-Effekt wird diese Leuchte zum Highlight in jedem Raum.

With a diameter of just under 80 cm, intense brightness and an impressive starlight effect, this luminaire is a highlight in any room.



Integrierter Dimmer ·  
Integrated dimmer



Memory Funktion ·  
Memory function



Lichtfarbe stufenlos einstellbar ·  
Light color infinitely variable



Acryl · acryl



00 | Weiß · white

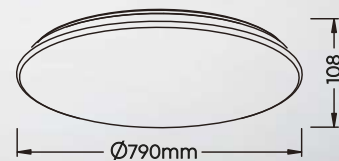

Deckenleuchte · Ceiling lamp  
incl. SMD-LED  
max. 72 W / max. 8.500 Lumen  
3.000 - 5.500 Kelvin  
**677718000**



IP20

# SHOGUN



Lichtfarbe stufenlos einstellbar ·  
Light color infinitely variable



Integrierter Dimmer ·  
Integrated dimmer



Memory Funktion ·  
Memory function



Deckenleuchte · Ceiling lamp  
incl. SMD-LED  
21,5 W / 2.400 Lumen  
3.000 - 5.500 Kelvin  
628513001

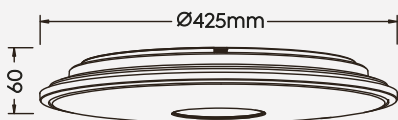

IP20

Acryl · acryl



01 | Weiß · white

# SAMURAI



Lichtfarbe stufenlos einstellbar ·  
Light color infinitely variable



Integrierter Dimmer ·  
Integrated dimmer



Memory Funktion ·  
Memory function

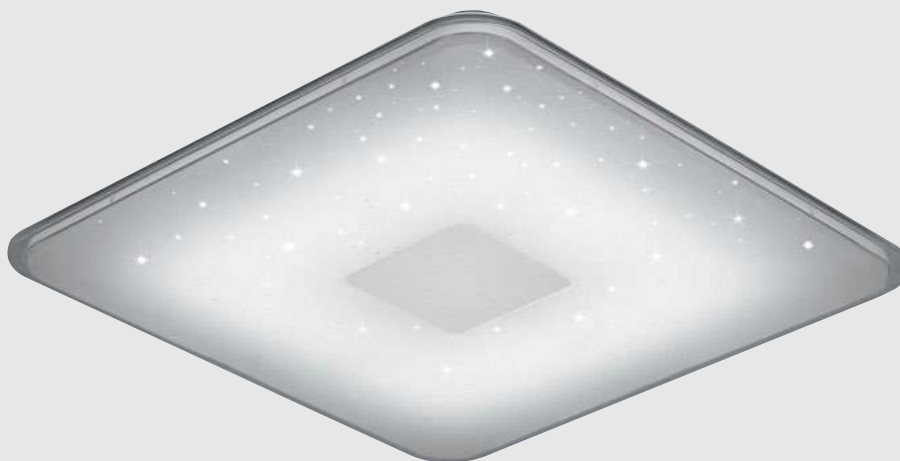

Deckenleuchte · Ceiling lamp  
incl. SMD-LED  
21,5 W / 2.400 Lumen  
3.000 - 5.500 Kelvin  
628613001

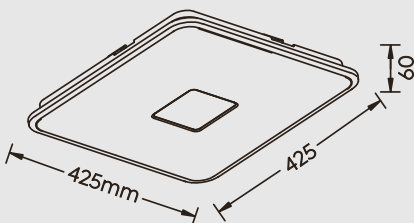

IP20

Acryl · acryl



01 | Weiß · white



Integrierter Dimmer ·  
Integrated dimmer



Nachtlicht ·  
Night light

Kunststoff · plastic



00 | Transparent · transparent

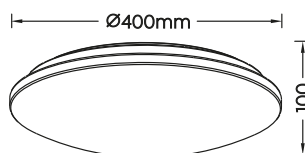

Deckenleuchte · Ceiling lamp  
incl. SMD-LED  
22 W / 2.460 Lumen  
3.000 Kelvin  
627514000

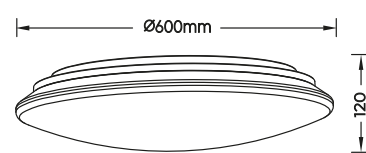

Deckenleuchte · Ceiling lamp  
incl. SMD-LED  
40 W / 4.620 Lumen  
3.000 Kelvin  
627516000



Musterschutz ·  
Registered model

# GONZALO

Kunststoff · plastic

87 | titanfarbig · titan

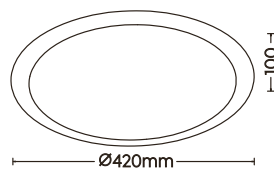
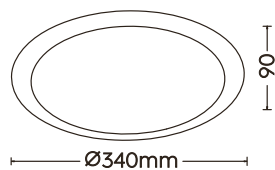
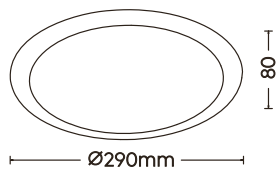

Deckenleuchte · Ceiling lamp  
incl. SMD-LED  
9 W / 900 Lumen  
3.000 Kelvin  
626510987

Deckenleuchte · Ceiling lamp  
incl. SMD-LED  
12 W / 1.050 Lumen  
3.000 Kelvin  
626511287

Deckenleuchte · Ceiling lamp  
incl. SMD-LED  
25 W / 2.600 Lumen  
3.000 Kelvin  
626512587



# CESAR

Acryl mit Kristalleffekt ·  
crystal effect



06 | Chrome · chrome



## SWITCH DIMMER

Helligkeit in 3 Stufen mit  
herkömmlichem Lichtschalter  
einstellbar.

Brightness adjustable in 4 levels  
with conventional light switch.

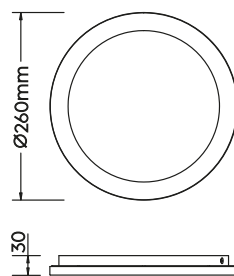

Deckenleuchte · Ceiling lamp  
incl. SMD-LED  
13 W / 1.500 Lumen  
3.000 Kelvin  
**656411506**

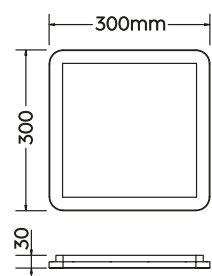

Deckenleuchte · Ceiling lamp  
incl. SMD-LED  
16 W / 1.900 Lumen  
3.000 Kelvin  
**656511806**



# LANA

Glas Weiß matt oder alabasterfarbig ·  
glass white mat or alabaster-coloured

○ 01 | Weiß · white

● 07 | Nickel matt · nickel mat

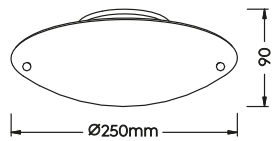
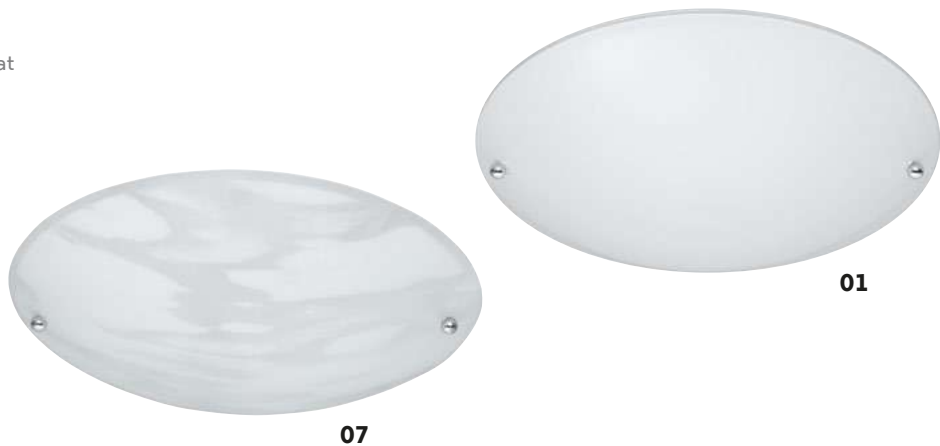

Deckenleuchte · Ceiling lamp

excl. 1 x E27

max. 40 W

6196011-01

6196011-07



# ADRIAN

Metall Nickel matt, Glas alabasterfarbig ·  
metal nickel mat, alabaster-coloured glass

○ 01 | Weiß · white

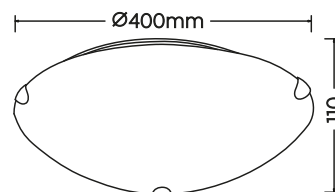
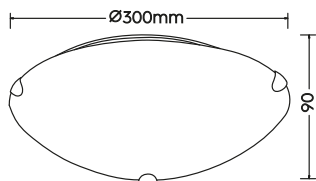

Deckenleuchte · Ceiling lamp

excl. 1 x E27

max. 40 W

6105011-01

Deckenleuchte · Ceiling lamp

excl. 2 x E27

max. 40 W

6105021-01







## DIVO

Metall, Glas Weiß · metal, glass white

 **06** | Chrome · chrome

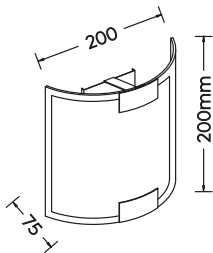

Wandleuchte · Wall lamp  
excl. 1 x E14  
max. 40 W  
**2522011-06**



## PURA

Metall, Glas Weiß · metal, glass white

 **04** | Altmessing · old brass  
 **07** | Nickel matt · nickel mat

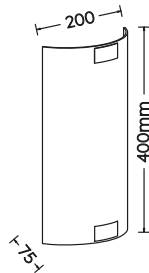

Wandleuchte · Wall lamp  
excl. 2 x E27  
max. 25 W  
**212700204**  
**212700207**

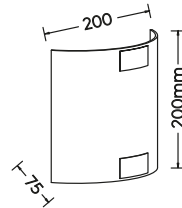

Wandleuchte · Wall lamp  
excl. 1 x E27  
max. 40 W  
**212700104**  
**212700107**



## Leuchten aus Gips - vielseitig und stilvoll

Leuchten aus Gips lassen sich dank ihrer Oberfläche nach Belieben überstreichen und können so als unauffällige, aber auch herausstechende Beleuchtung eingesetzt werden.

## Plaster luminares - versatile and stylish

Thanks to their surface, plaster luminares can be painted as desired and can therefore be used as unobtrusive but also striking lighting.

# LILLY

Gips · Gypsum

01 | Weiß · white

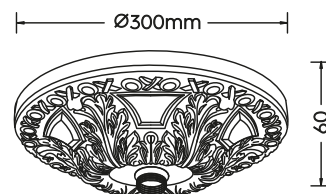

Deckenleuchte · Ceiling lamp

excl. 1 x E27

max. 40 W

603300101



# ROMA

Gips · Gypsum

01 | Weiß · white

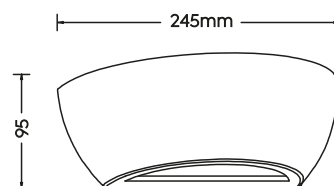

Wandleuchte · Wall lamp

excl. 1 x E14

max. 28 W

201000101



# ZAZOU

Gips · Gypsum

01 | Weiß · white

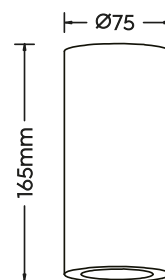

Wandleuchte · Wall lamp

excl. 2 x GU10

max. 10 W

201100201



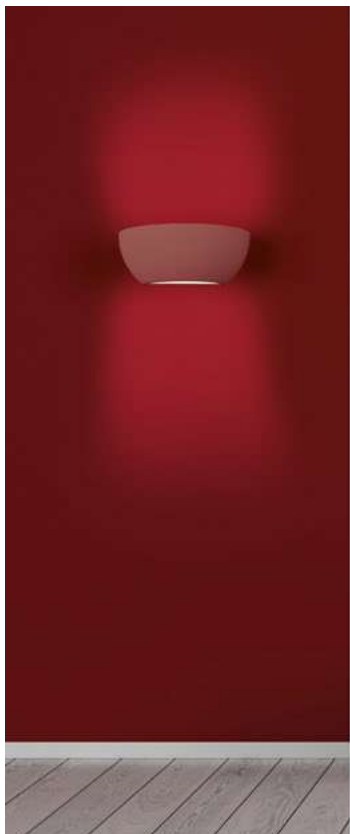

# QUINTA

Das klassische Erscheinungsbild dieser Deckenleuchte unterstreicht sowohl rustikale wie auch mediterrane Einrichtungsstile. Mit sanftem, blendfreiem Licht verleiht sie Räumen ein wohliches Ambiente.

The classic appearance of this ceiling light emphasises both rustic and Mediterranean furnishing styles. With soft, glare-free light, it gives rooms a cosy ambience.

Metall, Glas alabasterfarbig ·  
metal, alabaster-coloured glass

24 | rostfarbig · rusty

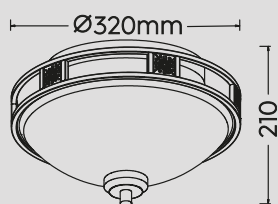

Deckenleuchte · Ceiling lamp  
excl. 2 x E27  
max. 42 W  
**608100224**

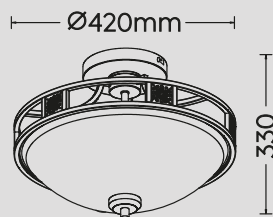

Deckenleuchte · Ceiling lamp  
excl. 3 x E27  
max. 60 W  
**608100324**



# JOHANN

Durch das einzigartige Design entsteht ein besonderes Lichtspiel, das jedem Raum eine atmosphärische Tiefe verleiht.

The unique design creates a special play of light that adds atmospheric depth to any room.



Metall · metal

- 32 | Schwarz matt · black mat
- 62 | Kupfer antik · antique copper

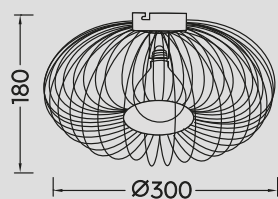

Deckenleuchte · Ceiling lamp  
excl. 1 x E27  
max. 60 W  
**606903032**

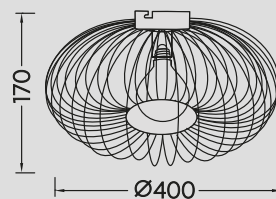

Deckenleuchte · Ceiling lamp  
excl. 1 x E27  
max. 60 W  
**606900132**  
**606900162**

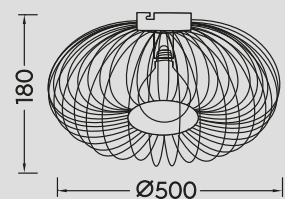

Deckenleuchte · Ceiling lamp  
excl. 1 x E27  
max. 60 W  
**606905032**



# MIO **NEW**

Metall · metal

31 | Weiß matt · white mat

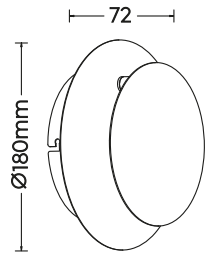

Wandleuchte · Wall lamp  
incl. SMD-LED  
6 W / 560 Lumen  
3.000 Kelvin  
240310131

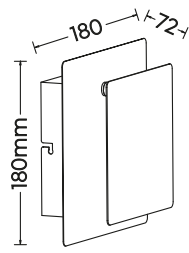

Wandleuchte · Wall lamp  
incl. SMD-LED  
6 W / 560 Lumen  
3.000 Kelvin  
240319131



Individuell verstellbar  
Individually adjustable





Individuell verstellbar  
Individually adjustable



## LEANO NEW

Metall · metal



79 | goldfarbig · gold

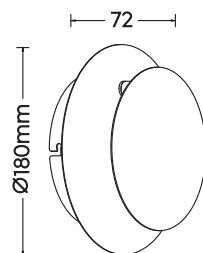

Wandleuchte · Wall lamp  
incl. SMD-LED  
6 W / 560 Lumen  
3.000 Kelvin  
240310179

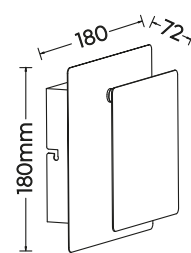

Wandleuchte · Wall lamp  
incl. SMD-LED  
6 W / 560 Lumen  
3.000 Kelvin  
240319179





# CHIROS

Metall · metal

 79 | goldfarbig · gold

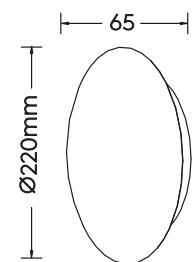

Wandleuchte · Wall lamp  
incl. SMD-LED  
8 W / 800 Lumen  
3.000 Kelvin  
**224110179**

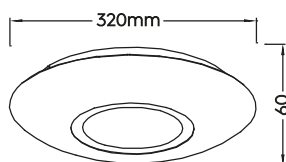

Deckenleuchte · Ceiling lamp  
incl. SMD-LED  
12 W / 1.280 Lumen  
incl. SMD-LED  
3,5 W / 350 Lumen  
3.000 Kelvin  
**624110279**







Up and down Beleuchtung ·  
Up and down lighting

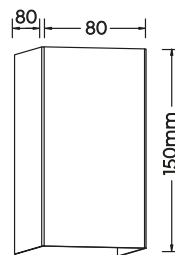

Wandleuchte · Wall lamp  
excl. 2 x GU10  
max. 35 W  
206500279



## CLEO

Metall · metal



79 | goldfarbig · gold

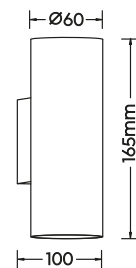

Wandleuchte · Wall lamp  
excl. 2 x GU10  
max. 35 W  
206400279



# LOUIS

Aluminium · aluminium

 **05** | Aluminium gebürstet · brushed aluminium

 **31** | Weiß matt · white mat

 **32** | Schwarz matt · black mat

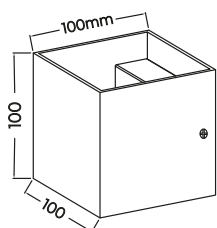

Wandleuchte · Wall lamp

incl. OSRAM-LED  
4,3 W / 430 Lumen  
3.000 Kelvin

2233101**05**

2233101**31**

2233101**32**

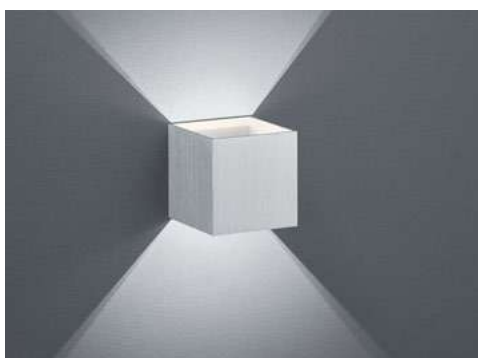

# LACAPO

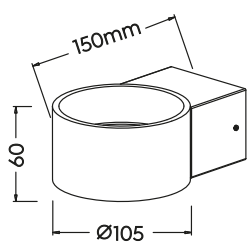

Wandleuchte · Wall lamp

incl. OSRAM-LED  
4,3 W / 430 Lumen  
3.000 Kelvin

2234101**31**

2234101**32**



Metall · metal

 **31** | Weiß matt · white mat

 **32** | Schwarz matt · black mat



Diese elegante Wandleuchte beeindruckt durch ihr formschönes Design und die zweifache Lichtquelle, die sowohl nach oben als auch nach unten strahlt. Erhältlich in den stilvollen Farbkombinationen Schwarz/Gold oder Weiß/Coffee.

This elegant wall light impresses with its elegant design and the dual light source that shines both upwards and downwards. Available in the stylish colour combinations black/gold or white/coffee,

COAT **NEW**

Metall · metal



**31** | Weiß matt / Coffee · white mat / coffee



**80** | Schwarz-Gold · black-gold

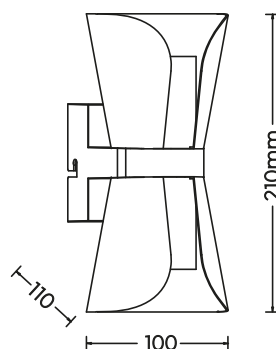

Wandleuchte · Wall lamp

excl. 2 x GU10  
max. 10 W

**218600231**

**218600280**



IP20

# RAVEN

Diese Wandleuchte aus natürlichem Schiefer vereint Funktionalität mit dekorativem Charakter. Ob rund oder eckig, sie wird zu einem echten Highlight an jeder Wand und verleiht dem Raum eine besondere Note.

This wall light made of natural slate combines functionality with decorative character. Whether round or square, it is a real highlight on any wall and adds a special touch to the room.



Schiefer · shale

02 | Schwarz · black



## SWITCH DIMMER

Helligkeit in 3 Stufen mit herkömmlichem Lichtschalter einstellbar.

Brightness adjustable in 4 levels with conventional light switch.

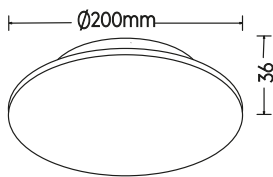

Wandleuchte · Wall lamp

incl. SMD-LED  
9 W / 1.000 Lumen  
3.000 Kelvin

224290102

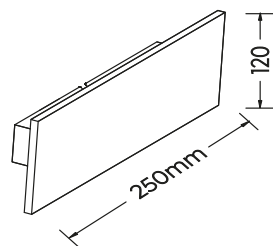

Wandleuchte · Wall lamp

incl. SMD-LED  
9 W / 1.000 Lumen  
3.000 Kelvin

224210102

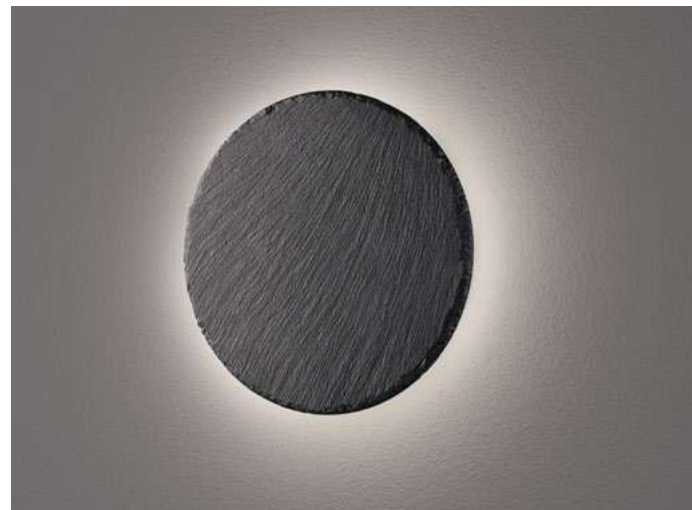

# ARINO

Metall, Holz · metal, wood



32 | Schwarz matt · black mat



## SWITCH DIMMER

Helligkeit in 3 Stufen mit herkömmlichem Lichtschalter einstellbar.

Brightness adjustable in 4 levels with conventional light switch.

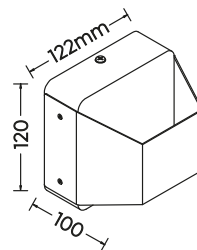

Wandleuchte · Wall lamp  
incl. SMD-LED  
4,3 W / 430 Lumen  
3.000 Kelvin  
224810132

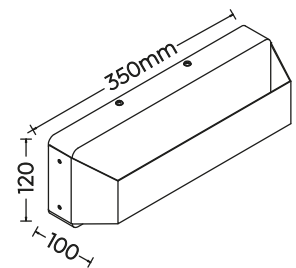

Wandleuchte · Wall lamp  
incl. SMD-LED  
13,5 W / 1.500 Lumen  
3.000 Kelvin  
224819132



# CONCHA

Die klare Linienführung verkörpert minimalistisches Design in seiner reinsten Form und fügt sich harmonisch in jede moderne Einrichtung ein.

The clear lines embody minimalist design in its purest form and blend harmoniously into any modern interior.



## SWITCH DIMMER

Helligkeit in 3 Stufen mit herkömmlichem Lichtschalter einstellbar.

Brightness adjustable in 4 levels with conventional light switch.

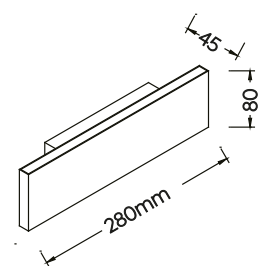

Wandleuchte · Wall lamp

incl. SMD-LED  
2 x 6 W / 2 x 600 Lumen  
3.000 Kelvin

225172924

225172931

225172942

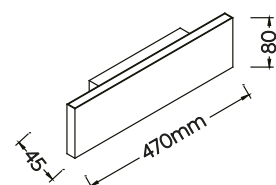

Wandleuchte · Wall lamp

incl. SMD-LED  
2 x 9 W / 2 x 1.000 Lumen  
3.000 Kelvin

225174731

225174742

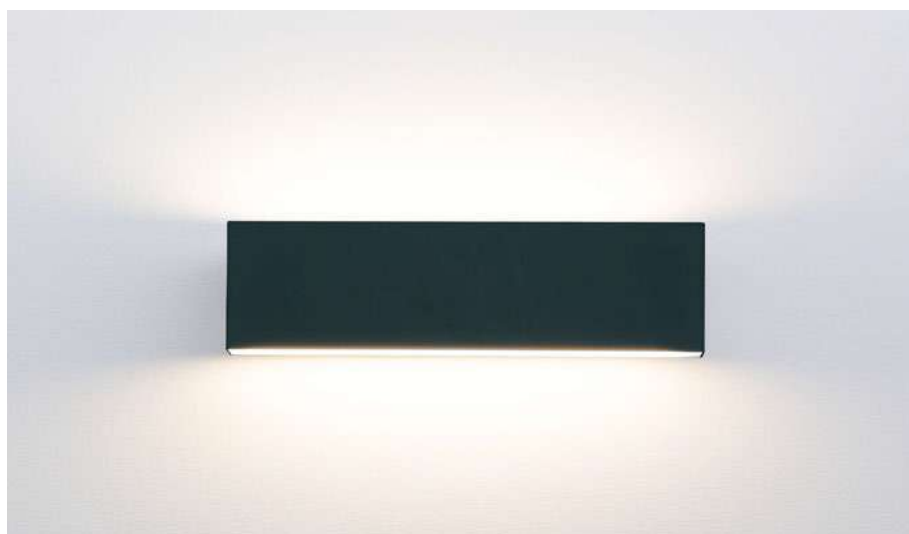
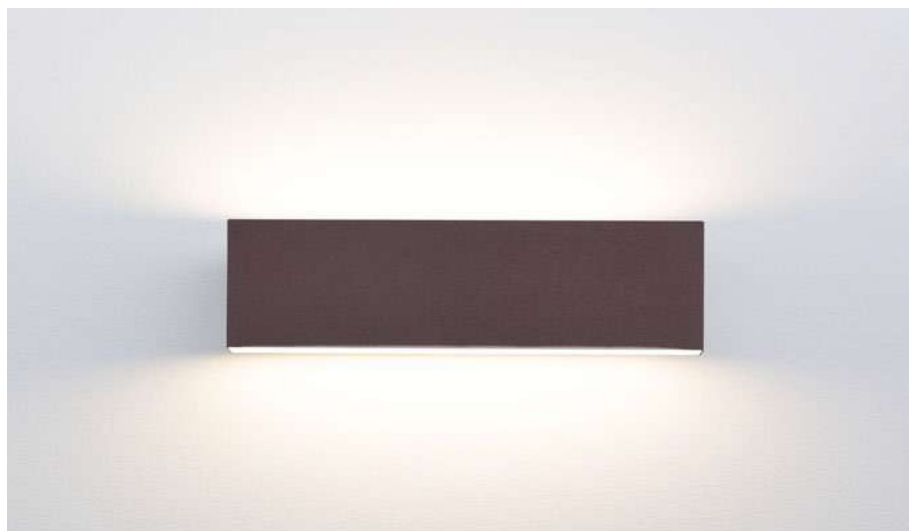

Metall · metal

● 24 | rostfarbig · rusty

○ 31 | Weiß matt · white mat

● 42 | Anthrazit · anthracite



# RAGLAN NEW

Diese moderne Wandleuchte vereint Design und Funktionalität in einem. Der schwenkbare Leuchtenkopf bietet Flexibilität und Anpassungsfähigkeit.

This modern wall light combines design and functionality in one. The swivelling light head offers flexibility and adaptability.

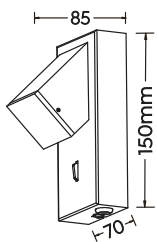

Wandleuchte · Wall lamp

incl. SMD-LED  
3,8 W / 400 Lumen  
3.000 Kelvin

248570131  
248570132

Metall · metal



31 | Weiß matt · white mat



32 | Schwarz matt · black mat





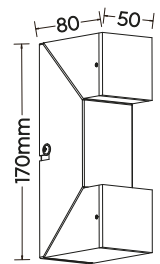

Wandleuchte · Wall lamp  
incl. SMD-LED  
2 x 3,8 W / 2 x 400 Lumen  
3.000 Kelvin  
**248510231**  
**248510232**



# WALES

Metall · metal



07 | Nickel matt · nickel mat

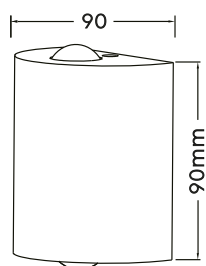

Wandleuchte · Wall lamp  
incl. OSRAM-LED  
2 x 3,1 W / 2 x 310 Lumen  
3.000 Kelvin  
225510207



# PLATON

Metall, Acryl · metal, acryl



05 | Aluminium gebürstet · brushed Aluminium

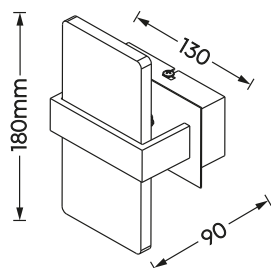

Wandleuchte · Wall lamp  
incl. OSRAM-LED  
4,3 W / 430 Lumen  
3.000 Kelvin  
274670105





Metall · metal



**01** | Weiß · white



**05** | Aluminium gebürstet · brushed Aluminium

## ADRIANO

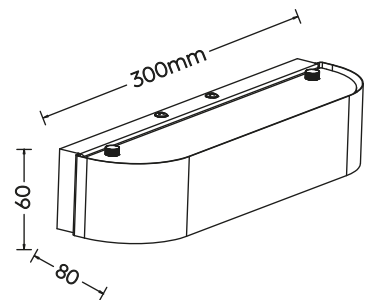

Wandleuchte · Wall lamp

incl. OSRAM-LED

2 x 3,1 W / 2 x 310 Lumen

3.000 Kelvin

**220810201**

**220810205**



IP20

# ELEMENT

Ausgestattet mit einer praktischen Ablage, bietet die Wandleuchte Platz für kleine Gegenstände wie Brille, Smartphone oder Dekoration. Der integrierte USB-Anschluss mit Ladefunktion ermöglicht es Handys oder andere elektronische Geräte bequem aufzuladen.

Equipped with a practical shelf, the wall light offers space for small items such as glasses, smartphones or decorations. The integrated USB port with charging function makes it easy to charge mobile phones or other electronic devices.



USB Anschluss mit Ladefunktion ·  
Recharging USB-C connection



Getrennt schaltbar ·  
Separately switchable

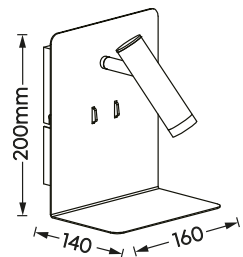
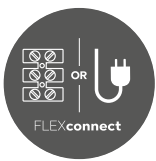

Wandleuchte · Wall lamp

incl. SMD-LED  
3 W / 220 Lumen

incl. SMD-LED  
2 x 1,5 W / 2 x 150 Lumen  
3.000 Kelvin

222570231

222570232



IP20



Metall · metal

31 | Weiß matt · white mat



32 | Schwarz matt · black mat



# FAIRFIELD NEW

Mit ihrem schlichten Design und der praktischen Smartphone Ablage für induktives Laden vereint diese Leuchte minimalistische Ästhetik mit zeitgemäßer Technologie.

With its simple design and practical smartphone holder for inductive charging, this light combines minimalist aesthetics with contemporary technology.



## SWITCH DIMMER

Helligkeit in 3 Stufen mit herkömmlichem Lichtschalter einstellbar.

Brightness adjustable in 4 levels with conventional light switch.



Induktive Ladestation · Inductive loading station



USB Anschluss mit Ladefunktion · Recharging USB connection



USB-C Anschluss mit Ladefunktion · Recharging USB-C connection

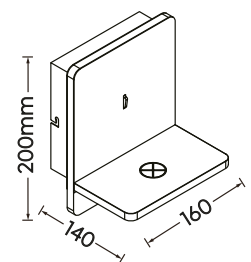
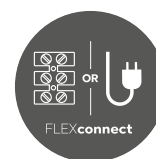

Wandleuchte · Wall lamp

incl. SMD-LED  
9 W / 950 Lumen  
3.000 Kelvin

248670131

248670132

Metall · metal



31 | Weiß matt · white mat



32 | Schwarz matt · black mat



IP20



# KAZAN



Integrierter Dimmer ·  
Integrated dimmer

Metall · metal



32 | Schwarz matt · black mat

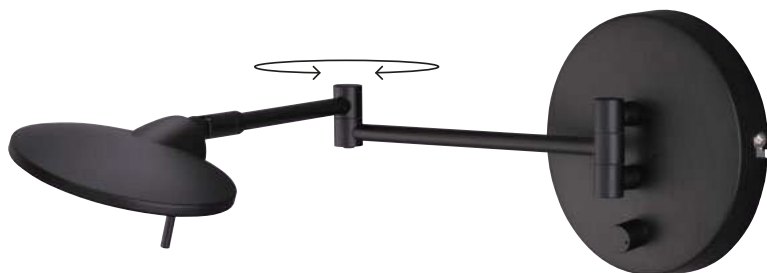
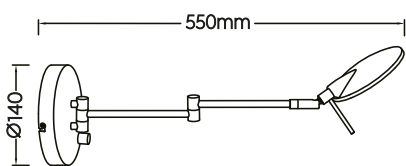

Wandleuchte · Wall lamp

incl. SMD-LED  
8 W / 800 Lumen  
3.000 Kelvin

274770132



IP20



# COMFORT NEW

COMFORT bietet durch den Stoffschirm ein angenehmes Licht, während die Akzentbeleuchtung am Bett für eine beruhigende und gemütliche Atmosphäre sorgt.

COMFORT provides a pleasant light thanks to the fabric shade, while the accent lighting on the bed creates a calming and cosy atmosphere.

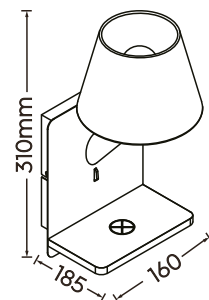
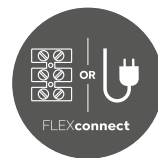

Induktive Ladestation · Inductive loading station



USB Anschluss mit Ladefunktion · Recharging USB connection



USB-C Anschluss mit Ladefunktion · Recharging USB-C connection

Metall, Stoffschirm · metal, fabric shade



**31** | Weiß matt · white mat



**32** | Schwarz matt · black mat

Wandleuchte · Wall lamp

excl. 1 x E14  
max. 28 W

**262670131**

**262670132**



# JORDAN

Metall, Acryl · metal, acryl

-  **07** | Nickel matt · nickel mat
-  **31** | Weiß matt · white mat
-  **32** | Schwarz matt · black mat

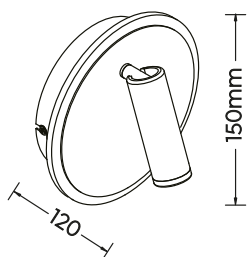

Wandleuchte · Wall lamp

incl. SMD-LED  
5 W / 550 Lumen

incl. SMD-LED  
2 W / 200 Lumen  
3.000 Kelvin

229210207

229210231

229210232



# MARIO

Metall · metal

-  **31** | Weiß matt · white mat
-  **32** | Schwarz matt · black mat

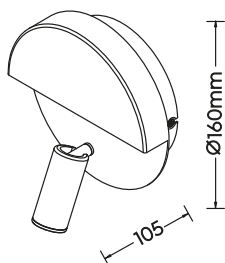

Wandleuchte · Wall lamp

incl. SMD-LED  
6 W / 600 Lumen

incl. SMD-LED  
2,3 W / 200 Lumen  
3.000 Kelvin

222370231

222370232





# MARRIOT

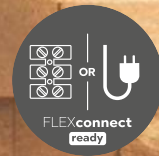

Getrennt schaltbar ·  
Separately switchable

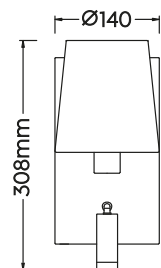

Wandleuchte · Wall lamp

excl. 1 x E14  
max. 40 W  
incl. OSRAM-LED  
3,1 W / 310 Lumen  
3.000 Kelvin

271470207

271470279

Metall, Stoffschirm Weiß oder Schwarz ·  
metal, fabric shade white or black



07 | Nickel matt · nickel mat



79 | goldfarbig · gold



IP20

# BALDO

Metall · metal

● 32 | Schwarz matt · black mat

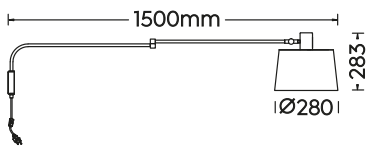

Wandleuchte · Wall lamp

excl. 1 x E27

max. 40 W

200600132



# BOLDER

Metall · metal

● 32 | Schwarz matt · black mat

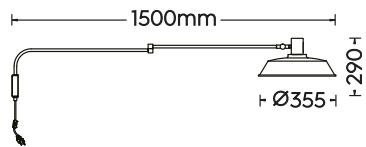

Wandleuchte · Wall lamp

excl. 1 x E27

max. 40 W

200300132



# LINE

Metall · metal

● 32 | Schwarz matt · black mat

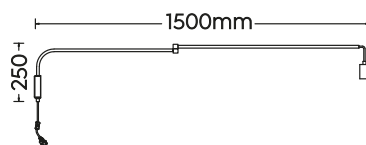

Wandleuchte · Wall lamp

excl. 1 x E27

max. 10 W

200200132





# CUADRO



Metall · metal

 **04** | Altmessing · old brass

 **07** | Nickel matt · nickel mat

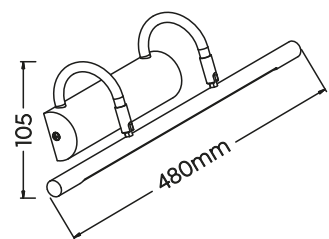

Wandleuchte · Wall lamp

incl. SMD-LED  
8 W / 900 Lumen  
3.000 Kelvin

**225210104**

**225210107**

 IP20



# CURTIS



Metall · metal

-  **04** | Altmessing · old brass
-  **07** | Nickel matt · nickel mat
-  **08** | Messing matt · brass mat
-  **32** | Schwarz matt · black mat

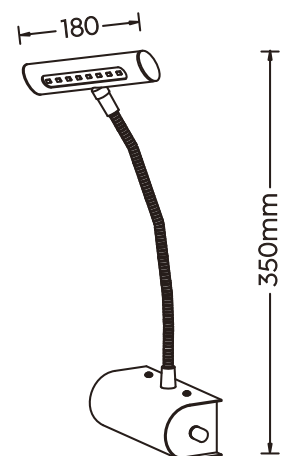

Wandleuchte · Wall lamp

incl. SMD-LED  
4 W / 430 Lumen  
3.000 Kelvin

**279770104**

**279770107**

**279770108**

**279770132**



# WANDA

Metall, Kunststoff · metal, plastic

-  **07** | Nickel matt · nickel mat
-  **08** | Messing matt · brass mat
-  **31** | Weiß matt · white mat
-  **32** | Schwarz matt · black mat

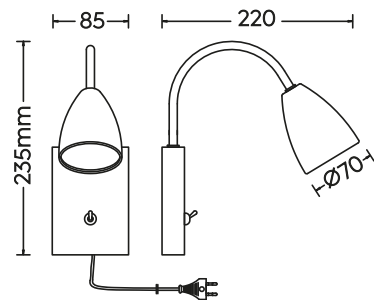

Wandleuchte · Wall lamp  
 excl. 1 x GU10  
 max. 10 W  
**202670107**  
**202670108**  
**202670131**  
**202670132**

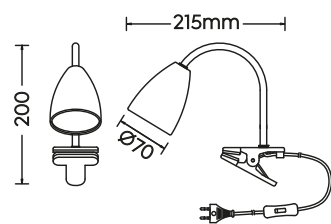



Klemmleuchte · Clamp light  
 excl. 1 x GU10  
 max. 10 W  
**202620131**  
**202620132**





# LIGARA

Metall, Kunststoff Weiß ·  
metal, plastic white

-  **07** | Nickel matt · nickel mat
-  **32** | Schwarz matt · black mat





Steckerleuchte · Plug light  
excl. 1 x E14  
max. 10 W

**8911211-07**  
**8911211-32 NEW**



# LEVISTO

Metall, Glas alabasterfarbig ·  
metal, alabaster-coloured glass

-  **07** | Nickel matt · nickel mat
-  **32** | Schwarz matt · black mat



Steckerleuchte · Plug light

incl. LED E14  
4,9 W / 470 Lumen  
3.000 Kelvin

**891010107**  
**891010132 NEW**



*incl.*  
LED E14  
4,9 W / 470 Lumen  
3.000 Kelvin



# RAMON

Kunststoff · plastic

01 | Weiß · white

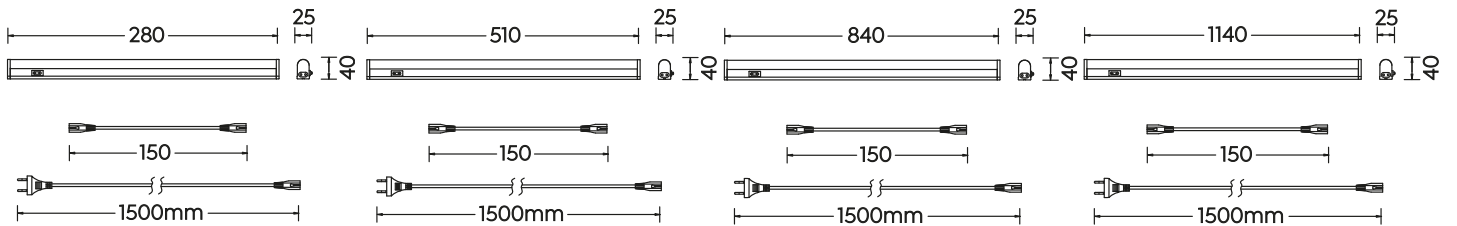
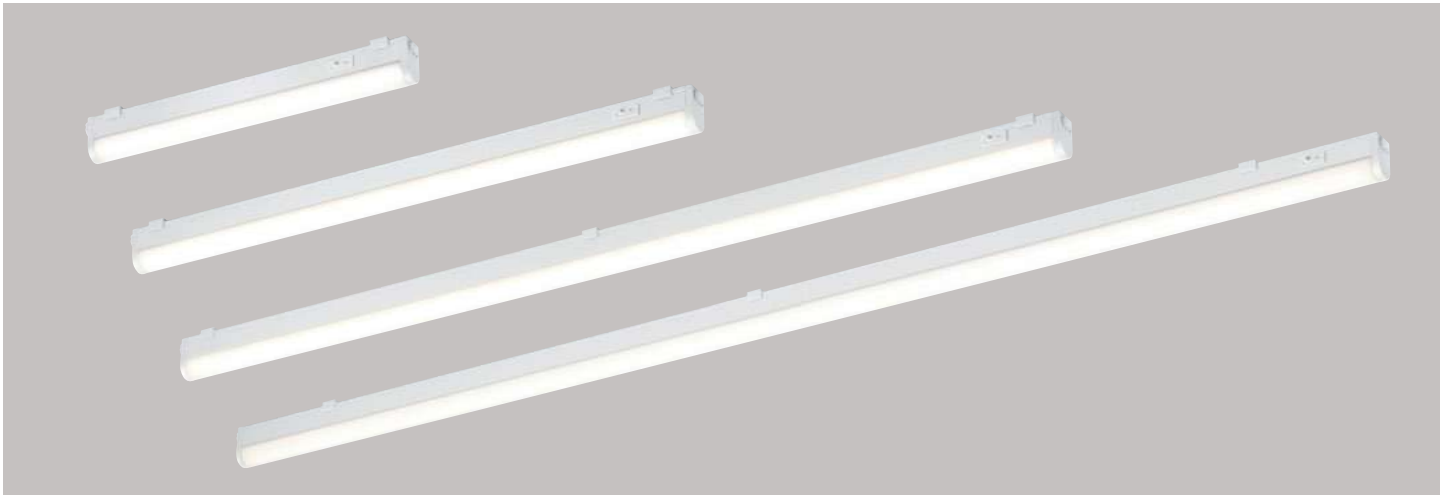

Unterbauleuchte · Cabinet lighting  
incl. SMD-LED  
3,5 W / 400 Lumen  
3.000 Kelvin  
**273070401**



Unterbauleuchte · Cabinet lighting  
incl. SMD-LED  
6,5 W / 700 Lumen  
3.000 Kelvin  
**273070701**



Unterbauleuchte · Cabinet lighting  
incl. SMD-LED  
12 W / 1.400 Lumen  
3.000 Kelvin  
**273071301**



Unterbauleuchte · Cabinet lighting  
incl. SMD-LED  
16,5 W / 1.850 Lumen  
3.000 Kelvin  
**273071801**







# ALINO

Kunststoff · plastic



**01** | Weiß · white



**87** | titanfarbig · titan

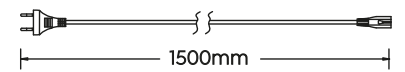
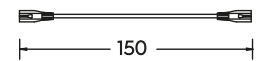
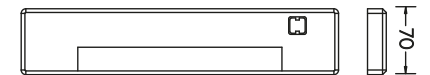
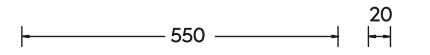

Unterbauleuchte · Cabinet lighting

incl. SMD-LED  
7 W / 600 Lumen  
3.000 Kelvin

**272970701**  
**272970787**



# ECCO

Metall · metal



**07** | Nickel matt · nickel mat



**Set: 3 St./3 pc.**

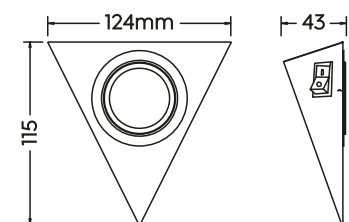

Unterbauleuchte · Cabinet lighting

incl. 3 x SMD-LED  
3 x 3 W / 3 x 200 Lumen  
3.000 Kelvin

**273370307**







# TISCH- & STEHLEUCHTEN

## TABLE & FLOOR LAMPS

Tisch- und Stehleuchten sind nicht nur funktionale Lichtquellen, sondern auch dekorative Elemente, die jedem Raum eine besondere Note verleihen können.

Table and floor lamps are not only functional light sources, but also decorative elements that can add a special touch to any room.

# WILLIS NEW

Diese Stehleuchte mit integriertem Leselicht besticht durch ihr außergewöhnliches Design und ihre vielseitige Funktionalität. Die innovative Formgebung setzt stilvolle Akzente und macht die Leuchte zu einem echten Hingucker in jedem Raum.

This floor lamp with integrated reading light impresses with its unusual design and versatile functionality. The innovative design sets stylish accents and makes the light a real eye-catcher in any room.



Lichtfarbe einstellbar ·  
Adjustable light color



Sensordimmer ·  
Sensor dimmer



Getrennt schaltbar ·  
Separately switchable

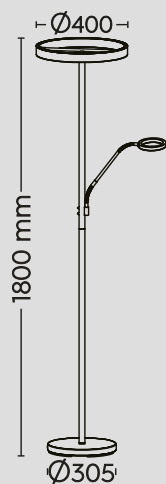

Stehleuchte · Floor lamp

incl. SMD-LED

39 W / 4.600 Lumen

incl. SMD-LED

5 W / 550 Lumen

2.700 + 3.200 + 4.000 Kelvin

449510207

449510232

449510279



Metall · metal



07 | Nickel matt · nickel mat



32 | Schwarz matt · black mat



79 | goldfarbig · gold



IP20

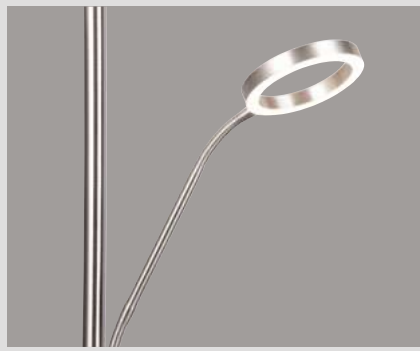

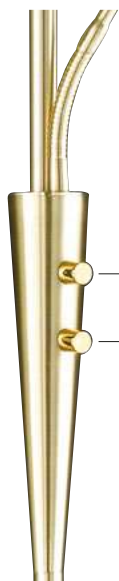

Dimmen · dimming  
Lichtfarbe einstellen ·  
adjusting light color

Metall · metal

07 | Nickel matt · nickel mat

08 | Messing matt · brass mat

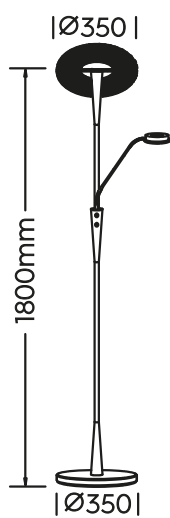

Stehleuchte · Floor lamp  
incl. SMD-LED  
35 W / 4.200 Lumen  
5,5 W / 600 Lumen  
3.000 + 4.500 + 6.500 Kelvin  
**422710307**  
**422710308**



Lichtfarbe einstellbar ·  
Adjustable light color



Integrierter Dimmer ·  
Integrated dimmer



# QUEBEC

Dieser Deckenfluter ist nicht nur ein optisches Highlight, sondern auch ein technisches Meisterwerk, das Komfort und Stil in Einklang bringt.

This ceiling washlight is not only a visual highlight, but also a technical masterpiece that harmonises comfort and style.



# BRANTFORD

Über einen integrierten Sensordimmer lassen sich Helligkeit sowie Lichtfarbe problemlos dimmen und einstellen. Die Hauptlichtquelle lässt sich zudem getrennt von dem Lesearm schalten.

Brightness and light colour can be easily dimmed and adjusted using an integrated sensor dimmer. The main light source can also be switched separately from the reading arm.



Lichtfarbe einstellbar ·  
Adjustable light color



Sensordimmer ·  
Sensor dimmer



Memory Funktion ·  
Memory function

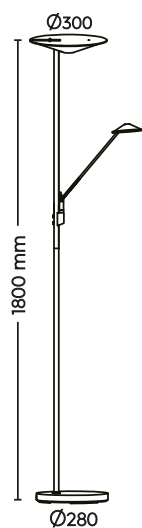

Stehleuchte · Floor lamp

incl. SMD-LED

30 W / 3.500 Lumen

incl. SMD-LED

6,5 W / 650 Lumen

2.700 + 3.200 + 4.000 Kelvin

425610204

425610207

425610232



IP20



Metall · metal

04 | Altmessing · old brass

07 | Nickel matt · nickel mat

32 | Schwarz matt · black mat







Lichtfarbe einstellbar ·  
Adjustable light color



Sensordimmer ·  
Sensor dimmer



Memory Funktion ·  
Memory function

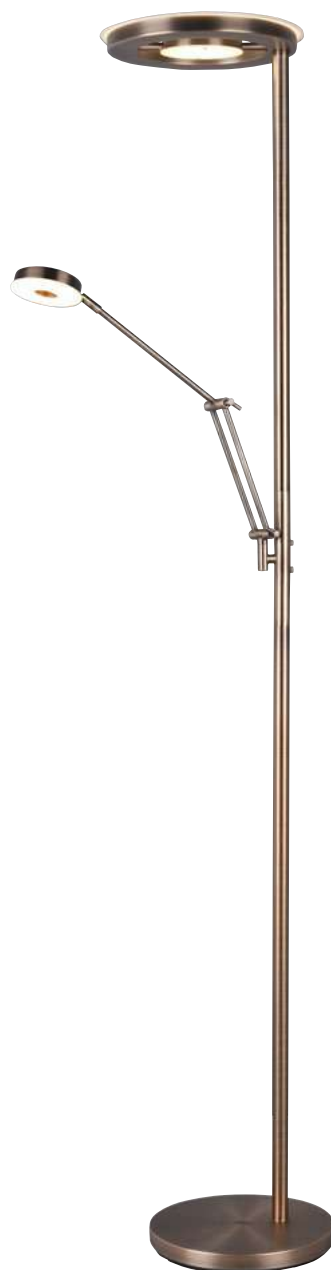
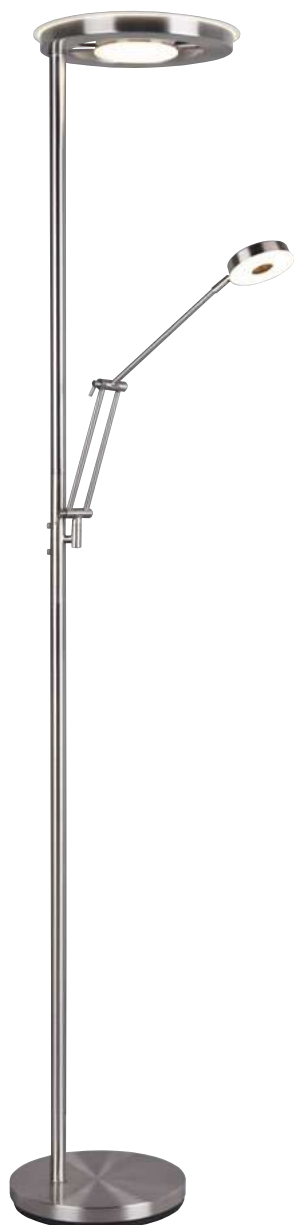

-  Metall · metal
-  **04** | Altmessing · old brass
-  **07** | Nickel matt · nickel mat
-  **32** | Schwarz matt · black mat

Stehleuchte · Floor lamp

incl. SMD-LED  
32 W / 3.700 Lumen

incl. SMD-LED  
6 W / 700 Lumen  
2.700 + 4.000 Kelvin

**424210304**

**424210307**

**424210332**

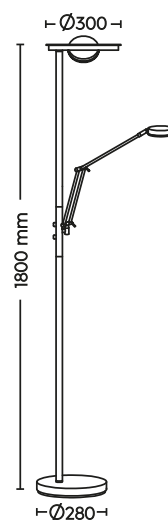

# BARRIE

Dieser Deckenfluter bietet Ihnen höchste Flexibilität und Komfort. Die individuellen Lichteinstellungen ermöglichen es, sowohl die Helligkeit als auch die Lichtfarbe getrennt voneinander zu variieren.

This ceiling washlight offers you maximum flexibility and comfort. The individual light settings make it possible to vary both the brightness and the light colour separately.





Metall, Acryl mit Kristalleffekt ·  
metal, crystal effect

 **06** | Chrome · chrome

Metall · metal

 **07** | Nickel matt · nickel mat

## CHRIS

Stehleuchte · Floor lamp

incl. SMD-LED  
18 W / 2.000 Lumen  
3,8 W / 350 Lumen  
3.000 Kelvin

478310206

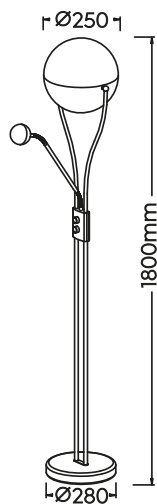

## SPLIT

Stehleuchte · Floor lamp

incl. SMD-LED  
18 W / 2.000 Lumen  
3,5 W / 400 Lumen  
3.000 - 6.500 Kelvin

424910207

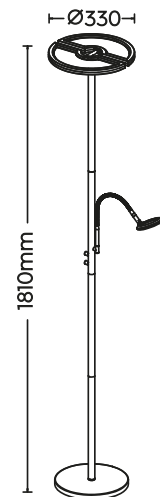



Metall, Glas alabasterfarbig ·  
metal, alabaster-coloured glass

07 | Nickel matt · nickel mat

Metall · metal

07 | Nickel matt · nickel mat

08 | Messing matt · brass mat

## SANTO II

Stehleuchte · Floor lamp

incl. 4 x SMD-LED  
4,8 W / 4 x 450 Lumen  
4,8 W / 450 Lumen  
3.000 Kelvin

421910207

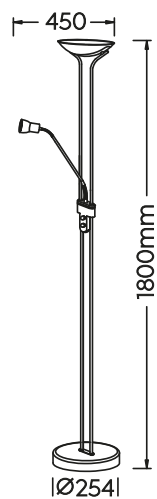

## ARIZONA

Stehleuchte · Floor lamp

incl. SMD-LED  
20 W / 2.200 Lumen  
5 W / 500 Lumen  
3.000 Kelvin

426410207

426410208

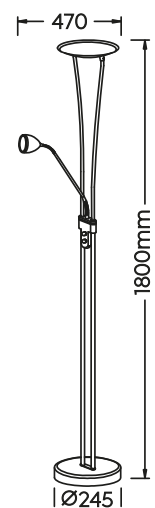

# SHANGHAI



Metall · metal



01 | Weiß · white



02 | Schwarz · black

Stehleuchte · Floor lamp

incl. SMD-LED  
18 W / 2.000 Lumen  
3.000 Kelvin

427511801

427511802



IP20

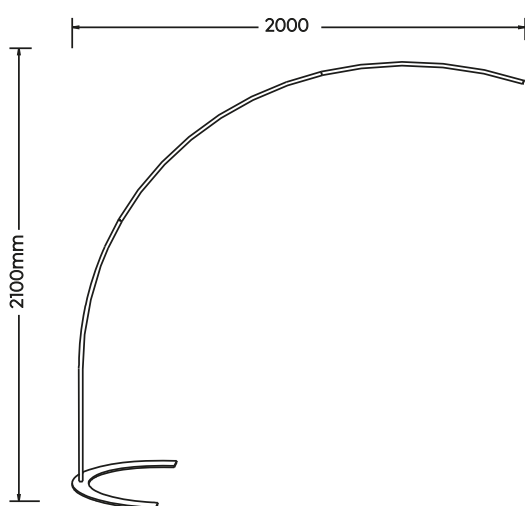

# BANGKOK

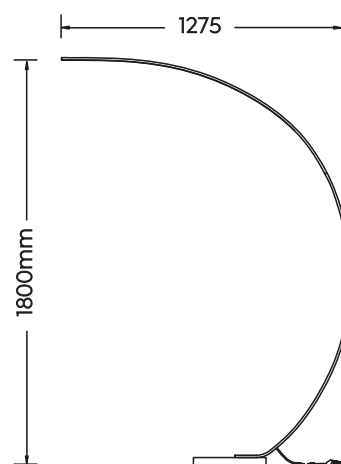

Metall, Marmor · metal, marble



32 | Schwarz matt · black mat

Stehleuchte · Floor lamp  
incl. SMD-LED  
18 W / 2.200 Lumen  
3.000 Kelvin  
**426511832**



IP20

# ARGENTINA



Metall, Marmor · metal, marble

07 | Nickel matt · nickel mat

08 | Messing matt · brass mat

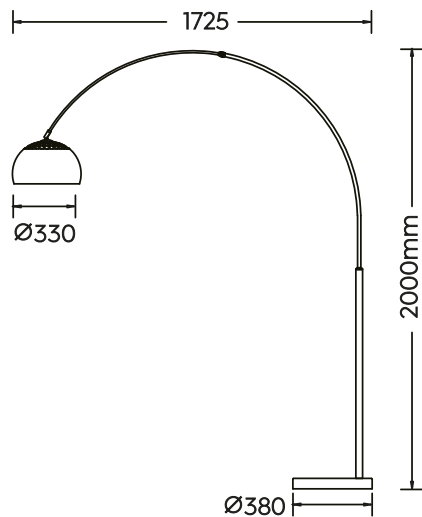

Stehleuchte · Floor lamp

excl. 1 x E27

max. 60 W

411700107

411700108





# LANCE

Die dekorative Gestaltung macht die Stehleuchte LANCE nicht nur zu einer praktischen Lichtquelle, sondern auch zu einem eleganten Wohnaccessoire.

The decorative design makes the LANCE floor lamp not only a practical light source, but also an elegant home accessory.

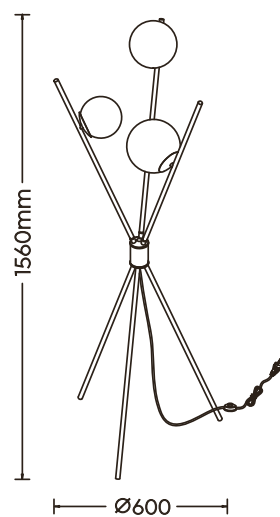

Metall Schwarz matt, Glas ·  
metal black mat, glass



17 | mehrfarbig · multicolor

Stehleuchte · Floor lamp  
excl. 3 x E14  
max. 28 W  
403400317



# MARLEY

Die schlichten Linien und das minimalistische Design lassen das Licht in den Vordergrund treten. Gemeinsam schaffen die Steh- und Tischleuchten ein stimmiges Beleuchtungskonzept, das sowohl funktional als auch ästhetisch überzeugt.

The simple lines and minimalist design allow the light to take centre stage. Together, the floor and table lamps create a harmonious lighting concept that is both functional and aesthetically pleasing.

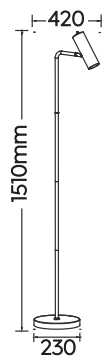

Stehleuchte · Floor lamp

excl. 1 x GU10  
max. 5 W

412400107  
412400108  
412400131  
412400132

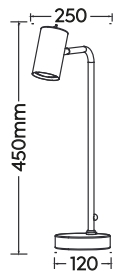

Tischleuchte · Table lamp

excl. 1 x GU10  
max. 5 W

512400107  
512400108  
512400131  
512400132



Empfohlen:  
recommended:

LED GU10  
4,5 W / 345 Lumen  
3.000 Kelvin

**956-5736**



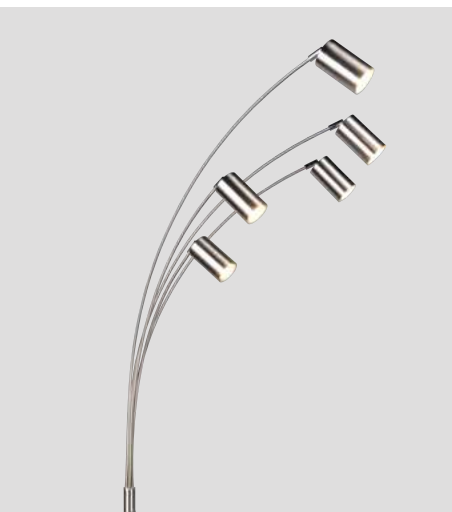

Metall · metal

- 07** | Nickel matt · nickel mat
- 08** | Messing matt · brass mat
- 31** | Weiß matt · white mat
- 32** | Schwarz matt · black mat

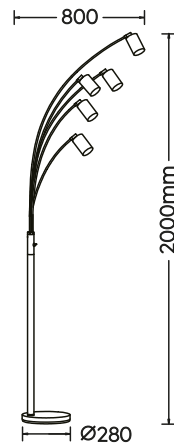

Stehleuchte · Floor lamp  
excl. 5 x GU10  
max. 10 W

**412400507 NEW**  
**412400532 NEW**



# DAKOTA

Diese klassische Stehleuchte vereint zeitloses Design mit hoher Funktionalität. Ihr elegantes Erscheinungsbild macht sie zu einem dekorativen Highlight in jedem Raum.

This classic floor lamp combines timeless design with high functionality. Its elegant appearance makes it a decorative highlight in any room.



Metall · metal



32 | Schwarz matt · black mat



Stehleuchte · Floor lamp

excl. 3 x G9  
max. 28 W

404600332



Diese elegante Stehleuchte, kombiniert mit einer passenden Wandleuchte, bietet eine praktische und stilvolle Beleuchtungslösung für Ihr Schlafzimmer. Die Stehleuchte sorgt für angenehmes Licht im Raum, während die Wandleuchte ideal neben dem Bett platziert werden kann.

This elegant floor lamp, combined with a matching wall light, offers a practical and stylish lighting solution for your bedroom. The floor lamp provides pleasant light in the room, while the wall lamp is ideal for placing next to the bed.

# EDWARD



Metall · metal

32 | Schwarz matt · black mat

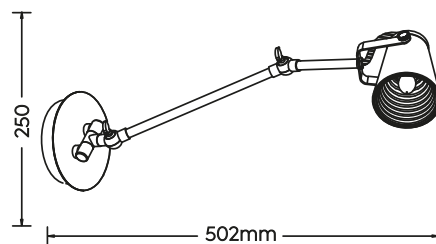

Wandleuchte · Wall lamp

excl. 1 x E14  
max. 40 W

208870132

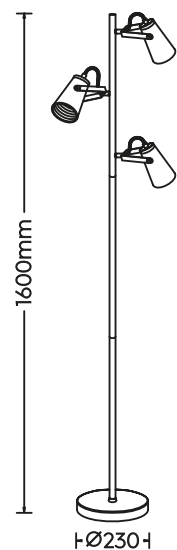
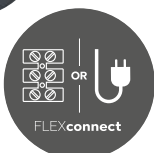

Stehleuchte · Floor lamp

excl. 3 x E14  
max. 40 W

408800332



# TEXEL

Mit seiner klassischen Farbgebung in Schwarz-Gold strahlt TEXEL Eleganz und Beständigkeit aus, ideal für eine gehobene Einrichtung.

With its classic black and gold colour scheme, TEXEL exudes elegance and durability, ideal for upmarket interiors.

Metall · metal



79 | goldfarbig · gold



## SWITCH DIMMER

Helligkeit in 3 Stufen mit herkömmlichem Lichtschalter einstellbar.

Brightness adjustable in 4 levels with conventional light switch.



Stehleuchte · Floor lamp

incl. SMD-LED  
15 W / 1.450 Lumen  
3.000 Kelvin

474410179



# SEEKER NEW

Diese puristische Stehleuchte vereint schlichte Eleganz mit hoher Funktionalität und ist ein stilvolles Highlight in jedem Raum.

This purist floor lamp combines simple elegance with high functionality and is a stylish highlight in any room.

Metall, Kunststoff · metal, plastic

● 32 | Schwarz matt · black mat

○ 76 | Warm Grau · warm grey



Lichtfarbe einstellbar ·  
Adjustable light color



Sensordimmer ·  
Sensor dimmer

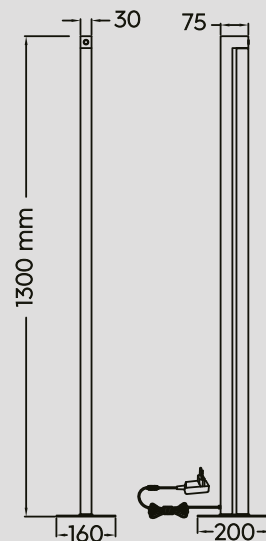

Stehleuchte · Floor lamp  
incl. SMD-LED  
22 W / 2.200 Lumen  
2.300 + 3.000 + 4.000 Kelvin  
448810132  
448810176



IP20

# NARCOS

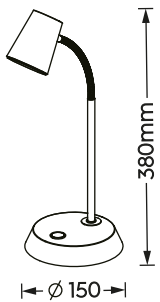

Tischleuchte · Table lamp  
incl. SMD-LED  
6,9 W / 660 Lumen  
3.000 Kelvin  
**573190107**



Stehleuchte · Floor lamp  
incl. SMD-LED  
3 x 6,9 W / 3 x 660 Lumen  
3.000 Kelvin  
**473190332**



Metall · metal

07 | Nickel matt · nickel mat

32 | Schwarz matt · black mat



# FILIGRAN

Das feine, lineare Design vereint Zurückhaltung und Eleganz, wodurch es sich harmonisch in jedes moderne Ambiente einfügt.

The fine, linear design combines restraint and elegance, allowing it to blend harmoniously into any modern ambience.



## Sensordimmer

Die Leuchte lässt sich mittels integriertem Sensordimmer stufenlos dimmen.

## Sensor dimmer

The light fitting has an integrated sensor dimmer for infinitely variable dimming.

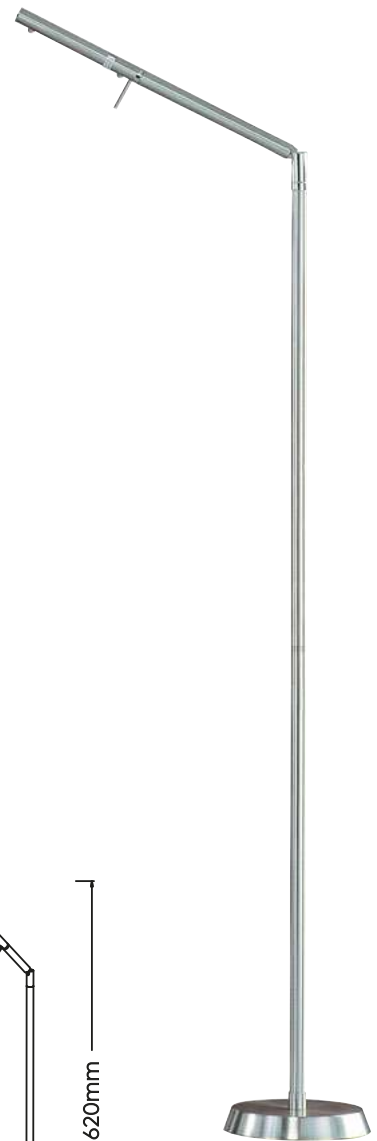

Stehleuchte · Floor lamp

incl. SMD-LED  
6,5 W / 700 Lumen  
3.000 Kelvin

420490107

420490132



Metall · metal

07 | Nickel matt · nickel mat

32 | Schwarz matt · black mat

# BERGAMO

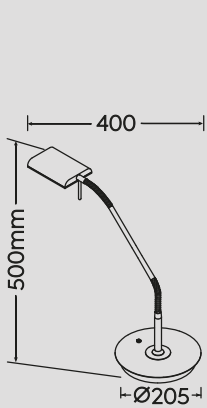

Tischleuchte · Table lamp

incl. SMD-LED  
12 W / 1.100 Lumen  
3.000 Kelvin

520910107  
520910108

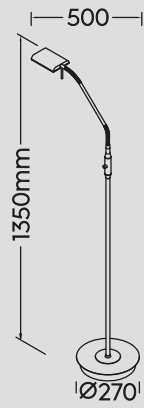

Stehleuchte · Floor lamp

incl. SMD-LED  
12 W / 1.100 Lumen  
3.000 Kelvin

420910107  
420910108

Metall · metal

07 | Nickel matt · nickel mat

08 | Messing matt · brass mat



# VERONA

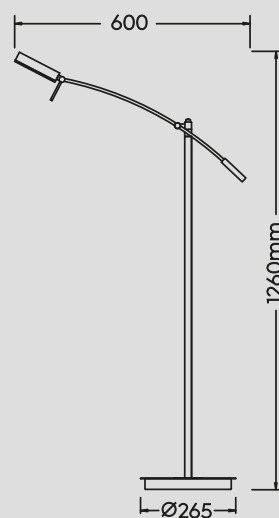
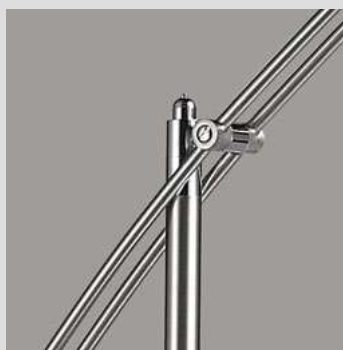

Metall · metal

07 | Nickel matt · nickel mat

Stehleuchte · Floor lamp  
incl. SMD-LED  
12 W / 1.100 Lumen  
3.000 Kelvin  
420810107



# MONZA

Dezentes Design und maximaler Lichtkomfort! Die Leuchten verfügen über einen Sensordimmer, mit dem die Helligkeit sowie die Lichtfarbe stufenlos angepasst werden können.

Discreet design and maximum lighting comfort! The lights have a sensor dimmer with which the brightness and light colour can be continuously adjusted.



Lichtfarbe einstellbar ·  
Adjustable light color



Sensordimmer ·  
Sensor dimmer



Memory Funktion ·  
Memory function

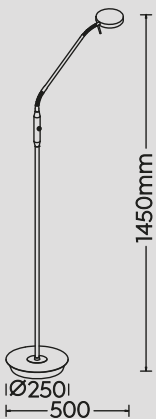
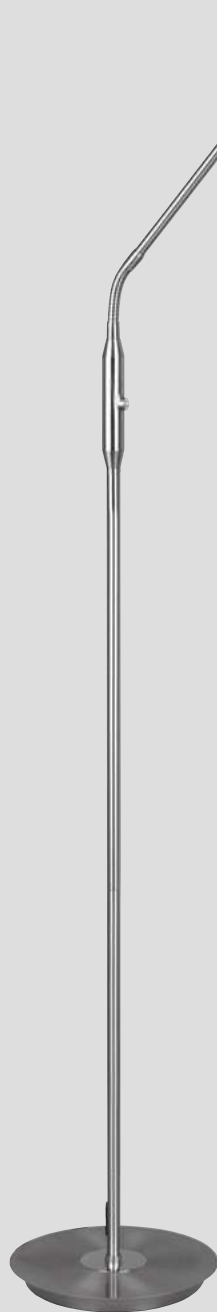

Stehleuchte · Floor lamp

incl. SMD-LED  
12 W / 1.400 Lumen  
2.300 + 3.000 + 4.000 Kelvin

423310107  
423310108  
423310131  
423310132

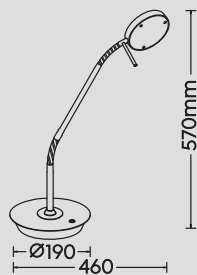

Tischleuchte · Table lamp

incl. SMD-LED  
12 W / 1.400 Lumen  
2.300 + 3.000 + 4.000 Kelvin

523310107  
523310108  
523310131  
523310132



IP20



IP20

Metall · metal



07 | Nickel matt · nickel mat



08 | Messing matt · brass mat



31 | Weiß matt · white mat



32 | Schwarz matt · black mat



# NORRIS NEW

Diese Leuchten vereinen minimalistisches Design mit praktischer Funktionalität. Die Kombination aus natürlichem Holz und klassischem Schwarz oder zurückhaltendem Weiß schafft eine zeitlose Ästhetik.

These lights combine minimalist design with practical functionality. The combination of natural wood and classic black or understated white creates a timeless aesthetic.



3 Helligkeitsstufen mit Touchfunktion ·  
3 brightness levels with touch function

Metall, Holz naturbelassen ·  
metal, wood natural finish

   31 | Weiß matt · white mat

   32 | Schwarz matt · black mat

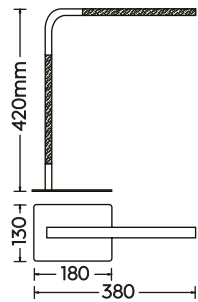

Tischleuchte · Table lamp

incl. SMD-LED  
7 W / 950 Lumen  
3.000 Kelvin

545210131  
545210132

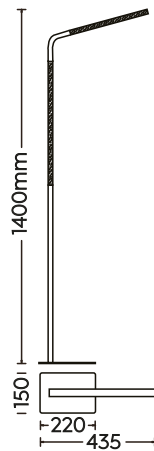

Stehleuchte · Floor lamp

incl. SMD-LED  
11 W / 1.400 Lumen  
3.000 Kelvin

445210131  
445210132



3 Helligkeitsstufen ·  
3 brightness levels



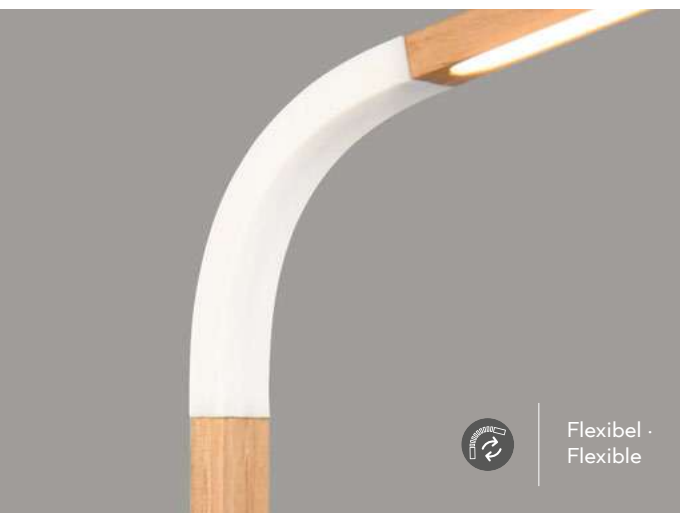

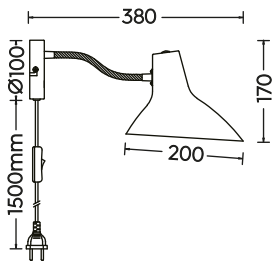

Wandleuchte · Wall lamp

excl. 1 x E27  
max. 10 W

263470176  
263470180

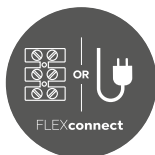

Diese Wandleuchte ist sowohl für den Festanschluss,  
als auch für den Betrieb mit Steckerzuleitung geeignet.

This wall light is suitable both for a fixed power connection,  
as well as for the connection of a plug-in power cable.





# TRAVELLER NEW

Klassisches Schwarz oder sanftes Warm Grey - egal für welche Farbe man sich entscheidet, die Leuchten aus der Serie TRAVELLER sind ein absoluter Hingucker und ein stilvolles Accessoire für jedes Zuhause.

Classic black or soft warm grey - no matter which colour you choose, the lights from the TRAVELLER range are an absolute eye-catcher and a stylish accessory for any home.



- Metall · metal
- 76** | Warm Grau · warm grey
  - 80** | Schwarz-Gold · black-gold

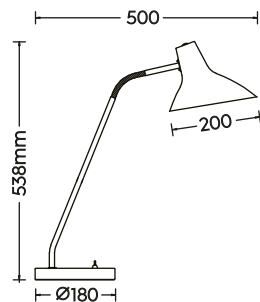

Tischleuchte · Table lamp  
excl. 1 x E27  
max. 10 W  
**563400176**  
**563400180**

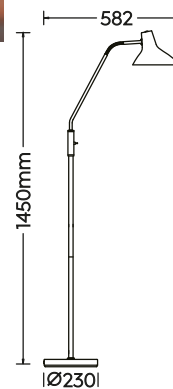

Stehleuchte · Floor lamp  
excl. 1 x E27  
max. 10 W  
**463400176**  
**463400180**



# TRACY



Metall, Stoffschirm ·  
metal, fabric shade



32 | Schwarz matt · black mat

Stehleuchte · Floor lamp

excl. 1 x E27

max. 60 W

462100132

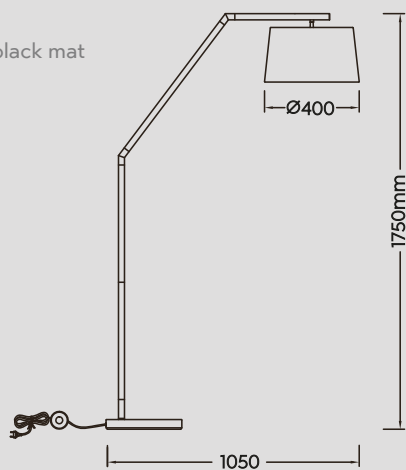

# MANSUR



Metall, Stoffschirm ·  
metal, fabric shade



**31** | Weiß matt, Schirm Grau ·  
white mat, shade grey



**41** | Taupe, Schirm innen goldfarbig, Metall Schwarz matt ·  
taupe, shade gold colored inside, metal black mat

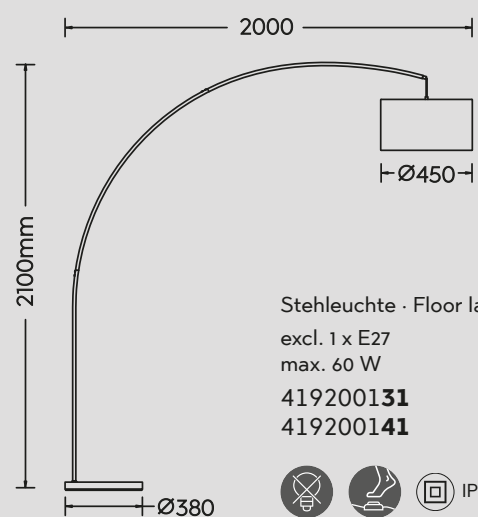

Stehleuchte · Floor lamp

excl. 1 x E27  
max. 60 W

4192001**31**

4192001**41**



IP20

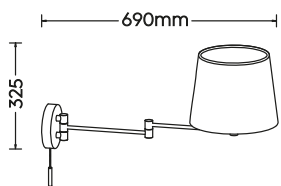
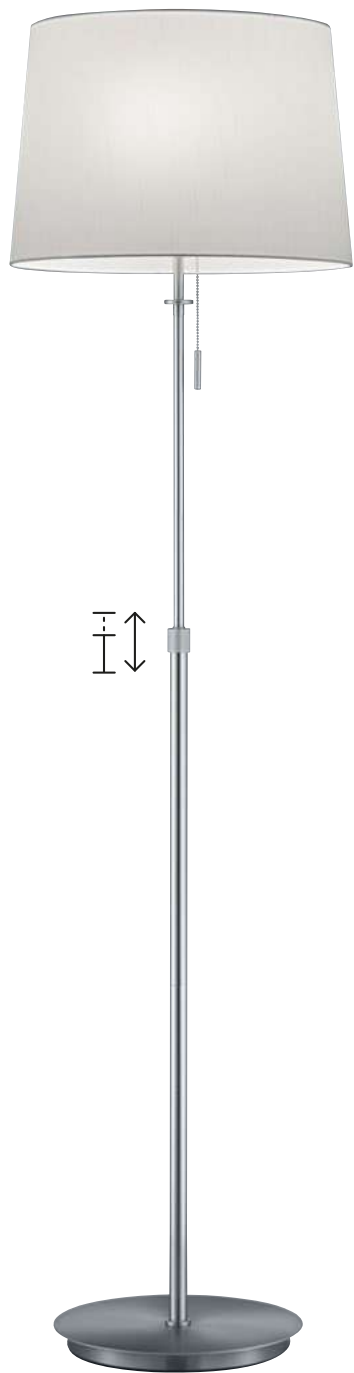

Wandleuchte · Wall lamp  
 excl. 1 x E27  
 max. 60 W  
**209100107**  
**209100108**

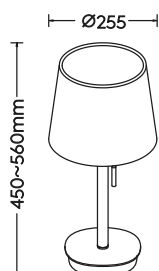

Tischleuchte · Table lamp  
 excl. 1 x E27  
 max. 60 W  
**509100107**  
**509100108**

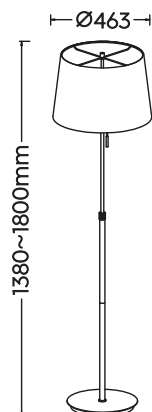

Stehleuchte · Floor lamp  
 excl. 3 x E27  
 max. 60 W  
**409100307**  
**409100308**





# LYON

Ob im Wohnzimmer, Schlafzimmer oder Büro – dieser Klassiker mit edlem Stoffschirm ist die perfekte Wahl für alle, die Wert auf Stil und Funktionalität legen.

Whether in the living room, bedroom or office - this classic with its elegant fabric shade is the perfect choice for anyone who values style and functionality.

Metall, Stoffschirm Weiß ·  
metal, fabric shade white



**07** | Nickel matt · nickel mat



**08** | Messing matt · brass mat



# CASSIO

Ob als Stehleuchte neben dem Sofa oder als Tischleuchte auf der Kommode, die CASSIO-Serie fügt sich harmonisch in verschiedene Wohnstile ein und setzt dekorative Akzente.

Whether as a floor lamp next to the sofa or as a table lamp on a chest of drawers, the CASSIO series blends harmoniously into different living styles and sets decorative accents.

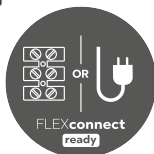

Metall, Stoff Weiß · metal, fabric white

 **08** | Messing matt · brass mat

 **32** | Schwarz matt · black mat

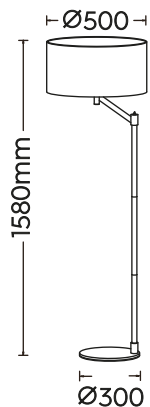

Stehleuchte · Floor lamp

excl. 1 x E27  
max. 60 W

414400108  
414400132

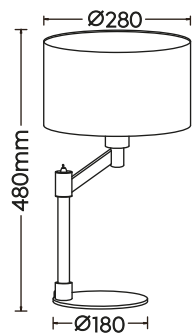

Tischleuchte · Table lamp

excl. 1 x E27  
max. 60 W

514400108  
514400132

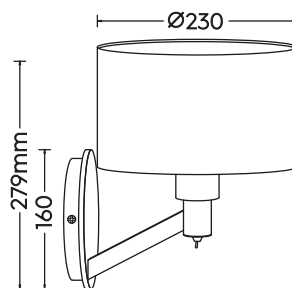

Wandleuchte · Wall lamp

excl. 1 x E27  
max. 40 W

214470108  
214470132





# PARIS II

Diese eleganten Leuchten bieten ästhetischen Charme. Der hochwertige Stoffschirm sorgt für eine weiche, diffuse Beleuchtung, die jeden Raum in ein warmes und einladendes Licht taucht.

These elegant lights offer aesthetic charm. The high-quality fabric shade provides soft, diffuse lighting that bathes any room in a warm and inviting light.

Metall, Stoff Weiß · metal, fabric white

 **07** | Nickel matt · nickel mat

 **08** | Messing matt · brass mat

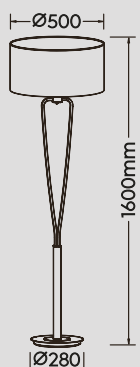

Stehleuchte · Floor lamp

excl. 1 x E27  
max. 60 W

4002001**07**  
4002001**08**

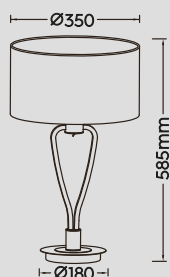

Tischleuchte · Table lamp

excl. 1 x E27  
max. 60 W

5002001**07**  
5002001**08**





# NANDOR

Diese eleganten Leuchten vereinen stilvolles Design mit fortschrittlicher Technologie. Der Stoffschirm bietet eine angenehme, diffuse Beleuchtung, während die LED-Akzentbeleuchtung im Standfuß für zusätzliche Atmosphäre sorgt.

These elegant lights combine stylish design with advanced technology. The fabric shade provides pleasant, diffuse lighting, while the LED accent lighting in the base provides additional atmosphere.

Metall, Stoff · metal, fabric

07 | Nickel matt · nickel mat

79 | goldfarbig · gold

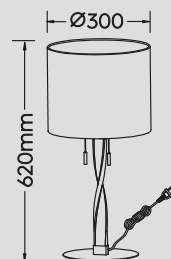
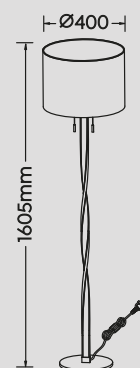

Tischleuchte · Table lamp

incl. 2 x SMD-LED  
3 W / 2 x 300 Lumen  
3.000 Kelvin  
excl. 1 x E27  
max. 40 W

575310307

575310379



Stehleuchte · Floor lamp

incl. 2 x SMD-LED  
7 W / 2 x 700 Lumen  
3.000 Kelvin  
excl. 1 x E27  
max. 60 W

475310307

475310379



# CLAAS

Die Stehleuchte verfügt über eine praktische Ablagefläche und einen USB, sowie USB-C Anschluss mit Ladefunktion. So bietet es sich beispielsweise an, das Smartphone neben dem Sofa abzulegen und gleichzeitig aufzuladen.

The floor lamp has a practical storage surface and a USB and USB-C port with charging function. For example, you can place your smartphone next to the sofa and charge it at the same time.



Metall, Stoff Grau · metal, fabric grey

07 | Nickel matt · nickel mat

32 | Schwarz matt · black mat

Stehleuchte · Floor lamp

excl. 1 x E27

max. 60 W

400400107

400400132

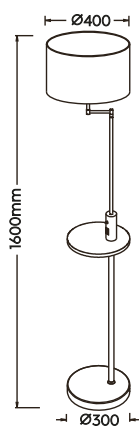

USB und USB-C Anschluss mit Ladefunktion ·  
Recharging USB and USB-C connection

# HOTEL



Metall, Stoffschirm · metal, fabric shade

-  **01** | Weiß · white
-  **08** | Messing matt · brass mat
-  **11** | Grau · grey

Stehleuchte · Floor lamp

excl. 1 x E27

max. 60 W

excl. 1 x E14

max. 18 W

**403900201**

**403900208**

**403900211**

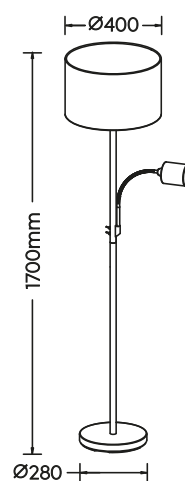

# ELIO NEW

Der transparente Glasfuß verleiht der Leuchte eine leichte und moderne Optik, während der Stoffschirm für eine warme und gemütliche Lichtverteilung sorgt.

The transparent glass base gives the luminaire a light and modern look, while the fabric shade ensures a warm and cosy light distribution.

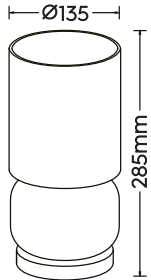

Tischleuchte · Table lamp

excl. 1 x E27  
max. 40 W

517800113

517800115

517800154



Glas, Metall, Stoffschirm Schwarz ·  
glass, metal, fabric shade black

- 13 | Amber · amber
- 15 | Grün · green
- 54 | rauchfarbig · smoke

# VELA NEW

Die modischen Farboptionen bieten die Möglichkeit, die Tischleuchte perfekt an den Einrichtungsstil des Raumes anzupassen.

The fashionable colour options make it possible to perfectly match the table lamp to the interior style of the room.

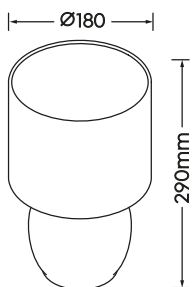

Tischleuchte · Table lamp

excl. 1 x E14  
max. 10 W

517900111

517900112

517900113

517900115



Glas, Stoffschirm weiß ·  
glass, fabric shade white

- 11 | Grau · grey
- 12 | Blau · blue
- 13 | Amber · amber
- 15 | Grün · green



# MATS II



## On/Off Touch Funktion

Diese Leuchte lässt sich durch Berührung Ein- und Ausschalten.

## On/Off Touch function

This light fitting has a touch switch for on-off switching.

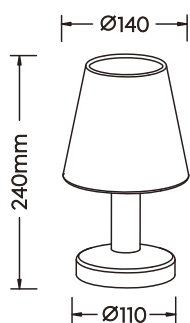

Tischleuchte · Table lamp

excl. 1 x E14  
max. 40 W

599700101

599700115

599700119

599700142

Metall Nickel matt, Stoff ·  
metal nickel mat, fabric



01 | Weiß · white



15 | Grün · green



19 | Türkis · turquoise



42 | Anthrazit · anthracite







# BALE

Zeitlos, geradlinig, schlicht und elegant! Sanfte, frische Farbtöne wie Pistaziengrün und leuchtendes Gelb vermitteln ein sonniges Gefühl und entsprechen dem Wunsch nach Wohnlichkeit und Entspannung. Die zusätzliche Beleuchtung im Fuß werdet die Lichtstimmung zusätzlich auf und sorgt für das gewisse Etwas.

Timeless, straightforward, simple and elegant! Soft, fresh colours such as pistachio green and bright yellow convey a sunny feeling and meet the desire for cosiness and relaxation. The additional lighting in the base further enhances the lighting mood and adds that certain something.



Stoff · fabric

-  12 | Blau · blue
-  49 | Pistaziengrün · pistachio green
-  77 | Ultimate Grau · ultimate grey
-  83 | Illuminate Gelb · illuminate yellow

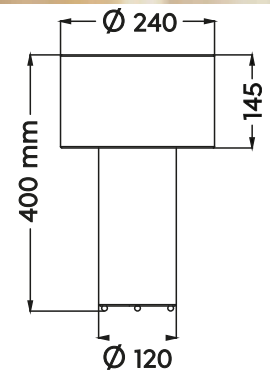

Tischleuchte · Table lamp

excl. 2 x E27  
max. 10 W

505200112

505200149

505200177

505200183



# NOLA

Die Tischleuchte NOLA besticht durch ihre puristische und klassisch inspirierte Form. Ihr modernes, pilzförmiges Design fügt sich nahtlos in jedes Interieur ein und schafft eine harmonische Atmosphäre.

The NOLA table lamp impresses with its purist and classically inspired shape. Its modern, mushroom-shaped design blends seamlessly into any interior and creates a harmonious atmosphere.

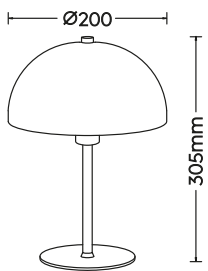

Tischleuchte · Table lamp  
excl. 1 x E14  
max. 28 W  
506200131  
506200132

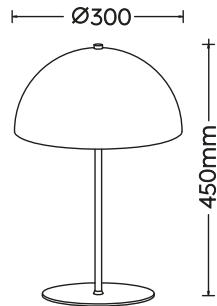

Tischleuchte · Table lamp  
excl. 1 x E27  
max. 40 W  
506290131  
506290132



Metall · metal

31 | Weiß matt · white mat

32 | Schwarz matt · black mat



# NUBIAN NEW

Diese Tischleuchte überzeugt durch ihre klassische und zurückhaltende Form. Die trendigen Farbtöne machen sie zu einem stilvollen Accessoire.

This table lamp impresses with its classic and understated shape. The trendy colour tones make it a stylish accessory.

Metall · metal

-  **32** | Schwarz matt · black mat
-  **44** | Beige · fawn
-  **65** | Coffee · coffee

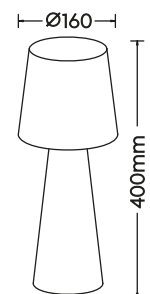

Tischleuchte · Table lamp

excl. 1 x E27  
max. 10 W

5629001**32**

5629001**44**

5629001**65**



IP20

# BOCCIA NEW

Erhältlich in poliertem Chrom oder Messing, fügt sie sich nahtlos in verschiedene Einrichtungsstile ein. Ihre dekorative Gestaltung macht sie nicht nur zu einer praktischen Lichtquelle, sondern auch zu einem stilvollen Accessoire.

Available in polished chrome or brass, it blends seamlessly into various interior styles. Its decorative design makes it not only a practical light source, but also a stylish accessory.

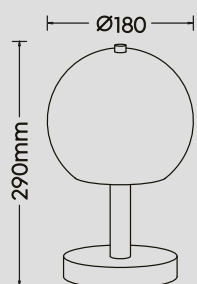

Tischleuchte · Table lamp

excl. 1 x E27  
max. 10 W

519300103

519300106



Metall · metal



03 | Messing poliert · polished brass



06 | Chrome · chrome



# STEEN NEW

Diese dekorative Tischleuchte beeindruckt mit ihrem markanten Glasschirm, der jedem Raum eine besondere Note verleiht und für eine gleichmäßige Lichtverteilung sorgt.

This decorative table lamp impresses with its striking glass shade, which adds a special touch to any room and ensures even light distribution.



Metall, Glas · metal, glass

-  **32** | Schwarz matt · black mat
-  **65** | Coffee · coffee
-  **76** | Warm Grau · warm grey

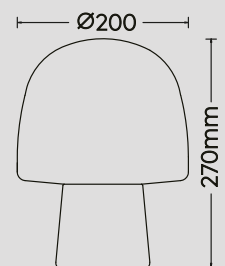

Tischleuchte · Table lamp

excl. 1 x E14  
max. 10 W

**568200132**

**568200165**

**568200176**



# DONNA

Metall, Glas alabasterfarbig ·  
metal, alabaster-coloured glass

07 | Nickel matt · nickel mat

08 | Messing matt · brass mat

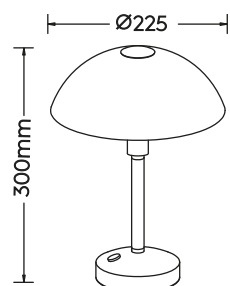

Tischleuchte · Table lamp

incl. SMD-LED

4,5 W / 450 Lumen

3.000 Kelvin

525790107

525790108



# BERLIN

Metall, Glas matt · metal, mat glass

07 | Nickel matt · nickel mat

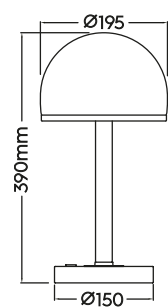

Tischleuchte · Table lamp

incl. SMD-LED

4,5 W / 450 Lumen

3.000 Kelvin

527590107





# JOOST II

Metall, Glas matt · metal, mat glass

07 | Nickel matt · nickel mat

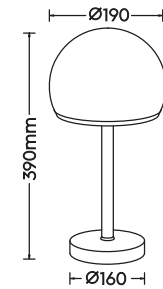

Tischleuchte · Table lamp

excl. 1 x E27

max. 40 W

592300107



# VENTURA

Metall, Glas matt · metal, mat glass

03 | Messing poliert · polished brass

07 | Nickel matt · nickel mat

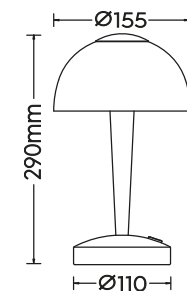

Tischleuchte · Table lamp

incl. SMD-LED

4 W / 350 Lumen

3.000 Kelvin

529990103

529990107



# LUIS II



Empfohlen:  
recommended:

LED E14  
4,9 W / 470 Lumen  
3.000 Kelvin

**983-66**

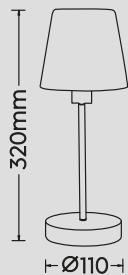

Tischleuchte · Table lamp

excl. 1 x E14  
max. 40 W

**595700106**

**595700107**

**595700108**



Metall, Glas alabasterfarbig ·  
metal, alabaster-coloured glass



**06** | Chrome · chrome



**07** | Nickel matt · nickel mat



**08** | Messing matt · brass mat

# EMERALD

Metall, Glas matt · metal, mat glass



**06** | Chrome · chrome



**07** | Nickel matt · nickel mat

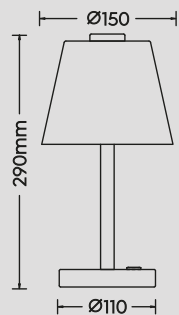

Tischleuchte · Table lamp

incl. SMD-LED  
4,5 W / 450 Lumen  
3.000 Kelvin

**525490106**

**525490107**



# FYNN II

Diese vielseitige Tischleuchte ist der perfekte Begleiter für jeden Raum. Mit ihrer praktischen Touchfunktion lässt sie sich mühelos ein- und ausschalten.

This versatile table lamp is the perfect companion for any room. With its practical touch function, it can be switched on and off effortlessly.



06



08



18

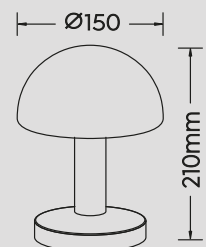

Empfohlen:  
recommended:

LED E14  
4,9 W / 470 Lumen  
3.000 Kelvin

**983-66**



Metall, Glas alabasterfarbig ·  
metal, alabaster-coloured glass



**06** | Chrome · chrome



**07** | Nickel matt · nickel mat



**08** | Messing matt · brass mat



**18** | Orange · orange

Tischleuchte · Table lamp

excl. 1 x E14  
max. 40 W

**599100106**

**599100107**

**599100108**

**599100118**



IP20

# TILL II



Empfohlen:  
recommended:

LED E14  
4,9 W / 470 Lumen  
3.000 Kelvin

**983-66**

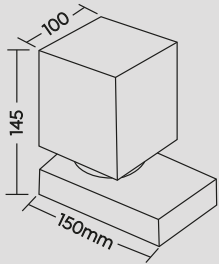

Tischleuchte · Table lamp

excl. 1 x E14

max. 40 W

**590200107**

**590200132**



Metall, Glas matt · metal, mat glass



**07** | Nickel matt · nickel mat



**32** | Schwarz matt · black mat

# DAVI II

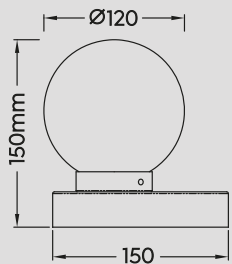

Tischleuchte · Table lamp

excl. 1 x E14

max. 40 W

**590100107**

**590100132**

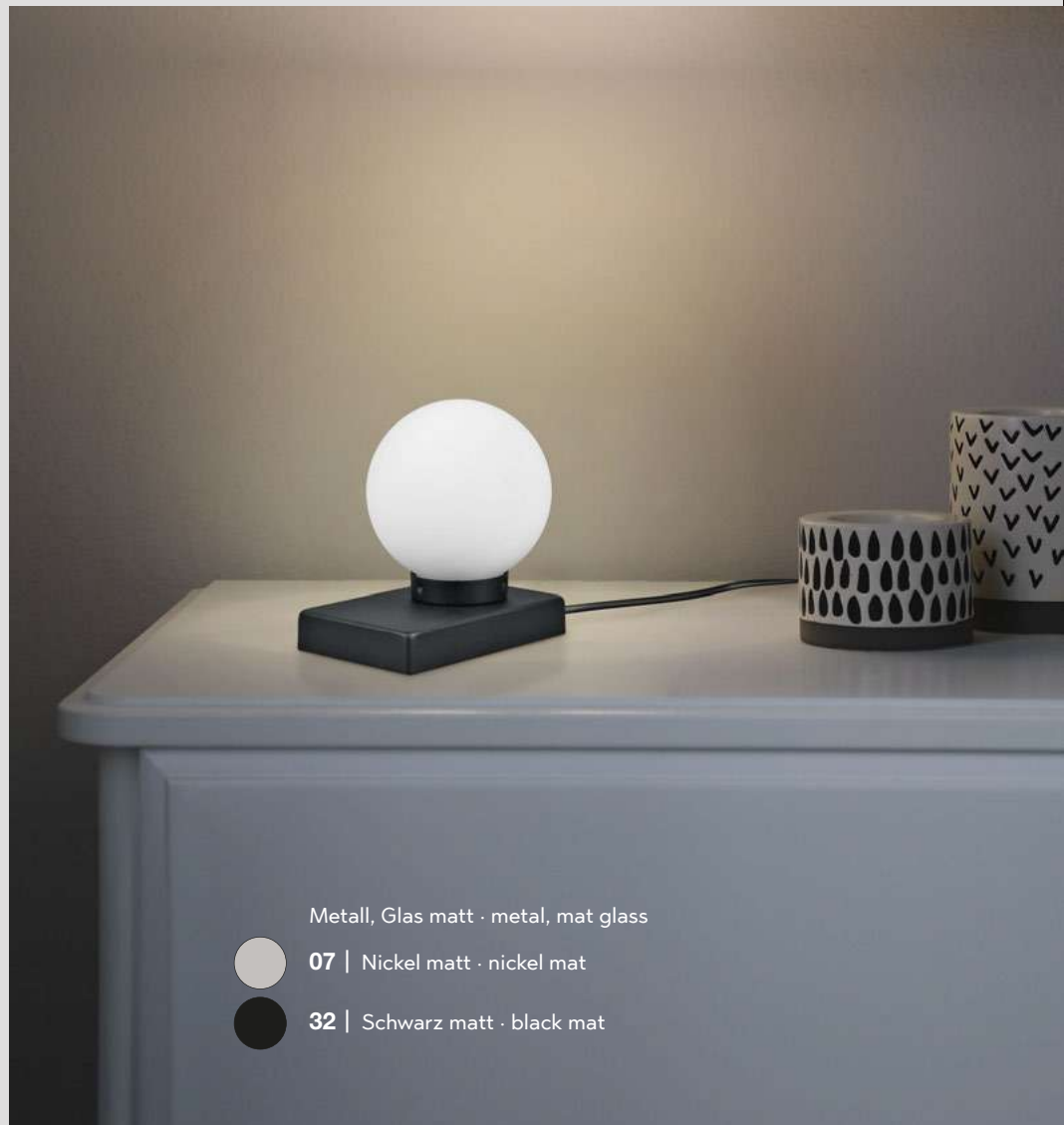

Metall, Glas matt · metal, mat glass



**07** | Nickel matt · nickel mat



**32** | Schwarz matt · black mat



# CRISTO

Metall Chrom, Kristallglas ·  
metal chrome, crystal glass

○ 00 | Transparent · transparent

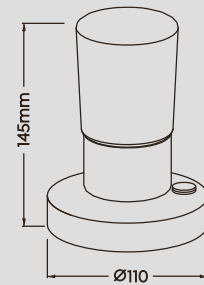

Tischleuchte · Table lamp  
incl. OSRAM-LED  
4,3 W / 430 Lumen  
3.000 Kelvin  
**529690100**



# ARY II



Metall, Glas matt · metal, mat glass

○ 07 | Nickel matt · nickel mat

● 32 | Schwarz matt · black mat

Empfohlen:  
recommended:



LED E14  
4,9 W / 470 Lumen  
3.000 Kelvin  
**983-66**

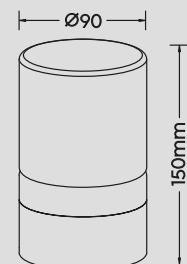

Tischleuchte · Table lamp  
excl. 1 x E14  
max. 40 W  
**591000107**  
**591000132**



# TRAVIS NEW

Eine Schreibtischleuchte, die sowohl dimmbar ist als auch eine einstellbare Lichtfarbe bietet. Besonders praktisch ist der integrierte USB und USB-C Anschluss mit Ladefunktion, der es ermöglicht, elektronische Geräte direkt am Arbeitsplatz aufzuladen.

A desk lamp that is both dimmable and offers an adjustable light colour. The integrated USB and USB-C connection with charging function is particularly practical, allowing electronic devices to be charged directly at the workstation.



USB und USB-C Anschluss mit Ladefunktion · Recharging USB and USB-C connection



Lichtfarbe einstellbar · Adjustable light color



Integrierter Dimmer · Integrated dimmer



Memory Funktion · Memory function

Metall · metal



**31** | Weiß matt · white mat



**32** | Schwarz matt · black mat

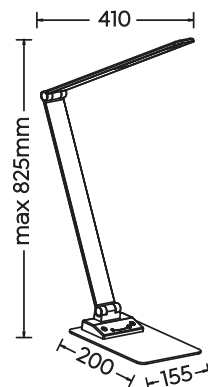

Tischleuchte · Table lamp  
incl. SMD-LED  
6,5 W / 650 Lumen  
3.000 + 5.000 + 6.500 Kelvin  
**545310131**  
**545310132**



IP20



# MANDURO NEW

Egal, ob Sie konzentriert arbeiten oder entspannt lesen möchten – mit der regelbaren Helligkeit und den einstellbaren Lichtfarben bietet diese Schreibtischleuchte stets die perfekte Beleuchtung.

Whether you want to concentrate on your work or relax and read - with its adjustable brightness and adjustable light colours, this desk lamp always provides the perfect lighting.



Lichtfarbe stufenlos einstellbar ·  
Light color infinitely variable



Sensordimmer ·  
Sensor dimmer



Metall · metal



**31** | Weiß matt · white mat



**32** | Schwarz matt · black mat

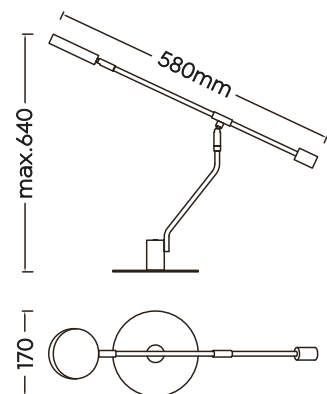

Tischleuchte · Table lamp

incl. SMD-LED

6 W / 560 Lumen

2.700 + 4.000 + 6.500 Kelvin

**549010131**

**549010132**



IP20

# AVA

AVA bietet maximale Flexibilität und Komfort. Mit ihrer dimmbaren Lichtquelle lässt sich die Helligkeit ganz nach Ihren Bedürfnissen anpassen. Zudem lässt sich die Lichtfarbe individuell einstellen.

AVA offers maximum flexibility and comfort. With its dimmable light source, the brightness can be adjusted to suit your needs. The light colour can also be individually adjusted.



Lichtfarbe einstellbar ·  
Adjustable light color



Sensordimmer ·  
Sensor dimmer



Memory Funktion ·  
Memory function



Tischleuchte · Table lamp  
incl. SMD-LED  
5,2 W / 600 Lumen  
3.000 + 4.000 + 6.500 Kelvin  
**523090131**  
**523090132**



IP20

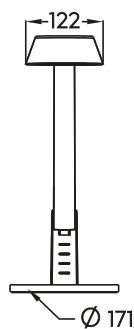
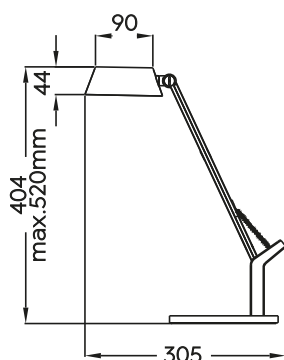

Kunststoff · plastic



**31** | Weiß matt · white mat



**32** | Schwarz matt · black mat

# AMSTERDAM

Die Schreibtischleuchte AMSTERDAM ist ein wahres Multitalent. Sie kann flexibel eingesetzt werden und bietet verschiedene Montagemöglichkeiten. Dank der mitgelieferten Klemmvorrichtung und Wandhalterung lässt sich die Leuchte entweder direkt an der Wand oder an der Tisch- oder Regalkante befestigen. Alternativ kann sie auch ganz einfach auf dem Schreibtisch platziert werden.

The AMSTERDAM desk lamp is a true all-rounder. It can be used flexibly and offers various mounting options. Thanks to the clamping device and wall bracket supplied, the light can be attached either directly to the wall or to the edge of a table or shelf. Alternatively, it can simply be placed on the desk.



Metall · metal

01 | Weiß · white

02 | Schwarz · black

Tischleuchte · Table lamp  
incl. SMD-LED  
5 W / 500 Lumen  
3.000 Kelvin  
527920101  
527920102

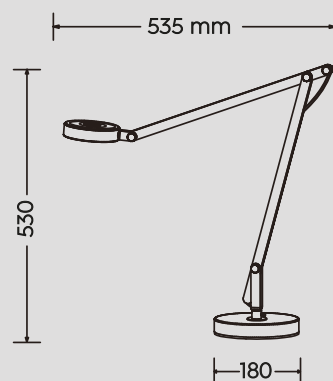

# POLO

Die schlanke Form und die integrierte Touch-Funktion, die es ermöglicht, die Helligkeit und die Lichtfarbe bequem zu regulieren, machen die Tischleuchte POLO zu einem diskreten und wirkungsvollen Lichtspender.

The slim shape and the integrated touch function, which allows the brightness and light colour to be conveniently adjusted, make the POLO table lamp a discreet and effective source of light.



Lichtfarbe einstellbar ·  
Adjustable light color



4 fach TOUCH ·  
4 level Touch function

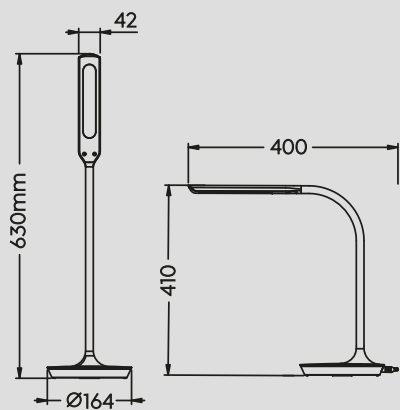
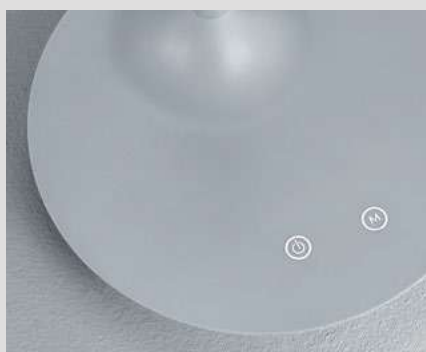

Tischleuchte · Table lamp

incl. SMD-LED

5 W / 550 Lumen

3.000 + 4.000 + 5.000 Kelvin

527090111

527090131



IP20

Kunststoff · plastic



11 | Grau · grey



31 | Weiß matt · white mat



# LUPO

Lesen, Basteln oder Reparieren von Kleinteilen - die Tischleuchte LUPO sorgt für ausreichend Licht und die nötige Vergrößerung.

Reading, crafting or repairing small parts - the LUPO table lamp provides sufficient light and the necessary magnification.



4 fach TOUCH ·  
4 level Touch function



Vergrößerung 3x ·  
Magnification 3x

Kunststoff · plastic



01 | Weiß · white



02 | Schwarz · black

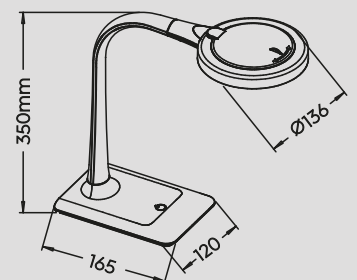
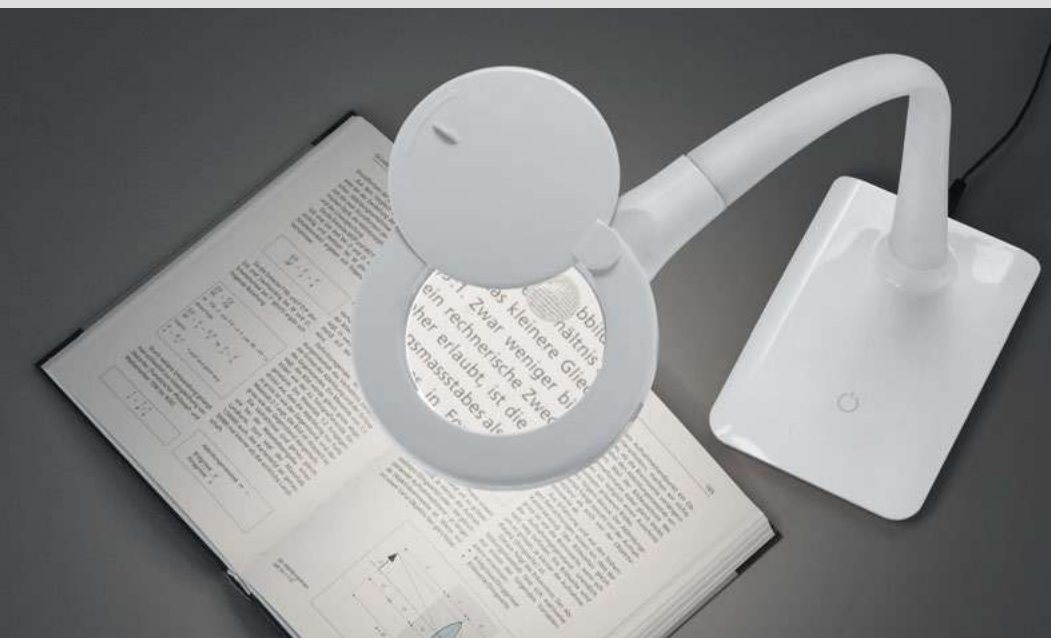

Tischleuchte · Table lamp

incl. SMD-LED  
5 W / 550 Lumen  
3.500 Kelvin

527290101

527290102



# PERRY

Dank ihres zeitlosen, schlanken Designs und des verstellbaren Flexarms ist diese Leuchte äußerst platzsparend und vielseitig einsetzbar.

Thanks to its timeless, slim design and adjustable flex arm, this luminaire is extremely space-saving and versatile.

Metall · metal

 **04** | Altmessing · old brass

 **07** | Nickel matt · nickel mat

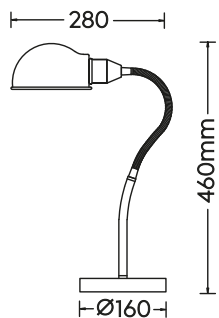

Tischleuchte · Table lamp

excl. 1 x E27  
max. 10 W

504900104

504900107





# CURTIS

Ein Hingucker auf ganzer Linie - Das klassische Design, sowie der verstellbare Flexarm machen diese Leuchte zu einem echten Schmuckstück.

An eye-catcher all along the line - The classic design and the adjustable flexible arm make this light a real piece of jewellery.



Metall · metal

-  **04** | Altmessing · old brass
-  **07** | Nickel matt · nickel mat
-  **08** | Messing matt · brass mat
-  **32** | Schwarz matt · black mat



Tischleuchte · Table lamp

incl. SMD-LED  
4 W / 430 Lumen  
3.000 Kelvin

**579790104**  
**579790107**  
**579790108**  
**579790132**

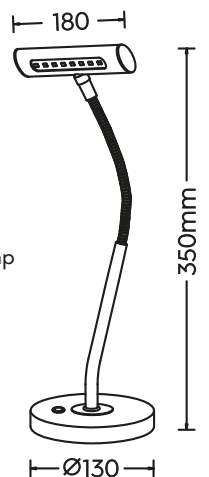

# PRONTO



Metall, Kunststoff · metal, plastic



01 | Weiß · white



17 | mehrfarbig · multicolor



47 | silberfarbig · silver-coloured

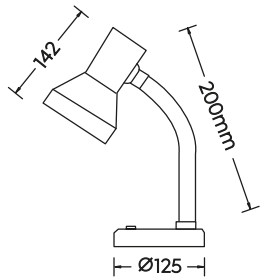

Tischleuchte · Table lamp

excl. 1 x E27  
max. 18 W

5027011-01

5027011-17

5027011-47





# TAJO

Metall · metal



**01** | Weiß · white



**47** | silberfarbig · silver-coloured

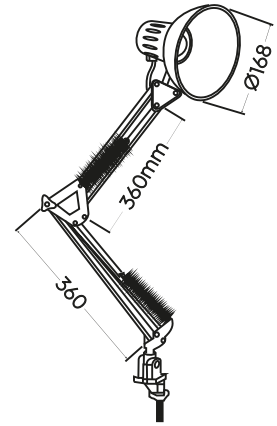

Tischleuchte · Table lamp

excl. 1 x E27

max. 40 W

**5029010-01**

**5029010-47**



IP20



# FLEXP

Metall, Kunststoff · metal, plastic



**01** | Weiß · white



**02** | Schwarz · black



**17** | mehrfarbig · multicolor



**47** | silberfarbig · silver-coloured

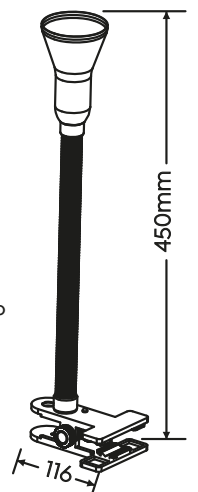

Tischleuchte · Table lamp

excl. 1 x E14

max. 18 W

**5028010-01**

**5028010-02**

**5028010-17**

**5028010-47**



IP20



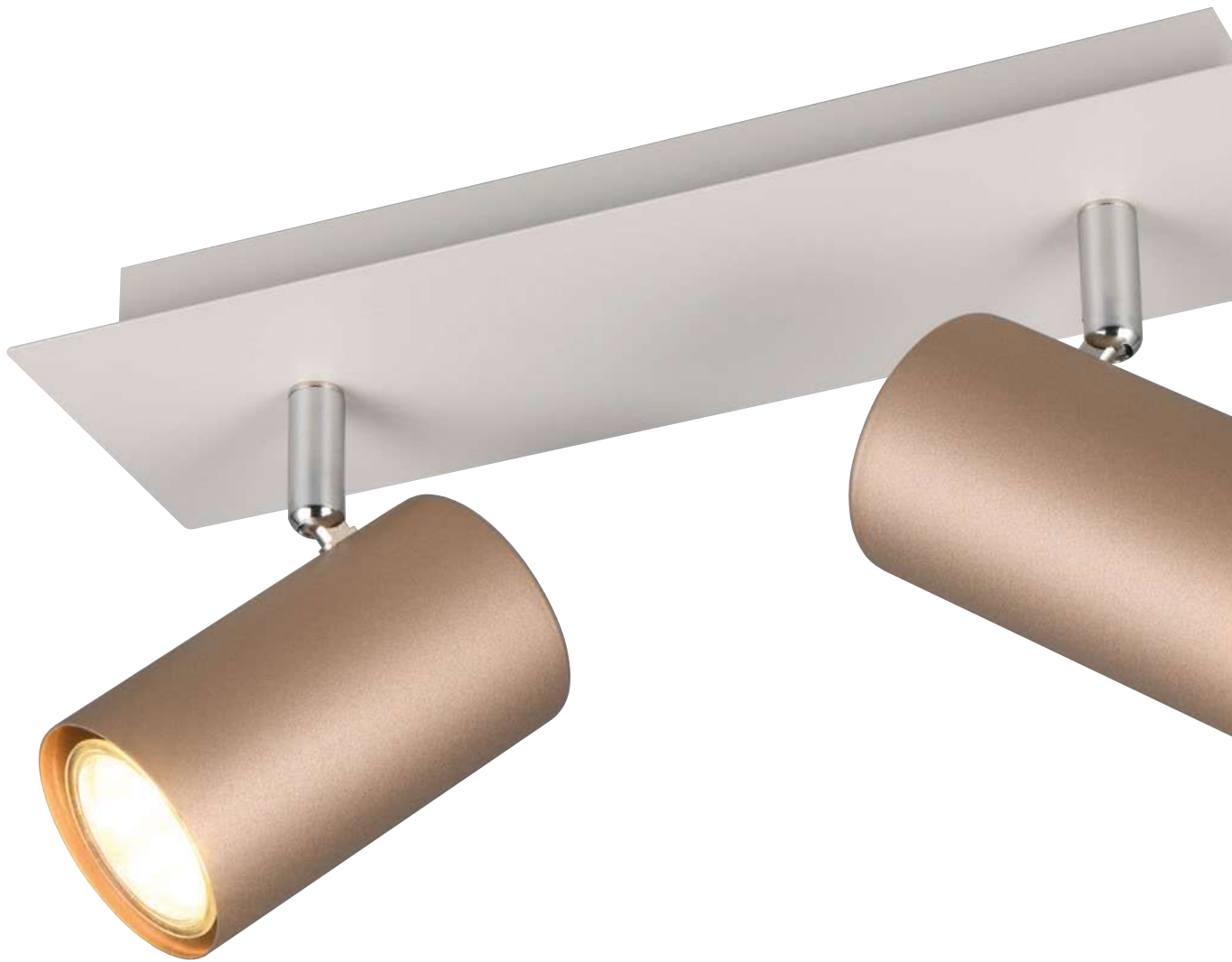

# SPOTS

Spotleuchten sind eine hervorragende Wahl, wenn es darum geht, bestimmte Bereiche oder Objekte gezielt zu beleuchten. Sie bieten eine flexible und fokussierte Lichtquelle, die sich ideal für Akzentbeleuchtung und Arbeitsbereiche eignet.

Spotlights are an excellent choice when it comes to illuminating specific areas or objects. They provide a flexible and focussed light source that is ideal for accent lighting and work areas.



#### SWITCH DIMMER

Helligkeit in 3 Stufen mit herkömmlichem Lichtschalter einstellbar.

Brightness adjustable in 4 levels with conventional light switch.



#### DIP SWITCH

Mittels DIP-SWITCH können drei Lichtfarben (Warmweiß, Neutralweiß, Universalweiß) über einen Schalter direkt an der Leuchte eingestellt werden.

The DIP SWITCH directly sets the luminaire's three light colours (warm, neutral and universal white).

Metall · metal



**31** | Weiß matt · white mat



**32** | Schwarz matt · black mat

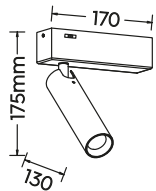

Strahler · Spot

incl. SMD-LED  
5,5 W / 500 Lumen  
2.300 + 3.000 + 4.000 Kelvin

**849210131**  
**849210132**

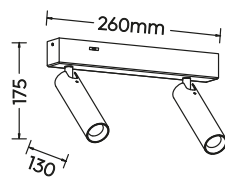

Strahler · Spot

incl. SMD-LED  
2 x 5,5 W / 2 x 500 Lumen  
2.300 + 3.000 + 4.000 Kelvin

**849210231**  
**849210232**

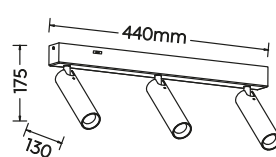

Strahler · Spot

incl. SMD-LED  
3 x 5,5 W / 3 x 500 Lumen  
2.300 + 3.000 + 4.000 Kelvin

**849210331**  
**849210332**

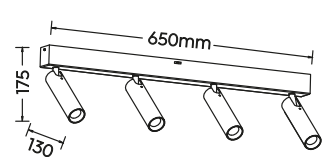

Strahler · Spot

incl. SMD-LED  
4 x 5,5 W / 4 x 500 Lumen  
2.300 + 3.000 + 4.000 Kelvin

**849210431**  
**849210432**





# AMBALA NEW

Diese Spotserie überzeugt durch ihre schlichte Formensprache und die gezielte Lichtverteilung. Die klaren Linien und das minimalistische Design fügen sich nahtlos in jede moderne Einrichtung ein. Dank der akzentuierten Lichtverteilung können bestimmte Bereiche oder Objekte im Raum perfekt in Szene gesetzt werden.

This spotlight series impresses with its simple design language and targeted light distribution. The clear lines and minimalist design blend seamlessly into any modern interior. Thanks to the accentuated light distribution, certain areas or objects in the room can be perfectly emphasised.



# TAURUS

Die Spotserie TAURUS zeichnet sich durch ihre Flexibilität in der Installation aus, da sie sowohl für den Einbau als auch für den Aufbau geeignet ist. Mit ihrer getrennt schaltbaren Haupt- und Effektbeleuchtung bietet sie eine vielseitige Lichtgestaltung für jeden Raum.

The TAURUS spotlight series is characterised by its installation flexibility, as it is suitable for both recessed and surface-mounted installation. With its separately switchable main and effect lighting, it offers versatile lighting design for any room.



Metall · metal



**31** | Weiß matt · white mat



**32** | Schwarz matt · black mat

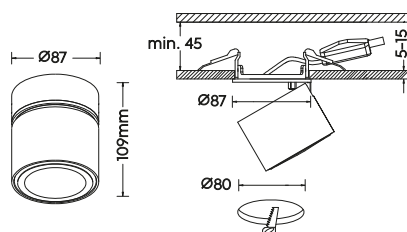

Strahler · Spot  
incl. SMD-LED  
5 W / 450 Lumen  
3.000 Kelvin  
1,5 W / 110 Lumen  
3.000 Kelvin  
**652910131**  
**652910132**

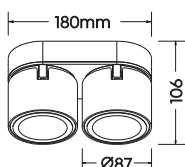

Strahler · Spot  
incl. SMD-LED  
2 x 5 W / 2 x 450 Lumen  
3.000 Kelvin  
2 x 1,5 W / 2 x 110 Lumen  
3.000 Kelvin  
**652910231**  
**652910232**

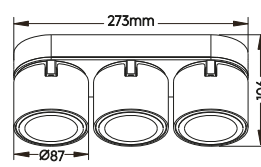
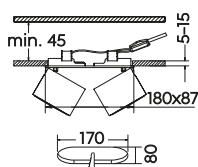

Strahler · Spot  
incl. SMD-LED  
3 x 5 W / 3 x 450 Lumen  
3.000 Kelvin  
3 x 1,5 W / 3 x 110 Lumen  
3.000 Kelvin  
**652910331**  
**652910332**

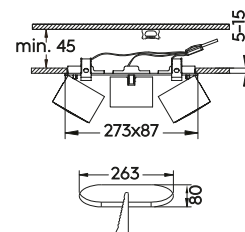







# GUAYANA

Diese Spots sind sowohl für den Einbau als auch für den Aufbau geeignet und bieten somit maximale Flexibilität bei der Installation. Mit ihrem modernen Design und der hochwertigen Verarbeitung fügen sie sich nahtlos in jede Raumgestaltung ein.

These spotlights are suitable for both recessed and surface-mounted installation and therefore offer maximum installation flexibility. With their modern design and high-quality finish, they blend seamlessly into any interior design.



Metall · metal

-  **07** | Nickel matt · nickel mat
-  **31** | Weiß matt · white mat
-  **32** | Schwarz matt · black mat

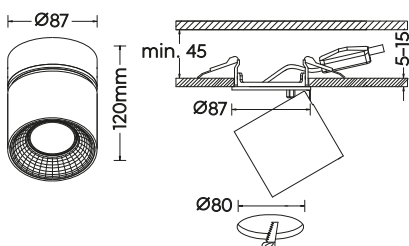

Strahler · Spot  
excl. 1 x GU10  
max. 10 W  
**651000107**  
**651000131**  
**651000132**

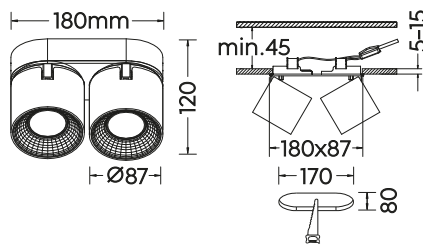

Strahler · Spot  
excl. 2 x GU10  
max. 10 W  
**651000207**  
**651000231**  
**651000232**

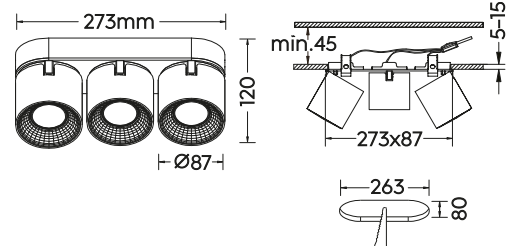

Strahler · Spot  
excl. 3 x GU10  
max. 10 W  
**651000307**  
**651000331**  
**651000332**





geeignet für Auf- und Einbau · suitable for both mounting and installation

# CLAPTON

Klassisches Design, modern interpretiert und stilvoll umgesetzt.

Klassisches Design, modern interpretiert und stilvoll umgesetzt.



Metall, Glas weiß gewischt · metal, white brushed glass

05 | Aluminium gebürstet · brushed Aluminium

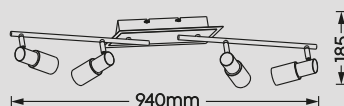
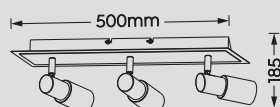
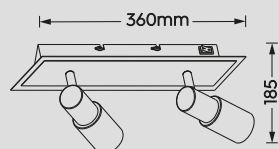

Strahler · Spot  
incl. OSRAM-LED  
2 x 4,3 W / 2 x 430 Lumen  
3.000 Kelvin  
821470205

Strahler · Spot  
incl. OSRAM-LED  
3 x 4,3 W / 3 x 430 Lumen  
3.000 Kelvin  
821410305

Strahler · Spot  
incl. OSRAM-LED  
4 x 4,3 W / 4 x 430 Lumen  
3.000 Kelvin  
821410405



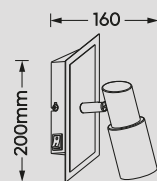

Strahler · Spot  
 incl. OSRAM-LED  
 1 x 4,3 W / 1 x 430 Lumen  
 3.000 Kelvin  
**821470105**

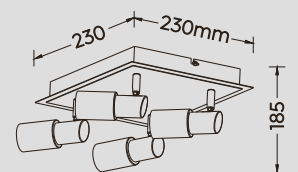

Strahler · Spot  
 incl. OSRAM-LED  
 4 x 4,3 W / 4 x 430 Lumen  
 3.000 Kelvin  
**821430405**



# NARCOS

Das moderne und ausgefallene Design macht die Serie NARCOS zu einem Eyecatcher mit Raffinesse.

The modern and unusual design makes the NARCOS range an eye-catcher with sophistication.



Metall, Acryl · metal, acryl  
 31 | Weiß matt · white mat

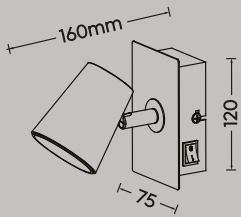
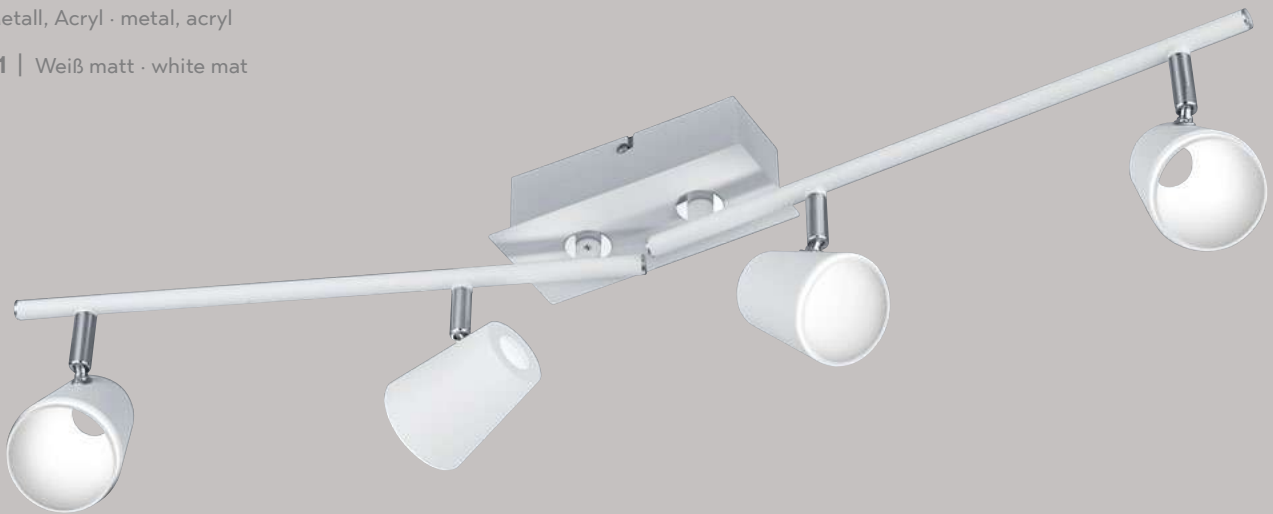

Strahler · Spot  
 incl. SMD-LED  
 6,5 W / 600 Lumen  
 3.000 Kelvin  
**873170131**

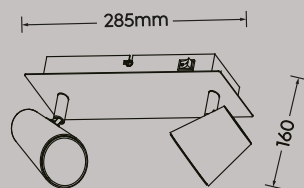

Strahler · Spot  
 incl. SMD-LED  
 2 x 6,5 W / 2 x 600 Lumen  
 3.000 Kelvin  
**873170231**

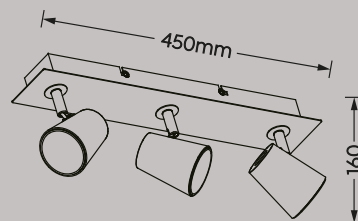

Strahler · Spot  
 incl. SMD-LED  
 3 x 6,5 W / 3 x 600 Lumen  
 3.000 Kelvin  
**873110331**



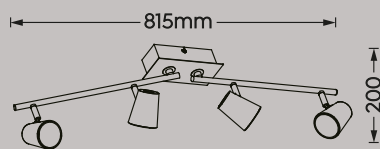

Strahler · Spot  
incl. SMD-LED  
4 x 6,5 W / 4 x 600 Lumen  
3.000 Kelvin  
873110431

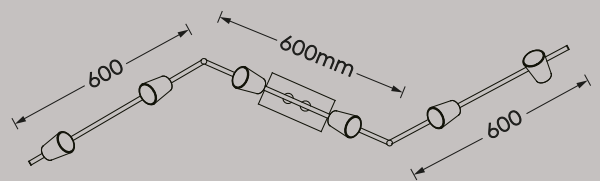

Strahler · Spot  
incl. SMD-LED  
6 x 6,5 W / 4 x 600 Lumen  
3.000 Kelvin  
873110631



# SHARP NEW

Die Spotserie SHARP bietet eine elegante Lösung für moderne Beleuchtungskonzepte. Mit ihrer klassischen Farbgebung in Schwarz oder Weiß fügt sie sich nahtlos in jedes Interieur ein. Besonders hervorzuheben ist die austauschbare Innenblende, die eine individuelle Anpassung an den jeweiligen Raum und Stil ermöglicht.

The SHARP spotlight series offers an elegant solution for modern lighting concepts. With its classic colour scheme in black or white, it blends seamlessly into any interior. Particularly noteworthy is the interchangeable inner cover, which enables customisation to the respective room and style.



Metall · metal

31 | Weiß matt · white mat

32 | Schwarz matt · black mat

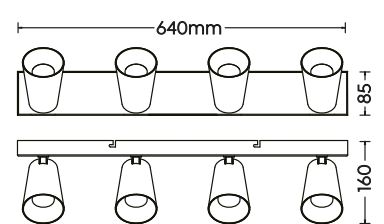
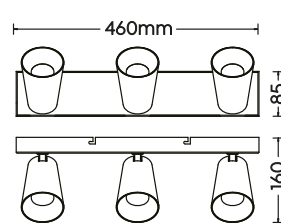
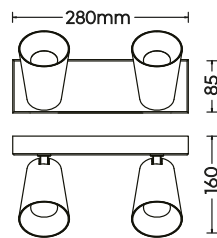
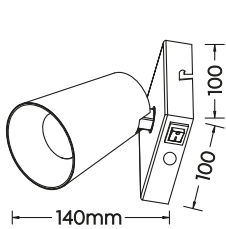

Strahler · Spot  
excl. 1 x GU10  
max. 10 W  
817170131  
817170132

Strahler · Spot  
excl. 2 x GU10  
max. 10 W  
817100231  
817100232

Strahler · Spot  
excl. 3 x GU10  
max. 10 W  
817100331  
817100332

Strahler · Spot  
excl. 4 x GU10  
max. 10 W  
817100431  
817100432







Die austauschbaren Innenblenden sind im Lieferumfang enthalten, was eine individuelle und flexible Gestaltung ermöglicht.

The interchangeable inner rings are included, which enables individual and flexible design.

# MARLEY NEW

Der warme Grauton harmonieren perfekt mit den kaffee-farbenen Akzenten und schaffen eine einladende und moderne Atmosphäre.

The warm grey tone harmonises perfectly with the coffee-coloured accents and creates an inviting and modern atmosphere.

Metall · metal

 **65** | Coffee/Warm Grau · coffee/warm grey

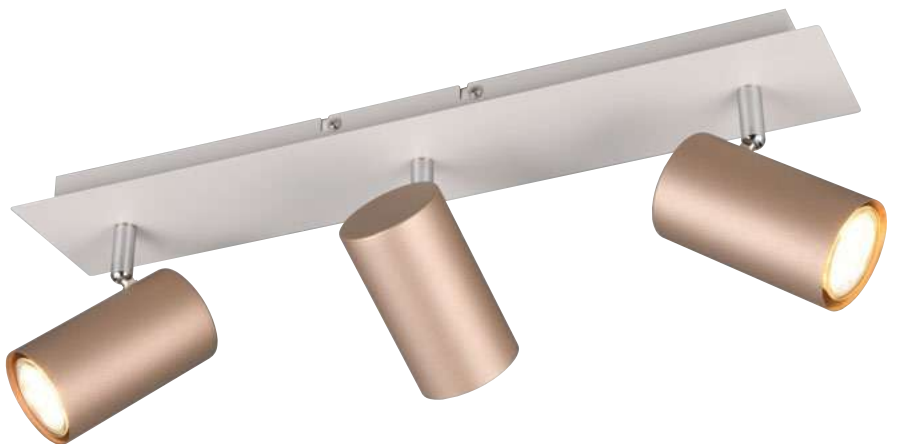
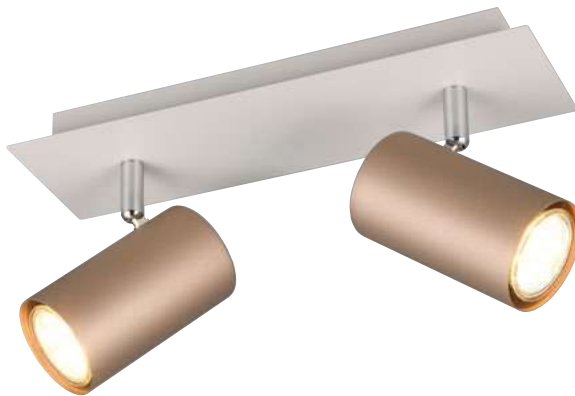

Empfohlen:  
recommended:

LED GU10  
4,5 W / 345 Lumen  
3.000 Kelvin

**956-5736**

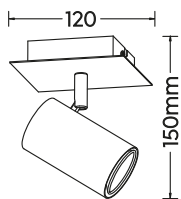

Strahler · Spot  
excl. 1 x GU10  
max. 25 W  
**802400165**

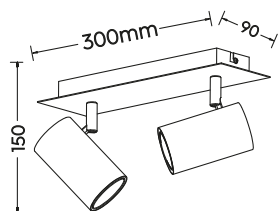

Strahler · Spot  
excl. 2 x GU10  
max. 35 W  
**802400265**

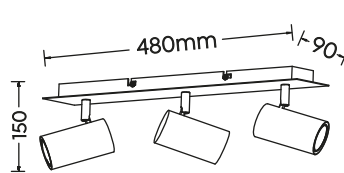

Strahler · Spot  
excl. 3 x GU10  
max. 35 W  
**802400365**



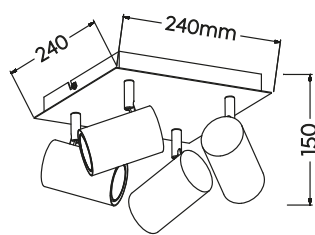

Strahler · Spot  
 excl. 4 x GU10  
 max. 35 W  
 802430465

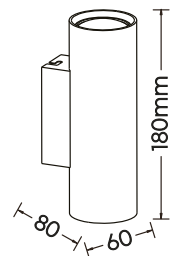

Wandleuchte · Wall lamp  
 excl. 2 x GU10  
 max. 35 W  
 212400265



# MARLEY

Diese Spotserie überzeugt durch ihr schlichtes Design und ihre vielseitige Einsetzbarkeit. Mit zahlreichen Optionen in Bezug auf Farben und Oberflächen bietet sie die perfekte Lösung für jede Raumgestaltung.

This spotlight series impresses with its simple design and versatility. With numerous options in terms of colours and surfaces, it offers the perfect solution for any room design.



Metall · metal

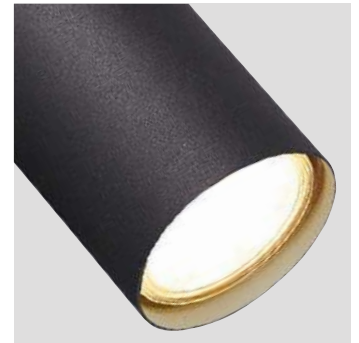
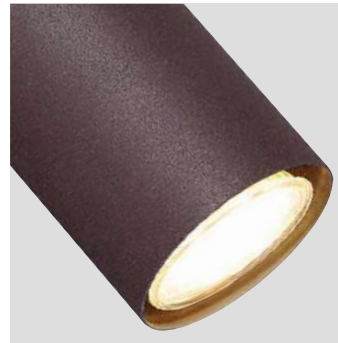
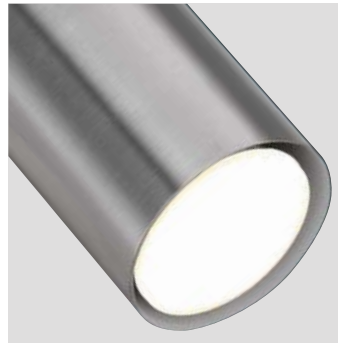

01 | Weiß · white

07 | Nickel matt · nickel mat

24 | rostfarbig · rusty

32 | Schwarz matt · black mat

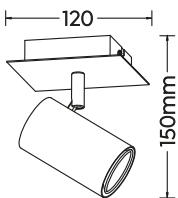

Strahler · Spot  
excl. 1 x GU10  
max. 25 W  
802400101  
802400107  
802400124  
802400132

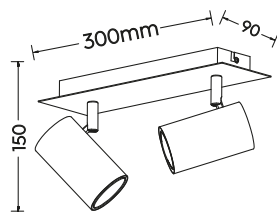

Strahler · Spot  
excl. 2 x GU10  
max. 35 W  
802400201  
802400207  
802400224  
802400232

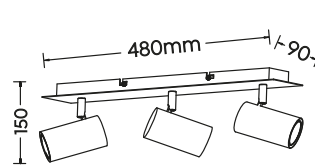

Strahler · Spot  
excl. 3 x GU10  
max. 35 W  
802400301  
802400307  
802400324  
802400332

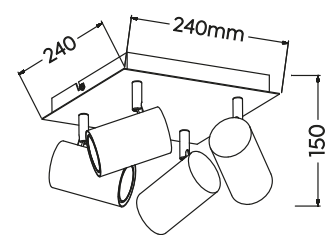

Strahler · Spot  
excl. 4 x GU10  
max. 35 W  
802430401  
802430407  
802430432



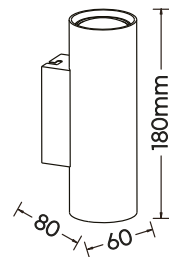
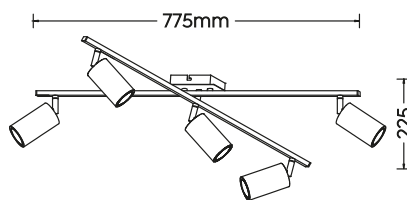

Empfohlen:  
recommended:

LED GU10  
4,5 W / 345 Lumen  
3.000 Kelvin  
**956-5736**



Deckenleuchte · Ceiling lamp

excl. 5 x GU10  
max. 35 W

**612400501**  
**612400507**  
**612400532**



IP20

Wandleuchte · Wall lamp

excl. 2 x GU10  
max. 35 W

**212400201**  
**212400207**  
**212400224**  
**212400232**



IP20

# MARLEY



Empfohlen:  
recommended:

LED GU10  
4,5 W / 345 Lumen  
3.000 Kelvin  
**956-5736**



Metall · metal



**04** | Altmessing · old brass



**80** | Schwarz-Gold · black-gold

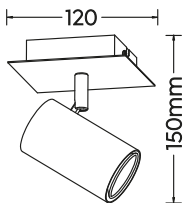

Strahler · Spot  
excl. 1 x GU10  
max. 25 W  
**802400104**  
**802400180**

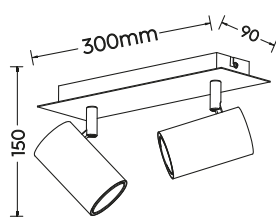

Strahler · Spot  
excl. 2 x GU10  
max. 35 W  
**802400204**  
**802400280**

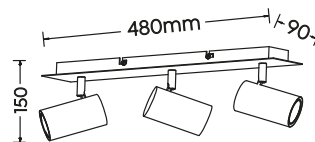

Strahler · Spot  
excl. 3 x GU10  
max. 35 W  
**802400304**  
**802400380**

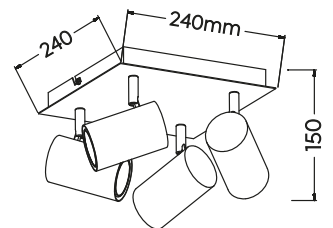

Strahler · Spot  
excl. 4 x GU10  
max. 35 W  
**802430404**  
**802430480**



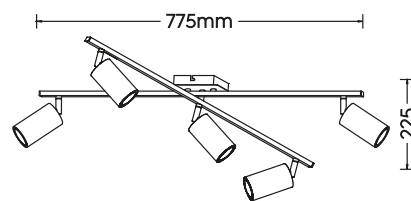

Deckenleuchte · Ceiling lamp  
 excl. 5 x GU10  
 max. 35 W  
**612400504**  
**612400580**

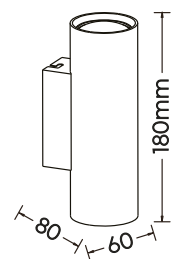

Wandleuchte · Wall lamp  
 excl. 2 x GU10  
 max. 35 W  
**212400204**



# MARLEY

Die Kombination aus Holz und modernen Materialien sorgt für eine besondere Note und macht diese Spotserie zu einem echten Highlight in jedem Raum.

The combination of wood and modern materials adds a special touch and makes this spotlight series a real highlight in any room.



Metall, Holz · metal, wood

07 | Nickel matt · nickel mat

31 | Weiß matt · white mat

32 | Schwarz matt · black mat

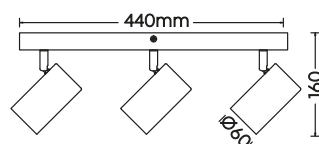
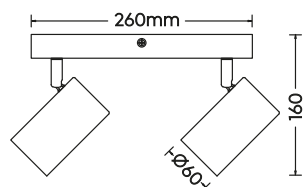
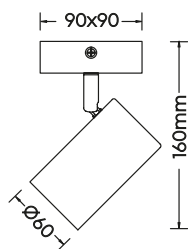

Strahler · Spot

excl. 1 x GU10  
max. 15 W

812400107

812400131

812400132

Strahler · Spot

excl. 2 x GU10  
max. 35 W

812400207

812400231

812400232

Strahler · Spot

excl. 3 x GU10  
max. 35 W

812400307

812400331

812400332







Empfohlen:  
recommended:

LED GU10  
4,5 W / 345 Lumen  
3.000 Kelvin  
**956-5736**

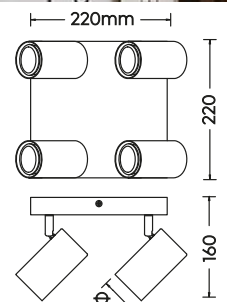

Strahler · Spot  
excl. 4 x GU10  
max. 35 W  
**812400407**  
**812400431**  
**812400432**



# PAGO

Die Spotserie PAGO zeichnet sich durch ihr schnörkelloses Design und ihre vielseitige Einsetzbarkeit aus. Diese Eigenschaften machen sie zu einer idealen Wahl für eine Vielzahl von Beleuchtungsszenarien.

The PAGO spotlight series is characterised by its sleek design and versatility. These characteristics make it an ideal choice for a variety of lighting scenarios.



Metall · metal

● 32 | Schwarz matt · black mat

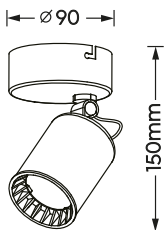
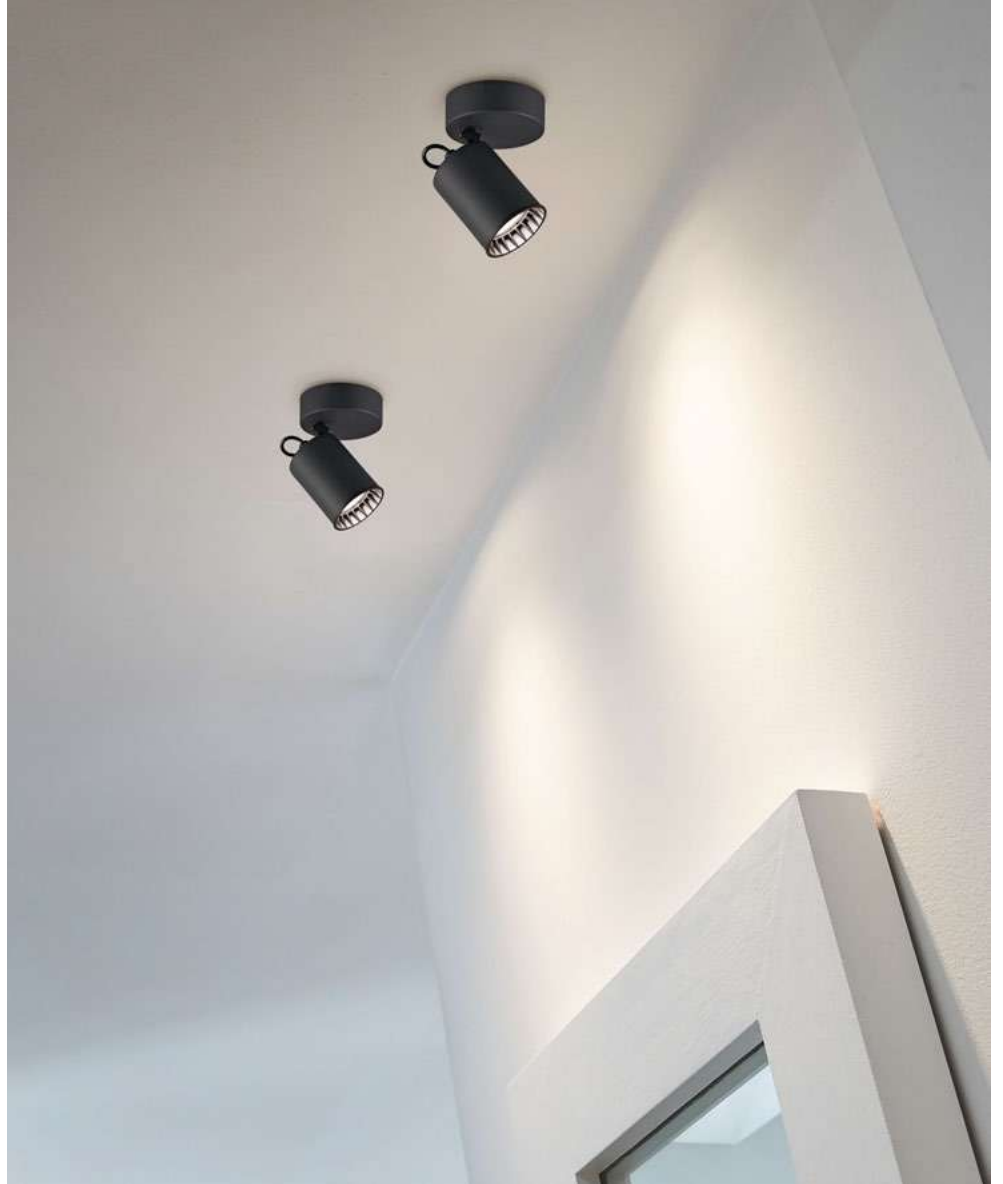

Strahler · Spot  
excl. 1 x GU10  
max. 35 W  
803500132

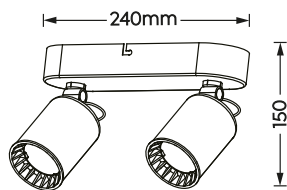

Strahler · Spot  
excl. 2 x GU10  
max. 35 W  
803500232

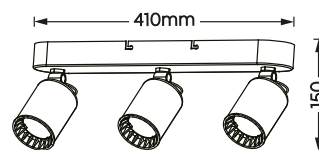

Strahler · Spot  
excl. 3 x GU10  
max. 35 W  
803500332



Empfohlen:  
recommended:

LED GU10  
4,9 W / 430 Lumen  
3.000 Kelvin  
**955-50**

# ARUNI

Diese Spotserie kombiniert stilvoll Holz mit Elementen in Schwarz oder Weiß und schafft so eine harmonische Verbindung von Natur und Moderne.

This spotlight series stylishly combines wood with elements in black or white, creating a harmonious combination of nature and modernity.



Metall, Holz naturbelassen · metal, wood natural finish

- 31** | Weiß matt · white mat
- 32** | Schwarz matt · black mat



Empfohlen:  
recommended:

LED GU10  
4,5 W / 345 Lumen  
3.000 Kelvin  
**956-5936**

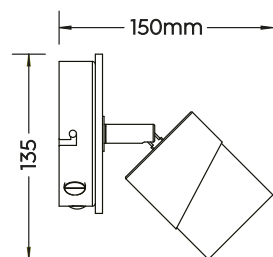

Strahler · Spot  
excl. 1 x GU10  
max. 10 W  
**801170131**  
**801170132**

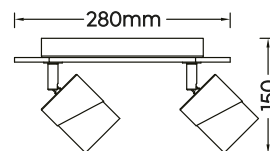

Strahler · Spot  
excl. 2 x GU10  
max. 10 W  
**801100231**  
**801100232**

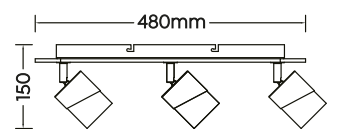

Strahler · Spot  
excl. 3 x GU10  
max. 10 W  
**801100331**  
**801100332**



# SHANTI NEW

Die Kombination aus warmgrauem Metallschirm und Holz ist ein beliebter Trend in der modernen Innenbeleuchtung. Diese Art von Leuchten bietet eine harmonische Balance zwischen industrieller Härte und natürlicher Wärme.

The combination of a warm grey metal shade and wood is a popular trend in modern interior lighting. This type of luminaire offers a harmonious balance between industrial rigour and natural warmth.



Metall, Holz · metal, wood

76 | Warm Grau · warm grey

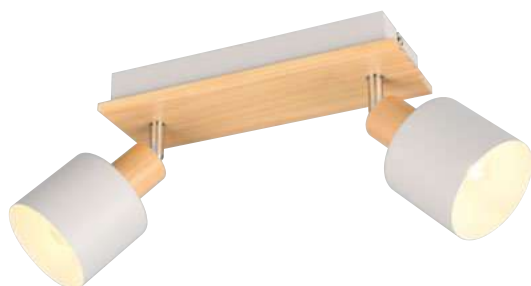

Empfohlen:  
recommended:

LED E14  
3,5 W / 320 Lumen  
3.000 Kelvin  
**983-40**

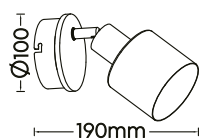

Strahler · Spot  
excl. 1 x E14  
max. 10 W  
**862700176**

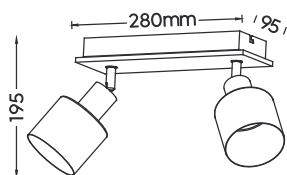

Strahler · Spot  
excl. 2 x E14  
max. 10 W  
**862700276**

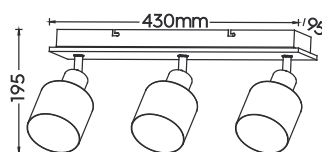

Strahler · Spot  
excl. 3 x E14  
max. 10 W  
**862700376**

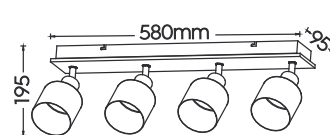

Strahler · Spot  
excl. 4 x E14  
max. 10 W  
**862700476**





# AROSA NEW



Die warmen Grautöne des Schirms sorgen für eine dezente Eleganz, während die gleichmäßige Lichtverteilung ein angenehmes und gemütliches Ambiente erzeugt.

The warm grey tones of the shade create a subtle elegance, while the uniform light distribution creates a pleasant and cosy ambience.

Metall, Stoffschirm Grau · metal, fabric shade grey



06 | Chrome · chrome

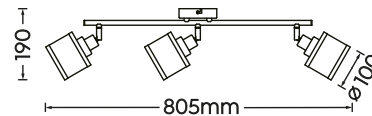
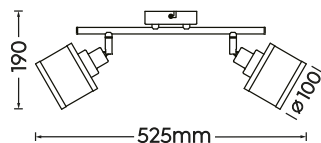
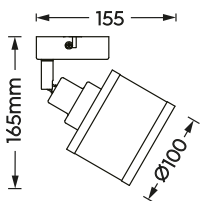

Strahler · Spot  
excl. 1 x E14  
max. 28 W  
**812100106**



Strahler · Spot  
excl. 2 x E14  
max. 28 W  
**812100206**



Strahler · Spot  
excl. 3 x E14  
max. 28 W  
**812100306**



Empfohlen:  
recommended:

Filament LED E14  
4 W / 470 Lumen  
2.700 Kelvin  
**983-400**

Metall holzfarbig, Stoff ·  
metal wood colored, fabric



**32** | Schwarz matt · black mat

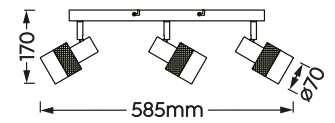
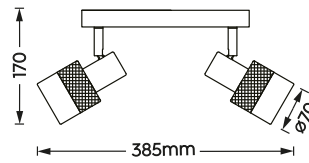
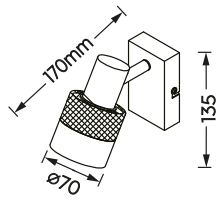

Empfohlen:  
recommended:

Filament LED E14  
4 W / 470 Lumen  
2.700 Kelvin  
**983-400**

Strahler · Spot  
excl. 1 x E14  
max. 10 W  
**811700132**



Strahler · Spot  
excl. 2 x E14  
max. 10 W  
**811700232**



Strahler · Spot  
excl. 3 x E14  
max. 10 W  
**811700332**



# LEVISTO

Die Serie LEVISTO in klassischem Design ist vielseitig einsetzbar. Diese Leuchten fügen sich harmonisch in jede Umgebung ein und sorgen für eine angenehme Beleuchtung.

The LEVISTO series with its classic design is versatile. These lights blend harmoniously into any environment and provide pleasant lighting.

Metall, Glas alabasterfarbig ·  
metal, alabaster-coloured glass

 **07** | Nickel matt · nickel mat

 **08** | Messing matt · brass mat

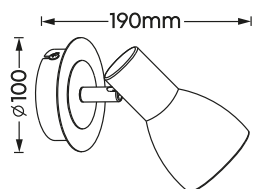

Strahler · Spot  
incl. 1 x LED E14  
5 W / 470 Lumen  
3.000 Kelvin  
**871010107**  
**871010108**

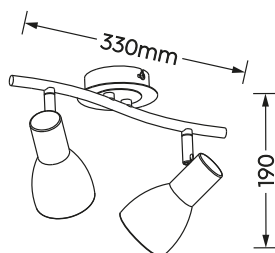

Strahler · Spot  
incl. 2 x LED E14  
2 x 5 W / 2 x 470 Lumen  
3.000 Kelvin  
**871010207**  
**871010208**

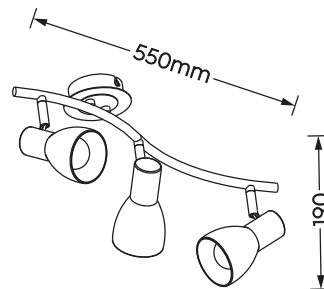

Strahler · Spot  
incl. 3 x LED E14  
3 x 5 W / 3 x 470 Lumen  
3.000 Kelvin  
**871010307**  
**871010308**





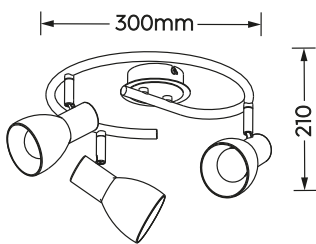

Strahler · Spot  
 incl. 3 x LED E14  
 3 x 5 W / 3 x 470 Lumen  
 3.000 Kelvin  
**871090307**  
**871090308**

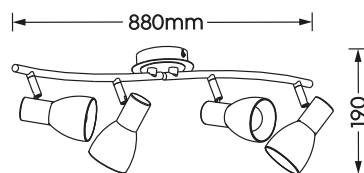

Strahler · Spot  
 incl. 4 x LED E14  
 4 x 5 W / 4 x 470 Lumen  
 3.000 Kelvin  
**871010407**  
**871010408**

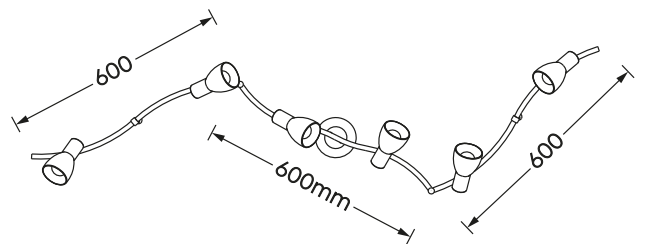

Strahler · Spot  
 incl. 6 x LED E14  
 6 x 5 W / 6 x 470 Lumen  
 3.000 Kelvin  
**871010607**  
**871010608**







# SCHIENEN- SYSTEM

## TRACK SYSTEM

Das DUOLine 2-Phasen-Strahlersystem ist eine vielseitige und anpassungsfähige Beleuchtungslösung, die sich ideal für verschiedene Wohn- und Arbeitsbereiche eignet. Es besteht aus mehreren Lichtquellen, die auf einer Schiene montiert sind und individuell ausgerichtet werden können.

The DUOLine 2-phase spotlight system is a versatile and adaptable lighting solution that is ideal for various living and working areas. It consists of several light sources that are mounted on a track and can be individually aligned.



### Für jede Raumsituation die ideale Beleuchtung.

Das DUOline 2-Phasen-Schiensystem ist äußerst flexibel und bietet zahlreiche Möglichkeiten zur individuellen Lichtgestaltung. Die verschiedenen Spots und Pendelleuchten lassen sich frei in der Schiene platzieren und können so gezielt in allen Wohnbereichen eingesetzt werden. Das 2-Phasensystem ermöglicht, dass mit nur einem Stromanschluss zwei Beleuchtungsgruppen getrennt voneinander geschaltet oder gedimmt werden können.

### The ideal lighting for every room situation.

The DUOline 2-phase track system is extremely flexible and offers numerous possibilities for individual lighting arrangements. The various spotlights and pendant lamps can be positioned as desired in the track and can therefore be used in all living areas. The 2-phase system allows two lighting groups to be switched or dimmed independently of each other with just one power connection.

### L'éclairage parfait pour chaque type de pièces.

Le système de rails biphasés DUOline est extrêmement flexible et offre de nombreuses possibilités de conception individuelle de l'éclairage. Les différents projecteurs et luminaires suspendus peuvent être positionnés librement dans le rail et peuvent donc être utilisés de manière spécifique dans tous vos espaces d'habitation. Le système biphasé permet de commuter ou de faire varier l'intensité de deux groupes d'éclairage séparément l'un de l'autre avec un seul branchement électrique.

### Voor elke situatie de ideale verlichting.

Het DUOline-2-fase-spoorsysteem is uiterst flexibel en biedt talrijke mogelijkheden voor een individuele lichtvormgeving. De diverse spots en hanglampen kunnen willekeurig in het spoor geplaatst worden en kunnen zo doelgericht in alle woonruimtes gebruikt worden. Het 2-fase-systeem maakt mogelijk dat met slechts één stroomaansluiting twee verlichtingsgroepen apart van elkaar geschakeld of gedimd kunnen worden.

### La iluminación ideal para cada habitación.

El sistema de rieles en 2 fases DUOline es extraordinariamente flexible y ofrece numerosas posibilidades de diseño lumínico individuales. Los distintos puntos y lámparas de péndulo le permiten colocar los rieles libremente y por eso pueden utilizarse en toda la vivienda. El sistema de rieles en 2 fases permite que se activen o atenúen dos grupos de lámparas separados con un solo cable de corriente.

### L'illuminazione ideale per qualsiasi esigenza abitativa.

Il sistema a binario bifase DUOline è estremamente flessibile e offre numerose possibilità per la progettazione individuale dell'illuminazione. I vari faretti e lampade a sospensione possono essere posizionati liberamente nel binario e possono quindi essere utilizzati in modo specifico in tutti gli ambienti abitativi. Il sistema bifase consente di commutare o dimmerare due gruppi di illuminazione separatamente l'uno dall'altro con una sola connessione di alimentazione.

### Iluminatul ideal pentru fiecare încăpere.

Sistemul de piste cu 2 faze DUOline este deosebit de flexibil și oferă numeroase posibilități pentru structurarea individuală a luminii. Diferitele spot-uri și lustre pot fi amplasate liber pe pistă și pot fi astel utilizate țintit în toate zonele spațiilor de locuit. Sistemul cu 2 faze permite comutarea și reglarea intensității pentru două grupuri de corpuri de iluminat separate, folosind un singur racord electric.

### Ihanteellinen valaistus jokaiseen huoneen käyttötilanteeseen.

DUOline 2-vaihekiskojärjestelmä on erittäin joustava ja tarjoaa lukuisia vaihtoehtoja yksilölliseen valaistuksen suunnitteluun. Eri spotti- ja ripustettavat valaisimet voidaan sijoittaa mihin tahansa kiskoon, joten niitä voidaan käyttää kaikissa asuintiloissa. 2-vaihejärjestelmä mahdollistaa kahden valaistusryhmän kytkemisen tai himmentämisen erikseen yhdellä sähköliitännällä.

### Idealne oświetlenie do każdej sytuacji w pomieszczeniu.

Dwufazowy system prowadnic DUOline jest niezwykle elastyczny i oferuje wiele opcji indywidualnego projektowania oświetlenia. Różne skupienia i lampy wiszące można umieścić w dowolnym miejscu na szynie, dzięki czemu można je stosować we wszystkich pomieszczeniach mieszkalnych. System 2-fazowy umożliwia osobne przełączanie lub przyciemnianie dwóch grup oświetlenia za pomocą tylko jednego podłączenia zasilania.

# ÜBERSICHT KOMPONENTEN

Component overview · Aperçu des composants · Overzicht van componenten ·  
Vista general por componentes · Panoramica dei componenti ·  
Prezentare generală a componentelor · Komponentteihin yleiskuvaus ·  
Przegląd komponentów

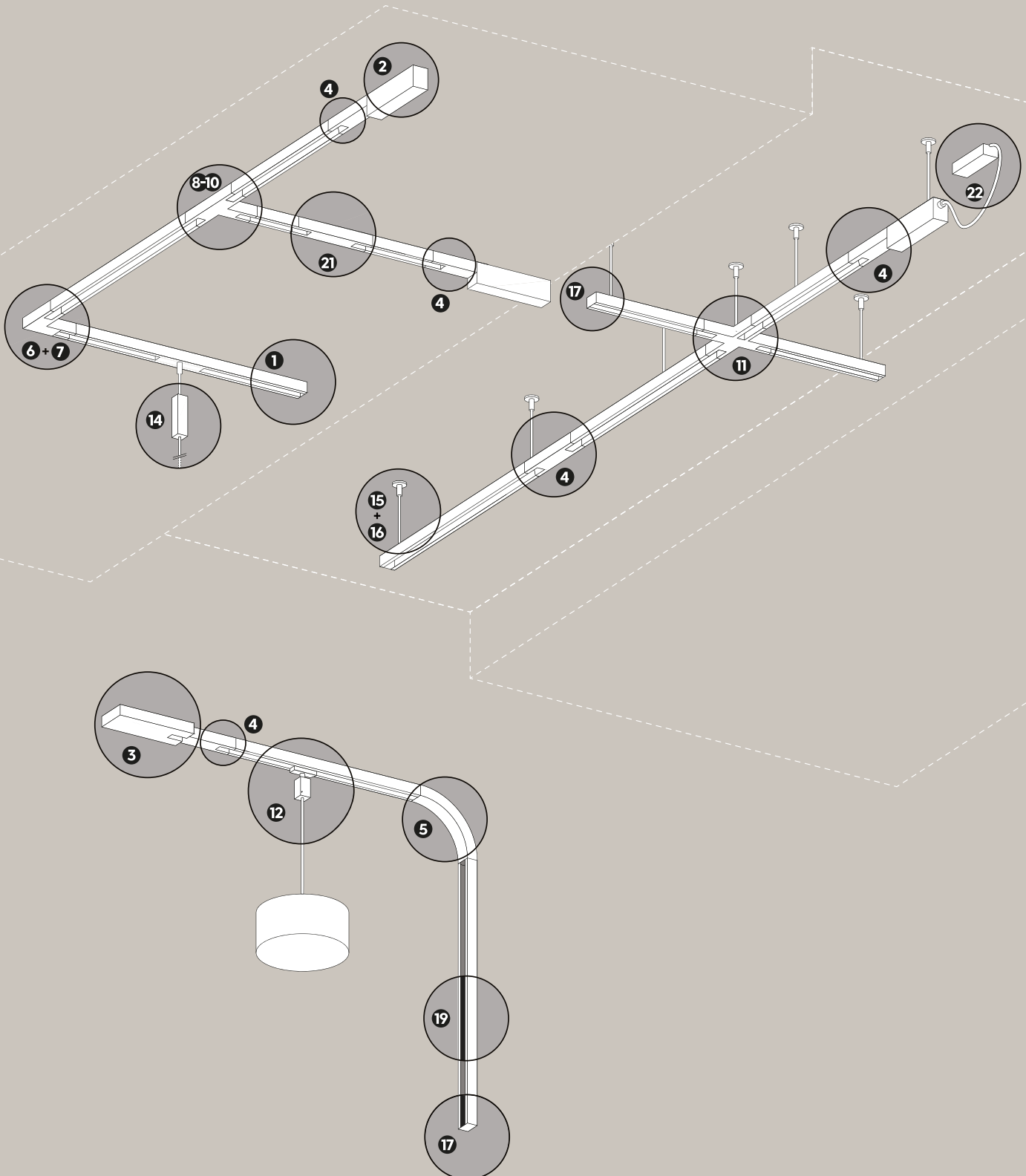

### Die Vorteile von DUOline im Überblick:

- Individuelle Lichtgestaltung
- Nur ein Stromanschluss erforderlich
- Kein Trafo notwendig
- Leuchten frei kombinierbar und leicht versetzbar
- Zwei verschiedene Lichtszenarien
- Getrenntes Schalten und Dimmen
- Für Decken- und Wandmontage geeignet

### Advantages of DUOline at a glance:

- individual lighting arrangements
- only one power connection required
- no need for a transformer
- lamps can be freely combined and are easily positioned
- two different lighting scenarios
- separate switching and dimming
- suitable for ceilings and walls

### Les avantages de DUOline en un coup d'œil :

- Conception individuelle de l'éclairage
- Une seule connexion électrique requise
- Pas besoin de transformateur
- Les luminaires peuvent être librement combinés et facilement déplacés
- Deux scénarios lumineux différents
- Commutation et variateur de lumière séparés
- Convient pour le montage au plafond et au mur

### Overzicht van de voordelen van DUOline:

- Individuele lichtvormgeving
- Slechts één stroomaansluiting nodig
- Geen transformator nodig
- Lampen willekeurig combineerbaar en gemakkelijk verplaatsbaar
- Twee verschillende lichtscenario's
- Apart schakelen en dimmen
- Geschikt voor plafond- en muurmontage

### Las ventajas de DUOline en resumen:

- Diseño lumínico individual
- Solo un cable de corriente necesario
- Ningún transformador necesario
- Lámpara combinables libremente y fácilmente desplazable
- Dos escenarios lumínicos diferentes
- Activación y atenuación separadas
- Adecuado para su montaje en techo y pared

### I vantaggi di DUOline in sintesi:

- Progettazione individuale dell'illuminazione
- È necessario un solo collegamento di alimentazione
- Non è necessario alcun trasformatore
- Le lampade possono essere liberamente combinate e facilmente spostate
- Due differenti scenari di illuminazione
- Commutazione e dimmerazione separate
- Adatto per il montaggio a soffitto e a parete

### Avantajele DUOline dintr-o privire:

- Structurarea individualizată a luminii
- Este necesară o singură conexiune electrică
- Nu este necesar un transformator
- Lămpile pot fi combinate liber și pot fi deplasate cu ușurință
- Două scenarii de iluminat diferite
- Comutare și reglare a intensității separate
- Adecvat pentru montajul pe plafon și pe perete

### DUOlinen edut lyhyesti:

- Yksilöllinen valaistussuunnittelu
- Vaaditaan vain yksi sähköliitäntä
- Muuntajaa ei tarvita
- Valaisimia voidaan yhdistellä vapaasti ja siirtää helposti
- Kaksi erilaista valaistusskenaariota
- Erillinen kytkentä ja himmennys
- Sopii katto- ja seinäasennukseen

### Zalety DUOline w skrócie:

- Indywidualny projekt oświetlenia
- Wymagane jest tylko jedno połączenie zasilania
- Nie wymaga transformatora
- Oprawy można dowolnie łączyć i łatwo przemieszczać
- Dwa różne scenariusze oświetlenia
- Oddzielne włączanie i ściemnianie
- Nadaje się do montażu sufitowego i ściennego

# SCHIENE · TRACK

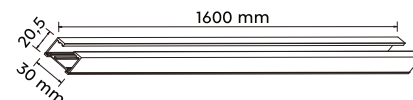
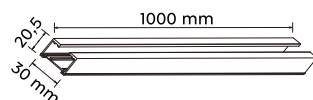
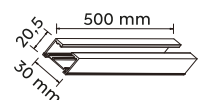

## 1 SCHIENE 50 CM · TRACKING 50 CM

Metall · metal



- 700131 | Weiß matt · white mat
- 700132 | Schwarz matt · black mat
- 700187 | titanfarbig · titan

## SCHIENE 100 CM · TRACKING 100 CM

Metall · metal



- 700231 | Weiß matt · white mat
- 700232 | Schwarz matt · black mat
- 700287 | titanfarbig · titan

## SCHIENE 160 CM · TRACKING 160 CM

Metall · metal



- 700331 | Weiß matt · white mat
- 700332 | Schwarz matt · black mat
- 700387 | titanfarbig · titan

Die maximale Montagelänge beträgt 30 Meter pro Einspeisung, bei einer Gesamtleistung von max. 600 Watt pro Phase.  
The maximum installation length is 30 metres per power feed, with a total capacity of max. 600 watts per phase.







## EINSPEISUNG · POWER SUPPLY



31



32



87

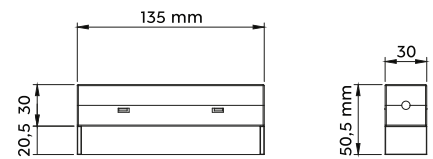

### 2 MITTEL-/END-EINSPEISUNG · MIDDLE-/ENDPOINT POWER SUPPLY

Kunststoff · plastic  
max. 2 x 600 W



701031 | Weiß matt · white mat  
701032 | Schwarz matt · black mat  
701087 | titanfarbig · titan

Die Mittel-/Endeinspeisung wird direkt über dem Stromauslass angebracht und ermöglicht, Schienen auf einer Seite oder auf beiden Seiten anzuschließen.  
Zur Stromversorgung der Schienen wird immer ein Verbinder benötigt.

The middle/end feed is mounted directly over the power outlet and enables tracks to be connected on one or both sides.  
A connector is always required to power the rails.



31



32

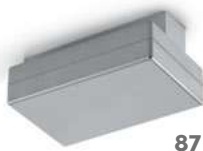

87

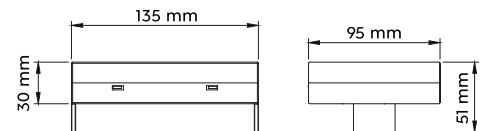

### 3 MITTEL-/END-EINSPEISUNG MIT ELEKTRONISCHEM PHASENWECHSLER · MIDDLE-/ENDPOINT POWER SUPPLY WITH ELECTRONIC PHASE CHANGER

Kunststoff · plastic  
max. 2 x 200 W



701131 | Weiß matt · white mat  
701132 | Schwarz matt · black mat  
701187 | titanfarbig · titan

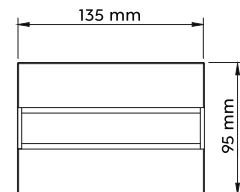

Mittels elektronischem Phasenwechsler lassen sich die zwei Phasen auch bei dreiadrigen Stromleitungen getrennt Schalten und Dimmen.  
Zur Stromversorgung der Schienen wird immer ein Verbinder benötigt.

Using an electronic phase changer, the two phases can be switched and dimmed separately, even with three-core power cables.  
A connector is always required to power the rails.

# VERBINDER · CONNECTOR



31



32



87

## 4 LÄNGSVERBINDER · LINE CONNECTOR

Kunststoff · plastic  
max. 2 x 600 W



702131 | Weiß matt · white mat  
702132 | Schwarz matt · black mat  
702187 | titanfarbig · titan

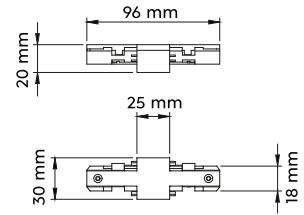

Verbindet zwei Schienen für gerade Strecken miteinander.  
Connects two rails together for straight sections.



31



32



87

## 5 FLEX-VERBINDER · FLEX CONNECTOR

Kunststoff · plastic  
max. 2 x 600 W



702031 | Weiß matt · white mat  
702032 | Schwarz matt · black mat  
702087 | titanfarbig · titan

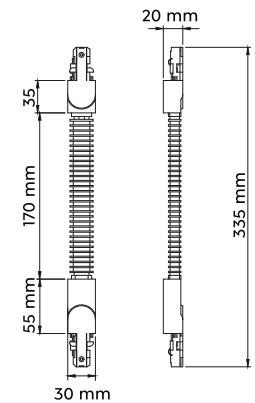

Verbindet zwei Schienen in einem beliebigen Winkel miteinander und ermöglicht die Verbindung zwischen Decken- und Wandmontage.  
Connects two rails together at any angle and makes possible a connection between ceiling and wall mounting.



31



32



87

## 6 L-VERBINDER - SCHUTZLEITER INNEN · L-CONNECTOR - INNER PROTECTIVE CONDUCTOR

Kunststoff · plastic  
max. 2 x 600 W



702231 | Weiß matt · white mat  
702232 | Schwarz matt · black mat  
702287 | titanfarbig · titan

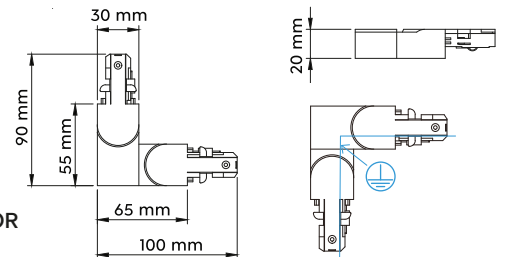

## 7 L-VERBINDER (TYP A) - SCHUTZLEITER AUSSEN · L-CONNECTOR (TYPE A) - OUTER PROTECTIVE CONDUCTOR

Kunststoff · plastic  
max. 2 x 600 W



702231A | Weiß matt · white mat  
702232A | Schwarz matt · black mat  
702287A | titanfarbig · titan

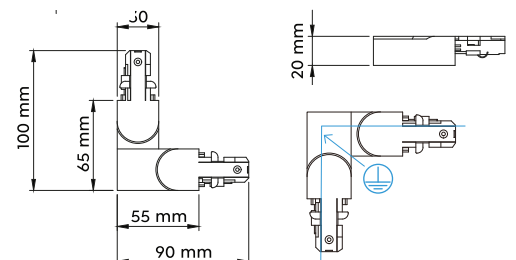

Verbindet zwei Schienen im rechten Winkel miteinander.  
Connects two rails together at right angles.



31



32



87

**8** T-VERBINDER - SCHUTZLEITER RECHTS ·  
T-CONNECTOR - RIGHT PROTECTIVE CONDUCTOR

Kunststoff · plastic  
max. 2 x 600 W



- 702331 | Weiß matt · white mat
- 702332 | Schwarz matt · black mat
- 702387 | titanfarbig · titan

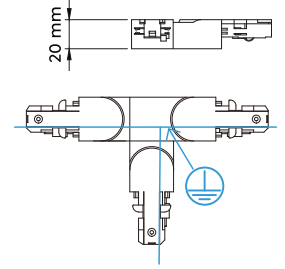
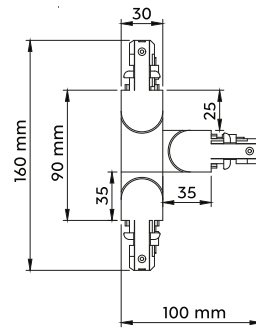

31



32



87

**9** T-VERBINDER (TYP A) - SCHUTZLEITER LINKS ·  
T-CONNECTOR (TYPE A) - LEFT PROTECTIVE CONDUCTOR

Kunststoff · plastic  
max. 2 x 600 W



- 702331A | Weiß matt · white mat
- 702332A | Schwarz matt · black mat
- 702387A | titanfarbig · titan

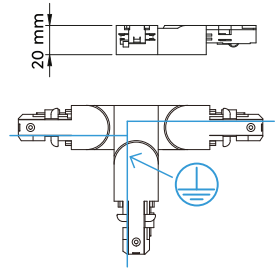
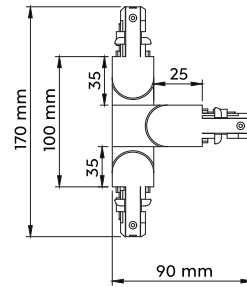

31



32



87

**10** T-VERBINDER (TYP B) - SCHUTZLEITER LINKS ·  
T-CONNECTOR (TYPE B) - LEFT PROTECTIVE CONDUCTOR

Kunststoff · plastic  
max. 2 x 600 W



- 702331B | Weiß matt · white mat
- 702332B | Schwarz matt · black mat
- 702387B | titanfarbig · titan

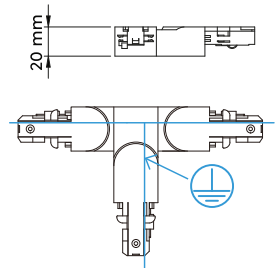
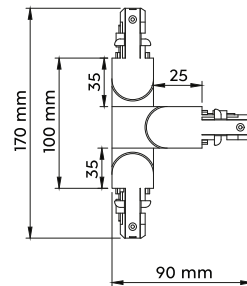

Verbindet drei Schienen im rechten Winkel miteinander.  
Connects three rails together at right angles.



31



32



87

**11** X-VERBINDER · X-CONNECTOR

Kunststoff · plastic  
max. 2 x 600 W



- 702431 | Weiß matt · white mat
- 702432 | Schwarz matt · black mat
- 702487 | titanfarbig · titan

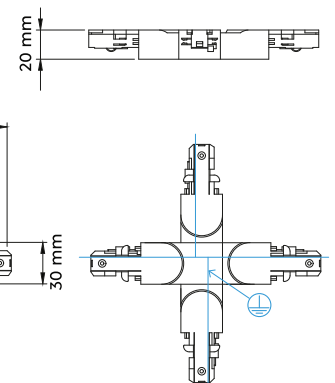
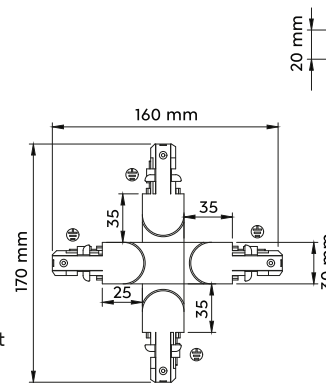

Verbindet vier Schienen im rechten Winkel miteinander.  
Connects four tracks together at right angles to each other.

Planungsbeispiel A · Planning example A

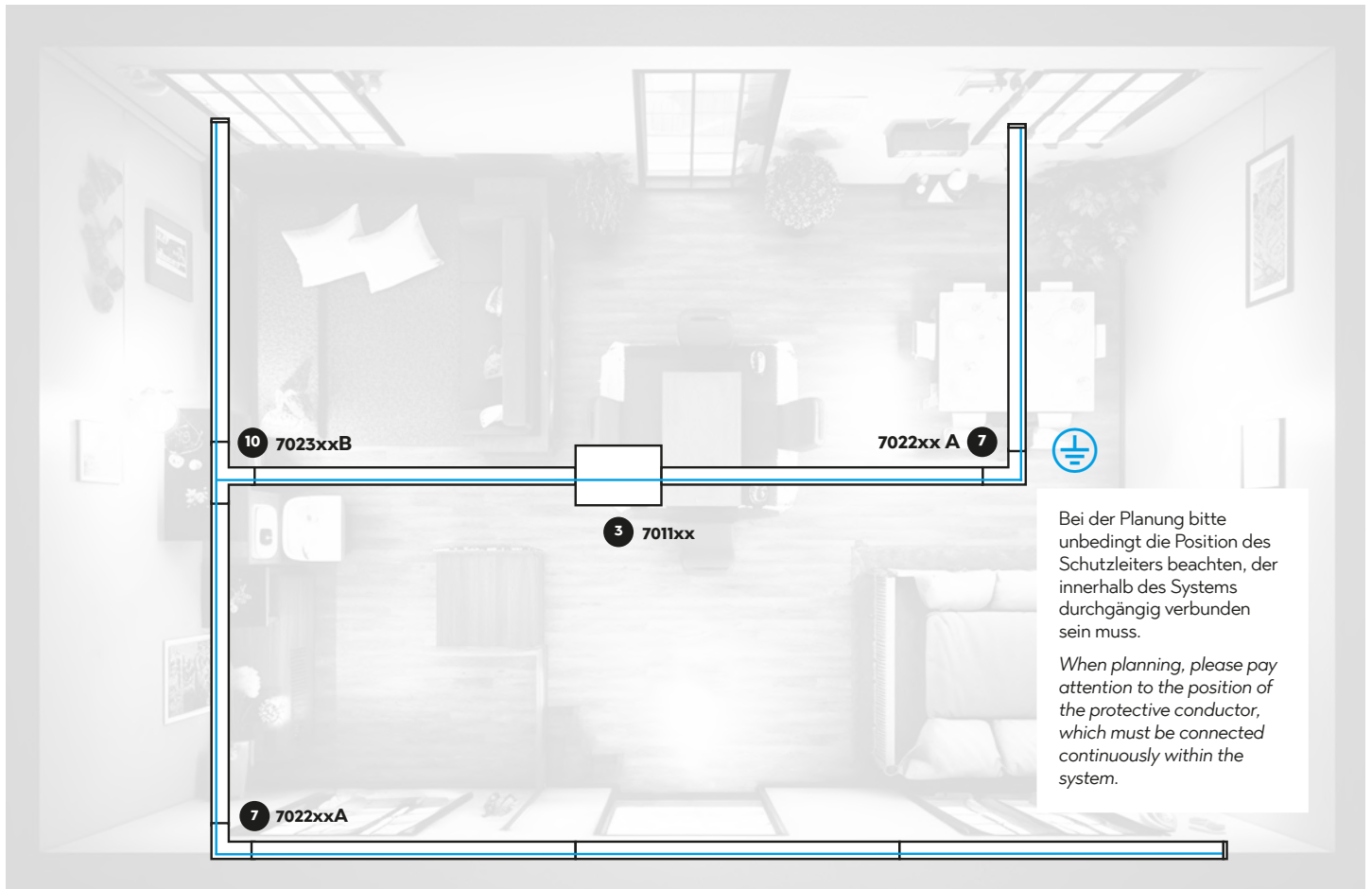

Planungsbeispiel B · Planning example B

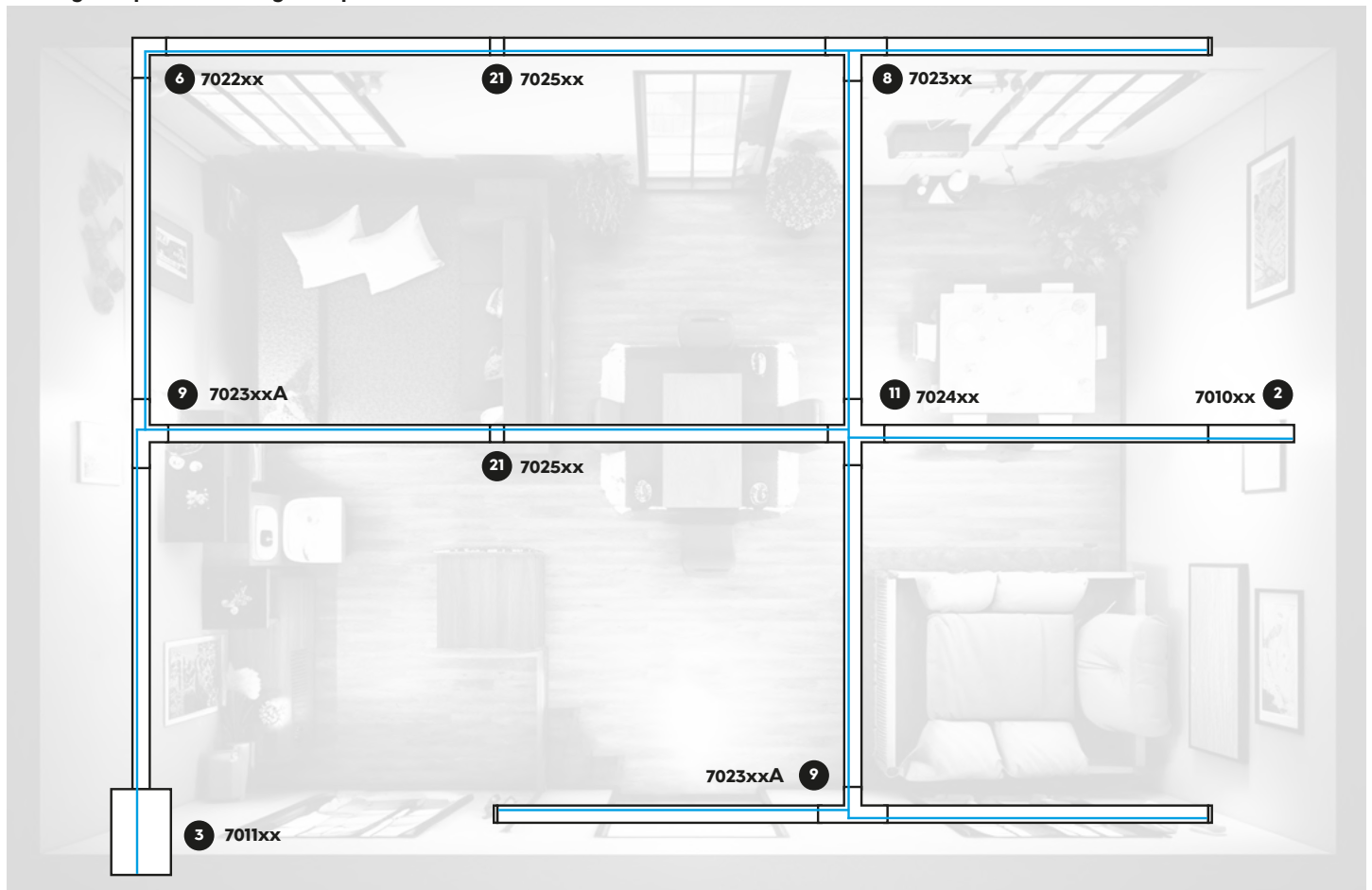

Die Komponenten sind so eingezeichnet, wie sie an der Decke/Wand montiert werden sollen.

**Ansicht der Komponenten von oben auf der Montageseite.**

The components are drawn in as they are to be mounted on the ceiling/wall.

**View of the components from above on the mounting side.**

Draufsicht · Top view

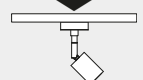

# ZUBEHÖR · ACCESSORIES

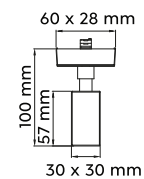

## 12 PENDEL-ADAPTER · PENDULAR ADAPTER

Kunststoff · plastic  
max. 60 W



703631 | Weiß matt · white mat  
703632 | Schwarz matt · black mat  
703687 | titanfarbig · titan

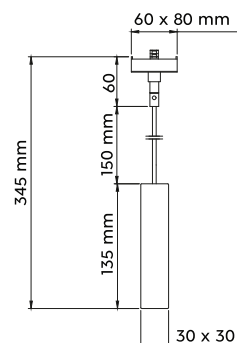
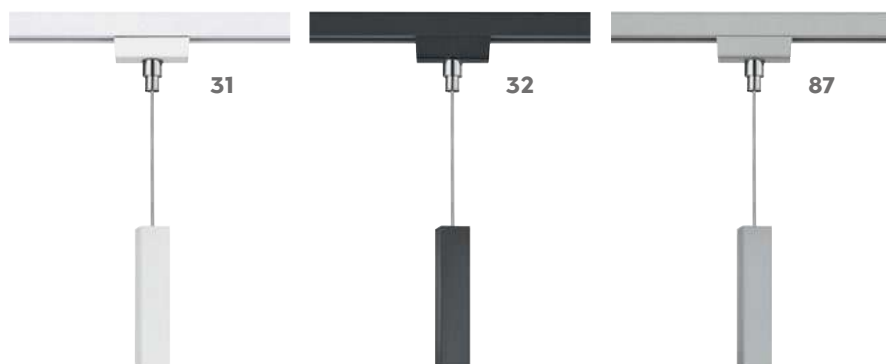

## 13 PENDEL-ADAPTER · PENDULAR ADAPTER

Kunststoff · plastic  
max. 60 W



703531 | Weiß matt · white mat  
703532 | Schwarz matt · black mat  
703587 | titanfarbig · titan

Dieser Pendel-Adapter ermöglicht es, herkömmliche Pendelleuchten in das DUOline Schienensystem zu integrieren.  
This pendular adapter makes it possible for conventional pendular lamps to be integrated into the DUOline track system.

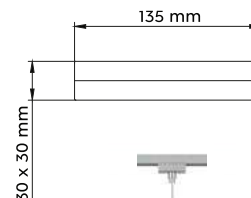

## 14 KABELKÜRZER · CABLE SHORTENER

Kunststoff · plastic

703331 | Weiß matt · white mat  
703332 | Schwarz matt · black mat  
703387 | titanfarbig · titan



Ermöglicht das Kürzen der Kabel von Pendelleuchten.  
Makes a shortening of the pendal lamp cable possible.



31



32



87

15 DISTANZHALTER SET · SUSPENSION SET

Metall · metal

- 703131 | Weiß matt · white mat
- 703132 | Schwarz matt · black mat
- 703187 | titanfarbig · titan

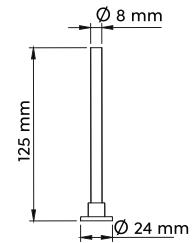

31



32



87

16 DISTANZHALTER SET · SUSPENSION SET

Metall · metal

- 703231 | Weiß matt · white mat
- 703232 | Schwarz matt · black mat
- 703287 | titanfarbig · titan

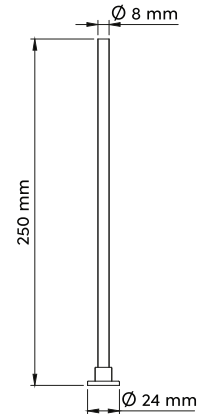

31



32



87

17 ENDKAPPEN · END CAPS

Kunststoff · plastic

- 703031 | Weiß matt · white mat
- 703032 | Schwarz matt · black mat
- 703087 | titanfarbig · titan

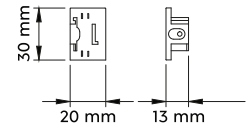

31



32



87

18 AUSTAUSCHCOVER FÜR ADAPTER · EXCHANGE COVER FOR ADAPTER

Kunststoff · plastic

- 703731 | Weiß matt · white mat
- 703732 | Schwarz matt · black mat
- 703787 | titanfarbig · titan

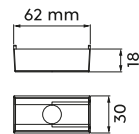

19 ABDECKSCHIENE · SAFETY COVER STRIP

Kunststoff · plastic  
↔ 100 x 1,4 cm, ↗ 0,5 cm

- 703952 | Transparent · transparent



20 ABDECKPLATTE · COVER PLATE

Metall · metal  
↑ 0,1 cm, Ø 1 cm

- 703431 | Weiß matt · white mat



31



32



87

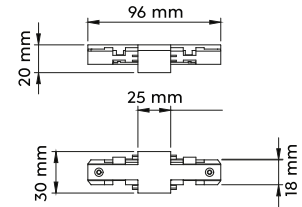

## 21 ISOLATOR · ISOLATOR

Kunststoff · plastic

702531 | Weiß matt · white mat

702532 | Schwarz matt · black mat

702587 | titanfarbig · titan

Mittels Isolator können zwei separate Schaltkreise optisch zu einem System verbunden werden.

Using an isolator, two separate circuits can be optically connected to form one system.



31



32



87

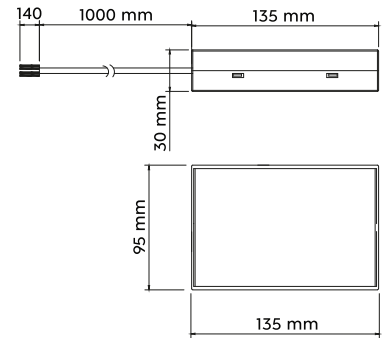

## 22 FLEXIBLE STROMVERSORGUNG · FLEX POWER SUPPLY

Kunststoff · plastic  
max. 2 x 600 W



701231 | Weiß matt · white mat

701232 | Schwarz matt · black mat

701287 | titanfarbig · titan

Die flexible Stromversorgung wird benötigt, wenn die Schienen nicht direkt über den Stromauslass verlegt werden können.

**Nur in Verbindung mit einer Mittel-/Endeinspeisung.**

The flexible power supply is required if the rails cannot be mounted directly over the power outlet.

**Only in use with a middle-/endpoint power supply.**

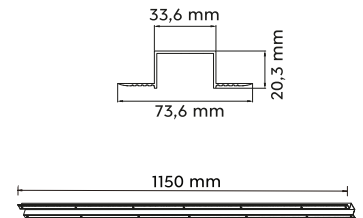

## 23 EINBAUPROFIL 115 CM · RECESSED PROFILE 115 CM

Aluminium · aluminium

703809 | aluminiumfarbig · aluminium

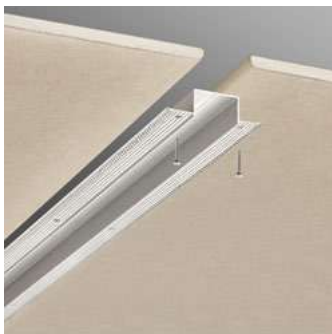

Mit diesem Einbauprofil als Zubehör können die Stromschienen anstelle der Aufputz-Montage bündig in der Decke montiert werden.

With this recessed profile as an accessory, the power tracks can be mounted flush in the ceiling instead of surface mounting.

# RADIATOR

Metall · metal



31



32



87

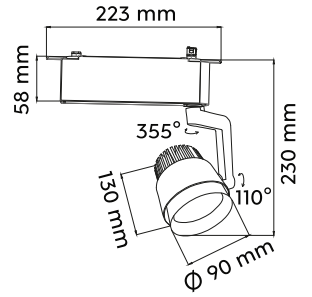

## STRAHLER · SPOT

incl. SMD-LED, 15 W

1.270 Lumen, 2.300 / 3.000 / 4.000 Kelvin



78030131 | Weiß matt · white mat

78030132 | Schwarz matt · black mat

78030187 | titanfarbig · titan



## DIP SWITCH

Mittels DIP-SWITCH können drei Lichtfarben (Warmweiß, Neutralweiß, Universalweiß) über einen Schalter direkt an der Leuchte eingestellt werden.

The DIP SWITCH directly sets the luminaire's three light colours (warm, neutral and universal white).

# LEON

Metall · metal



07



31



32

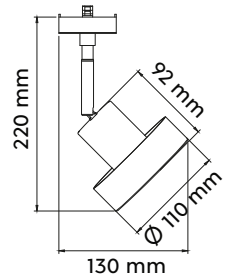

## STRAHLER · SPOT

excl. 1 x GU10, max. 25 W



78070107 | Nickel matt · nickel mat

78070131 | Weiß matt · white mat

78070132 | Schwarz matt · black mat



Empfohlen:  
recommended:

LED GU10  
4,5 W / 345 Lumen  
3.000 Kelvin  
**956-5936**







# ONTARIO

Glas Weiß · glass white

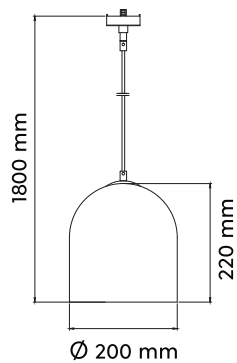

PENDELLEUCHTE · PENDANT  
excl. 1 x E14, max. 25 W



73520101 | Weiß · white

# ANTIBES

Metall, Glas Weiß · metal, glass white

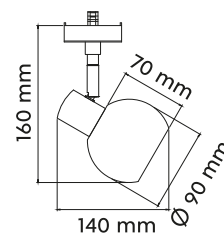

STRAHLER · SPOT  
excl. 1 x E14, max. 25 W



78170107 | Nickel matt · nickel mat

# LUMINA

Metall, Glas chrom bedampft · metal, chrome plated glass

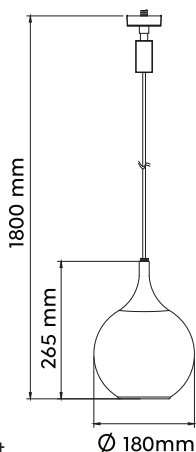

PENDELLEUCHTE · PENDANT  
excl. 1 x E14, max. 40 W



73700132 | Schwarz matt · black mat

# ROBIN

Metall, Glas rauchfarbig · metal, glass smoke

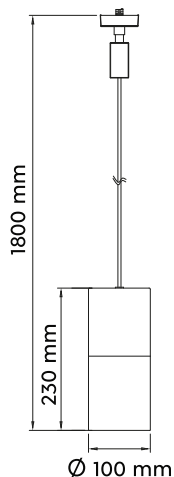

PENDELLEUCHTE · PENDANT  
excl. 1 x E27, max. 28 W



73060132 | Schwarz matt · black mat





# MARLEY

Metall · metal



32



07



31

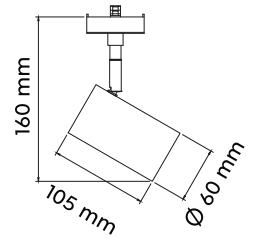

## STRAHLER · SPOT

excl. 1 x GU10, max. 25 W



IP20

78240107 | Nickel matt · nickel mat

78240131 | Weiß matt · white mat

78240132 | Schwarz matt · black mat



07



31



32

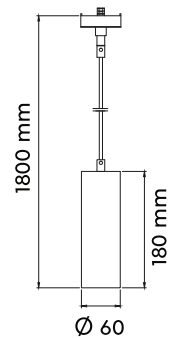

## PENDELLEUCHE · PENDANT

excl. 1 x GU10, max. 25 W



IP20

73240107 | Nickel matt · nickel mat

73240131 | Weiß matt · white mat

73240132 | Schwarz matt · black mat

# PANEL

Kunststoff · plastic

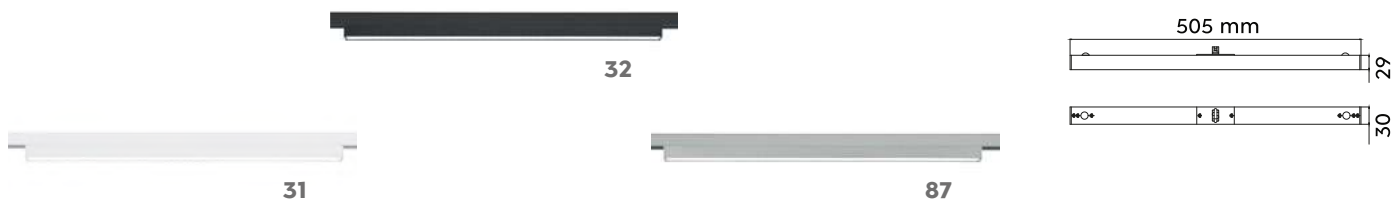

## LED-PANEL

incl. SMD-LED, 6 W  
850 Lumen, 3.000 Kelvin



- 77020131 | Weiß matt · white mat
- 77020132 | Schwarz matt · black mat
- 77020187 | titanfarbig · titan

# CAMILLUS

Kunststoff · plastic



## LED-PANEL

incl. SMD-LED, 9 W  
900 Lumen, 3.000 Kelvin



- 76921031 | Weiß matt · white mat
- 76921032 | Schwarz matt · black mat
- 76921087 | titanfarbig · titan





# PAROS

Metall · metal

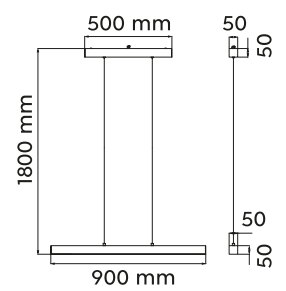
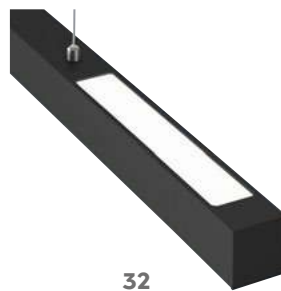

**PENDELLEUCHTE · PENDANT**  
incl. SMD-LED, 29 W  
3.400 Lumen, 3.000 Kelvin

- 73043107 | Nickel matt · nickel mat
- 73043131 | Weiß matt · white mat
- 73043132 | Schwarz matt · black mat



# TOMMY

Stoffschirm · fabric shade



01

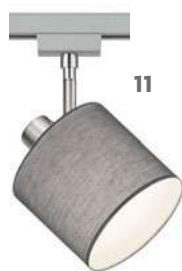

11



79

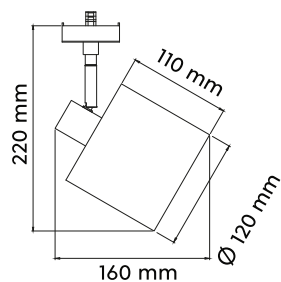

STRAHLER · SPOT  
excl. 1 x E14, max. 25 W



78330101 | Weiß · white  
78330111 | Grau · grey  
78330179 | goldfarbig · gold

# TOSH

Metall, Holz · metal, wood

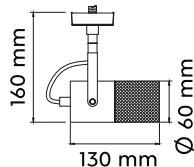

STRAHLER · SPOT  
excl. 1 x E14, max. 25 W



78430132 | Schwarz matt · black mat

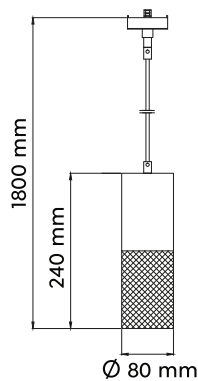

PENDELLEUCHE · PENDANT  
excl. 1 x E27, max. 25 W



73430132 | Schwarz matt · black mat





# JIMMY

Metall, innen goldfarbig · metal, gold colored inside



PENDELLEUCHE · PENDANT  
excl. 1 x E27, max. 25 W



73120102 | Schwarz · black

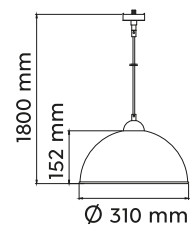







# EINBAU- LEUCHTEN

## RECESSED SPOTS

Einbauleuchten sind eine beliebte Wahl für moderne Innenräume, da sie eine unauffällige und dennoch effektive Beleuchtung bieten. Diese Leuchten werden direkt in Decken eingebaut und fügen sich nahtlos in das Raumdesign ein. Durch ihr minimalistisches Design passen Einbauleuchten zu nahezu jedem Einrichtungsstil.

Recessed luminaires are a popular choice for modern interiors as they provide unobtrusive yet effective lighting. These lights are installed directly into ceilings and blend seamlessly into the room design. Thanks to their minimalist design, recessed luminaires match almost any interior style.

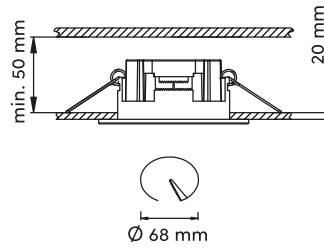

Getrennt schaltbar · Separately switchable



## CORE

Kunststoff · plastic

ART.-NR. / CODE	LM / BULB	LEISTUNG / POWER	LUMEN	KELVIN	BxHxD / WxHxD	FARBE / COLOUR
652510106	SMD-LED	5 W	450	3.000	Ø 82 x 35 mm	Chrom · chrome
652510131	SMD-LED	5 W	450	3.000	Ø 82 x 35 mm	Weiß matt · white mat
652510132	SMD-LED	5 W	450	3.000	Ø 82 x 35 mm	Schwarz matt · black mat

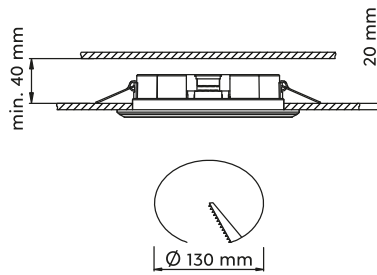

Getrennt schaltbar · Separately switchable

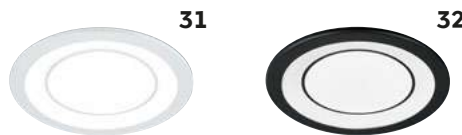

## CORE

Kunststoff · plastic

ART.-NR. / CODE	LM / BULB	LEISTUNG / POWER	LUMEN	KELVIN	BxHxD / WxHxD	FARBE / COLOUR
652610106	SMD-LED	10 W	1.040	3.000	Ø 148 x 33 mm	Chrom · chrome
652610131	SMD-LED	10 W	1.040	3.000	Ø 148 x 33 mm	Weiß matt · white mat
652610132	SMD-LED	10 W	1.040	3.000	Ø 148 x 33 mm	Schwarz matt · black mat

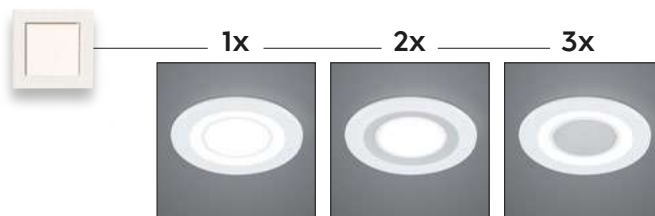

Getrennt schaltbar · Separately switchable





31

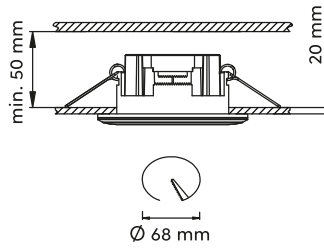

06



32



Getrennt schaltbar · Separately switchable

## AURA

Kunststoff · plastic

ART.-NR. / CODE	LM / BULB	LEISTUNG / POWER	LUMEN	KELVIN	BxHxT / WxHxD	FARBE / COLOUR
652310106	SMD-LED	5 W	450	3.000	Ø 82 x 40 mm	Chrom · chrome
652310131	SMD-LED	5 W	450	3.000	Ø 82 x 40 mm	Weiß matt · white mat
652310132	SMD-LED	5 W	450	3.000	Ø 82 x 40 mm	Schwarz matt · black mat



32

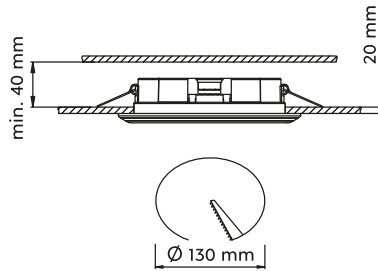

06



31



Getrennt schaltbar · Separately switchable

## AURA

Kunststoff · plastic

ART.-NR. / CODE	LM / BULB	LEISTUNG / POWER	LUMEN	KELVIN	BxHxT / WxHxD	FARBE / COLOUR
652410106	SMD-LED	10 W	1.040	3.000	Ø 148 x 38 mm	Chrom · chrome
652410131	SMD-LED	10 W	1.040	3.000	Ø 148 x 38 mm	Weiß matt · white mat
652410132	SMD-LED	10 W	1.040	3.000	Ø 148 x 38 mm	Schwarz matt · black mat

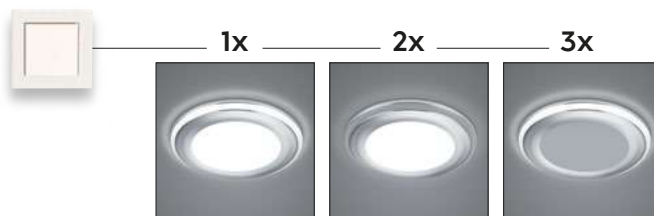

Getrennt schaltbar · Separately switchable





06

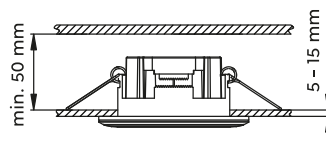

Ø 75 mm

31

32



Getrennt schaltbar · Separately switchable

## NIMBUS

Kunststoff · plastic

ART.-NR. / CODE	LM / BULB	LEISTUNG / POWER	LUMEN	KELVIN	BxHxD / WxHxD	FARBE / COLOUR
653410106	SMD-LED	5 W	450	3.000	85 x 85 x 40 mm	Chrom · chrome
653410131	SMD-LED	5 W	450	3.000	85 x 85 x 40 mm	Weiß matt · white mat
653410132	SMD-LED	5 W	450	3.000	85 x 85 x 40 mm	Schwarz matt · black mat



IP44

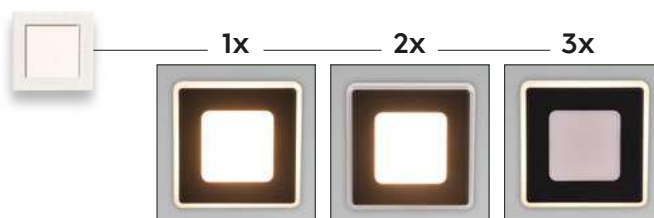

Getrennt schaltbar · Separately switchable



Getrennt schaltbar · Separately switchable

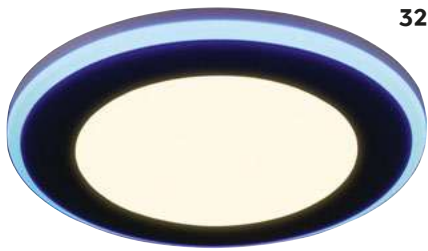

32

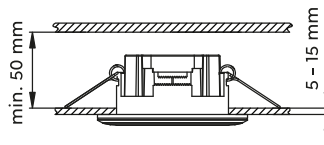

Ø 68 mm

06



31



RGB Farbwechsler · RGB Colorchanging



Memory Funktion · Memory function

Kunststoff · plastic

## ARGUS

ART.-NR. / CODE	LM / BULB	LEISTUNG / POWER	LUMEN	KELVIN	BxHxT / WxHxD	FARBE / COLOUR
653610106	SMD-LED	4 W	350	3.000	Ø 82 x 40 mm	Chrom · chrome
	RGB-LED	1 W				
653610131	SMD-LED	4 W	350	3.000	Ø 82 x 40 mm	Weiß matt · white mat
	RGB-LED	1 W				
653610132	SMD-LED	4 W	350	3.000	Ø 82 x 40 mm	Schwarz matt · black mat
	RGB-LED	1 W				

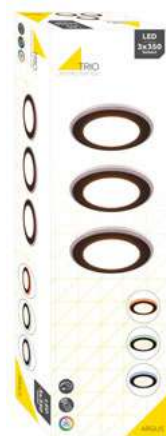

### Set 3

653610306 | Chrom · chrome

653610331 | Weiß matt · white mat

653610332 | Schwarz matt · black mat



07

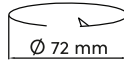
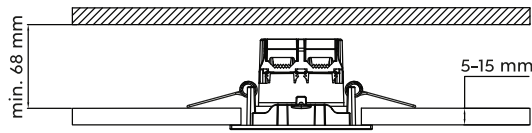

31



32



Dimmbar ·  
Dimmable

Metall · metal

## PAMIR

ART.-NR. / CODE	LM / BULB	LEISTUNG / POWER	LUMEN	KELVIN	BxHxD	FARBE / COLOUR
650510107	SMD-LED	5,5 W	345	3.000	Ø 85 x 54 mm	Nickel matt · nickel mat
650510131	SMD-LED	5,5 W	345	3.000	Ø 85 x 54 mm	Weiß matt · white mat
650510132	SMD-LED	5,5 W	345	3.000	Ø 85 x 54 mm	Schwarz matt · black mat



IP23



32

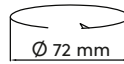
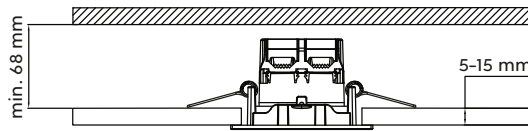

07



31



Dimmbar ·  
Dimmable

Metall · metal

## PAMIR

ART.-NR. / CODE	LM / BULB	LEISTUNG / POWER	LUMEN	KELVIN	BxHxD	FARBE / COLOUR
650410107	SMD-LED	5,5 W	345	3.000	85 x 85 x 54 mm	Nickel matt · nickel mat
650410131	SMD-LED	5,5 W	345	3.000	85 x 85 x 54 mm	Weiß matt · white mat
650410132	SMD-LED	5,5 W	345	3.000	85 x 85 x 54 mm	Schwarz matt · black mat



IP23

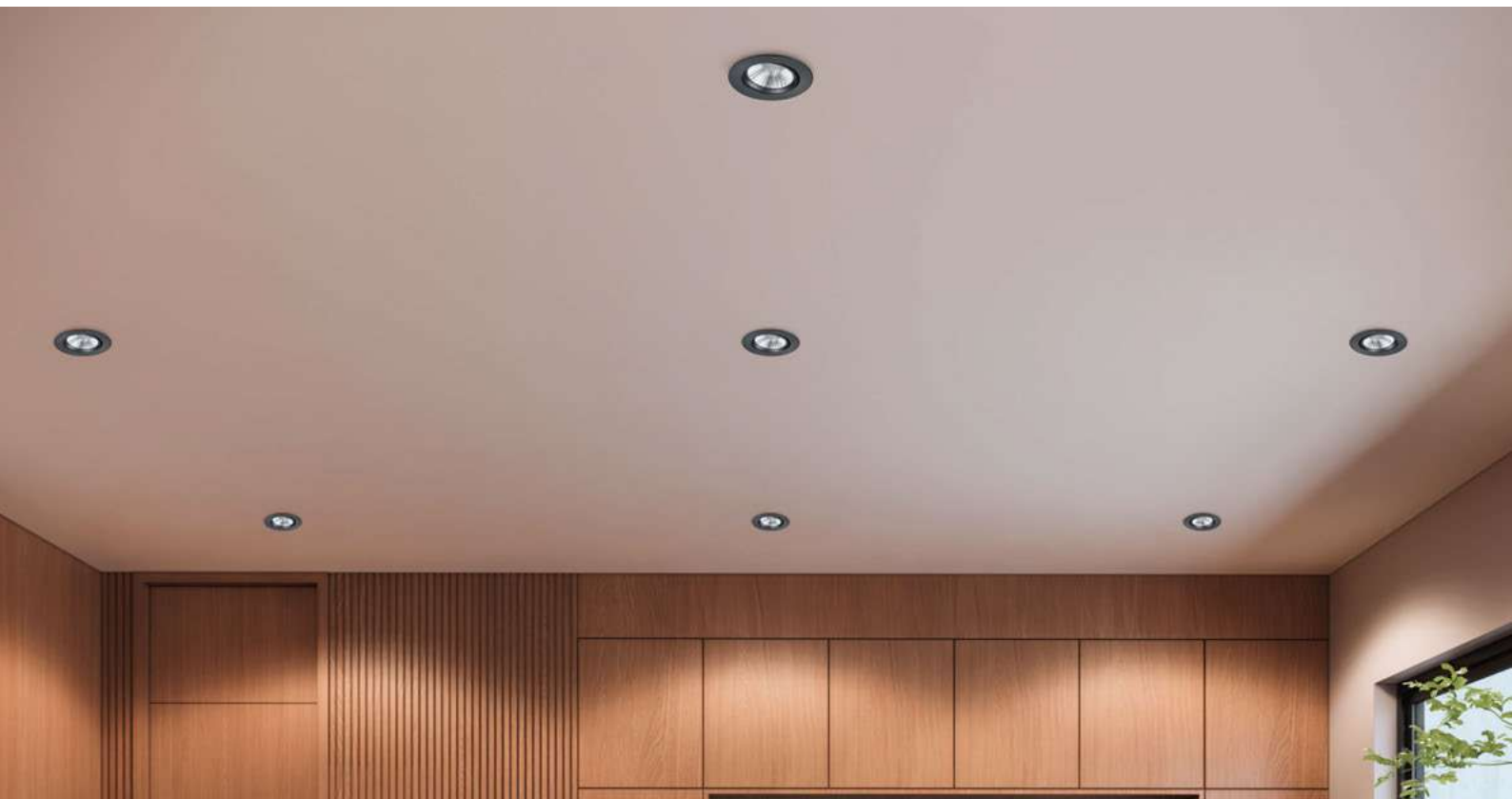





31

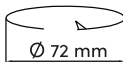
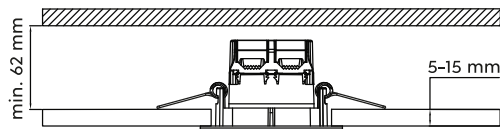

07



32



Dimmbar · Dimmable

Metall · metal

## ZAGROS

ART.-NR. / CODE	LM / BULB	LEISTUNG / POWER	LUMEN	KELVIN	BxHxT / WxHxD	FARBE / COLOUR
650710107	SMD-LED	5,5 W	345	3.000	Ø 85 x 54 mm	Nickel matt · nickel mat
650710131	SMD-LED	5,5 W	345	3.000	Ø 85 x 54 mm	Weiß matt · white mat
650710132	SMD-LED	5,5 W	345	3.000	Ø 85 x 54 mm	Schwarz matt · black mat



IP65



07

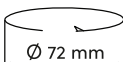
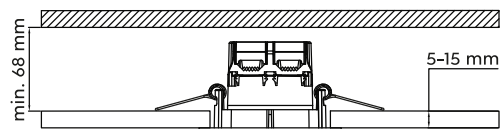

31



32



Dimmbar · Dimmable

Metall · metal

## ZAGROS

ART.-NR. / CODE	LM / BULB	LEISTUNG / POWER	LUMEN	KELVIN	BxHxT / WxHxD	FARBE / COLOUR
650610107	SMD-LED	5,5 W	345	3.000	85 x 85 x 54 mm	Nickel matt · nickel mat
650610131	SMD-LED	5,5 W	345	3.000	85 x 85 x 54 mm	Weiß matt · white mat
650610132	SMD-LED	5,5 W	345	3.000	85 x 85 x 54 mm	Schwarz matt · black mat



IP65

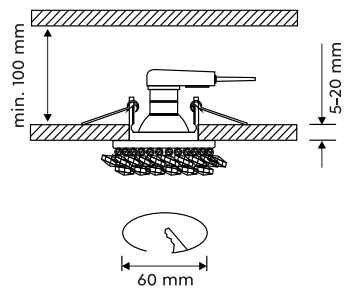

## DOLOMITE

Metall, Chrom, Kristallglas · metal, chrome, crystal glass

ART.-NR. / CODE	LM / BULB	LEISTUNG / POWER	LUMEN	KELVIN	BxHxT / WxHxD	FARBE / COLOUR
651700152	excl. 1 x GU10	max. 10 W			Ø 90 x 95 mm	Transparent klar · transparent clear
651800152	excl. 1 x GU10	max. 10 W			100 x 100 x 95 mm	Transparent klar · transparent clear

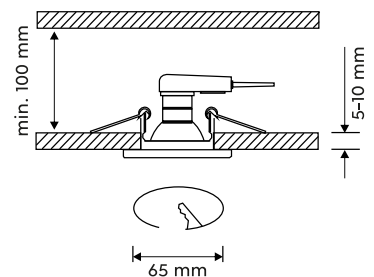
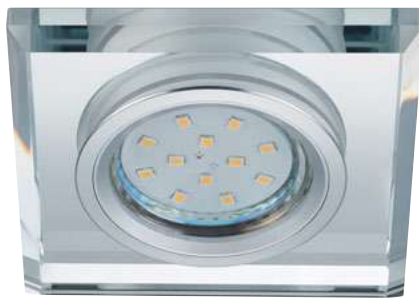

## PIRIN

Metall, Chrom, Kristallglas · metal, chrome, crystal glass

ART.-NR. / CODE	LM / BULB	LEISTUNG / POWER	LUMEN	KELVIN	BxHxT / WxHxD	FARBE / COLOUR
652100152	excl. 1 x GU10	max. 10 W			Ø 90 x 70 mm	Transparent klar · transparent clear
652200152	excl. 1 x GU10	max. 10 W			90 x 90 x 70 mm	Transparent klar · transparent clear





06

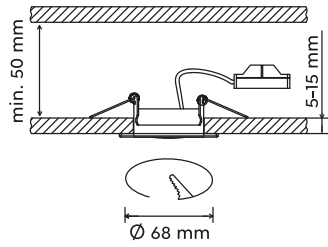

07

31



Schwenkbar ·  
Tilttable

## RILA

Metall · metal

ART.-NR. / CODE	LM / BULB	LEISTUNG / POWER	LUMEN	KELVIN	BxHxD / WxHxD	FARBE / COLOUR
650310106	SMD-LED	5 W	450	3.000	Ø 82 x 34 mm	Chrom · chrome
650310107	SMD-LED	5 W	450	3.000	Ø 82 x 34 mm	Nickel matt · nickel mat
650310131	SMD-LED	5 W	450	3.000	Ø 82 x 34 mm	Weiß matt · white mat



IP20





31



32

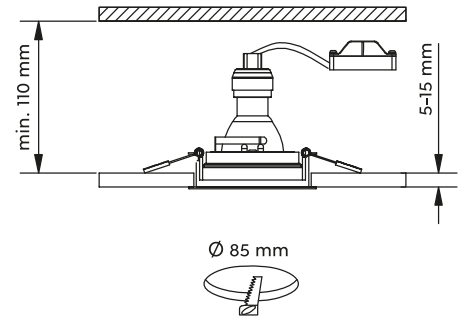

## KENAI



Schwenkbar ·  
Tiltable

Metall · metal

ART.-NR. / CODE	LM / BULB	LEISTUNG / POWER	LUMEN	KELVIN	BxHxD / WxHxD	FARBE / COLOUR
651500131	excl. 1 x GU10	max. 15 W			Ø 92 x 10 mm	Weiß matt · white mat
651500132	excl. 1 x GU10	max. 15 W			Ø 92 x 10 mm	Schwarz matt · black mat



31



32

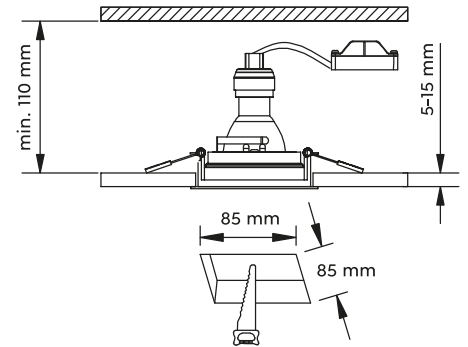

## KENAI



Schwenkbar ·  
Tiltable

Metall · metal

ART.-NR. / CODE	LM / BULB	LEISTUNG / POWER	LUMEN	KELVIN	BxHxD / WxHxD	FARBE / COLOUR
651600131	excl. 1 x GU10	max. 15 W			92 x 92 x 10 mm	Weiß matt · white mat
651600132	excl. 1 x GU10	max. 15 W			92 x 92 x 10 mm	Schwarz matt · black mat



32

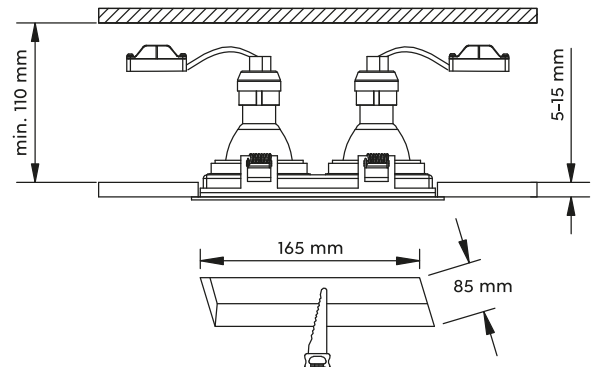

## KENAI



Schwenkbar ·  
Tiltable

Metall · metal

ART.-NR. / CODE	LM / BULB	LEISTUNG / POWER	LUMEN	KELVIN	BxHxD / WxHxD	FARBE / COLOUR
651600231	excl. 2 x GU10	max. 15 W			172 x 92 x 10 mm	Weiß matt · white mat
651600232	excl. 2 x GU10	max. 15 W			172 x 92 x 10 mm	Schwarz matt · black mat







**Set 3**

- 650100306 | Chrom · chrome
- 650100307 | Nickel matt · nickel mat
- 650100331 | Weiß matt · white mat



**Set 3**

- 650000306 | Chrom · chrome
- 650000307 | Nickel matt · nickel mat
- 650000331 | Weiß matt · white mat



06

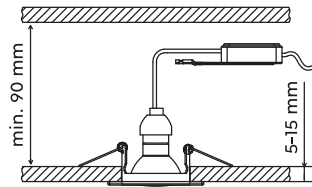

07



31



08



32



Schwenkbar · Tilttable

Metall · metal

## JURA

ART.-NR. / CODE	LM / BULB	LEISTUNG / POWER	LUMEN	KELVIN	BxHxD / WxHxD	FARBE / COLOUR
650100106	excl. 1 x GU10	max. 15 W			Ø 83 x 70 mm	Chrom · chrome
650100107	excl. 1 x GU10	max. 15 W			Ø 83 x 70 mm	Nickel matt · nickel mat
650100108	excl. 1 x GU10	max. 15 W			Ø 83 x 70 mm	Messing matt · brass mat
650100131	excl. 1 x GU10	max. 15 W			Ø 83 x 70 mm	Weiß matt · white mat
650100132	excl. 1 x GU10	max. 15 W			Ø 83 x 70 mm	Schwarz matt · black mat



IP20



08

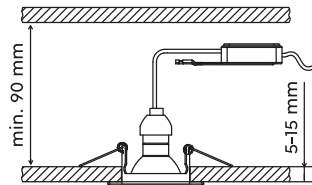

06



31



07



32



Schwenkbar · Tilttable

Metall · metal

## JURA

ART.-NR. / CODE	LM / BULB	LEISTUNG / POWER	LUMEN	KELVIN	BxHxD / WxHxD	FARBE / COLOUR
650000106	excl. 1 x GU10	max. 15 W			80 x 80 x 70 mm	Chrom · chrome
650000107	excl. 1 x GU10	max. 15 W			80 x 80 x 70 mm	Nickel matt · nickel mat
650000108	excl. 1 x GU10	max. 15 W			80 x 80 x 70 mm	Messing matt · brass mat
650000131	excl. 1 x GU10	max. 15 W			80 x 80 x 70 mm	Weiß matt · white mat
650000132	excl. 1 x GU10	max. 15 W			80 x 80 x 70 mm	Schwarz matt · black mat



IP20





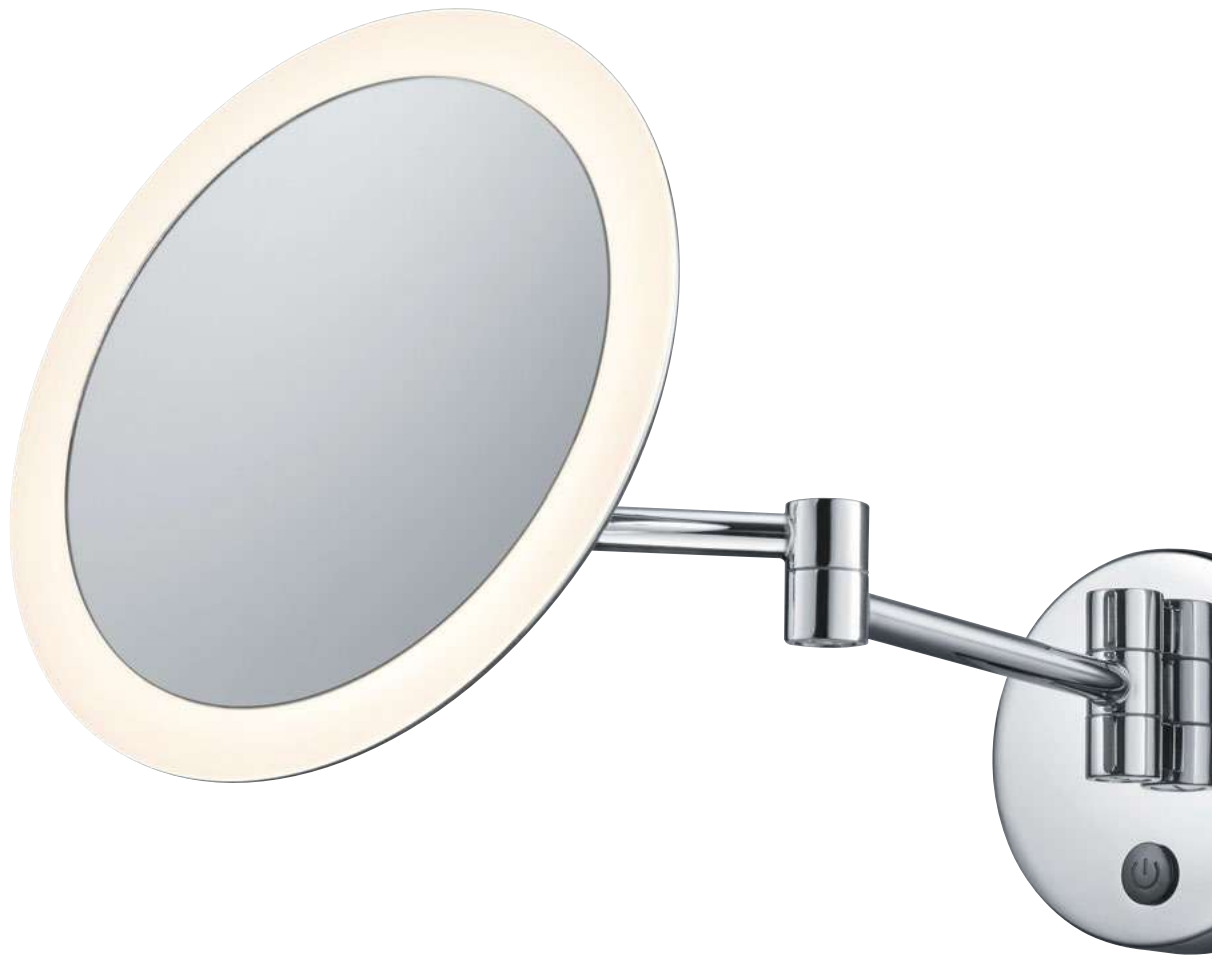

# BAD- LEUCHTEN

## BATHROOM LIGHTING

Badezimmerleuchten spielen eine entscheidende Rolle bei der Gestaltung eines gut beleuchteten und stilvollen Badezimmers. Sie bieten nicht nur die notwendige Helligkeit für tägliche Aktivitäten wie Rasieren, Schminken oder Zähneputzen, sondern tragen auch zur Schaffung einer entspannenden Atmosphäre bei.

Bathroom lights play a crucial role in creating a well-lit and stylish bathroom. They not only provide the necessary brightness for daily activities such as shaving, applying make-up or brushing teeth, but also help to create a relaxing atmosphere.



Sensordimmer ·  
Sensor dimmer



DIP SWITCH



Memory Funktion ·  
Memory function



Schwenkbar ·  
Tilttable

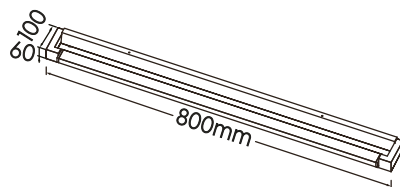
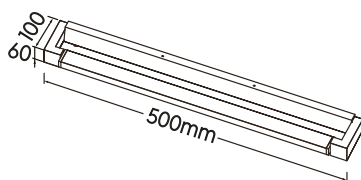

Wandleuchte · Wall lamp  
incl. SMD-LED  
9 W / 1.000 Lumen  
2.300 + 3.000 + 4.000 Kelvin  
**284770106**  
**284770132**



IP44

Wandleuchte · Wall lamp  
incl. SMD-LED  
15 W / 1.700 Lumen  
2.300 + 3.000 + 4.000 Kelvin  
**284779106**  
**284779132**



IP44

Metall, Kunststoff · metal, plastic



**06** | Chrome · chrome



**32** | Schwarz matt · black mat

# FABRIZIO NEW

Die Spiegelleuchte FABRIZIO bietet durch ihre schwenkbare Ausrichtung und einstellbare Lichtfarbe maximale Flexibilität. Diese Anpassungsfähigkeit macht sie zu einer idealen Wahl für jedes moderne Badezimmer.

The FABRIZIO mirror light offers maximum flexibility thanks to its swivelling alignment and adjustable light colour. This adaptability makes it an ideal choice for any modern bathroom.



# FABIO

Metall, Kunststoff · metal, plastic

06 | Chrome · chrome

32 | Schwarz matt · black mat

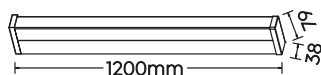
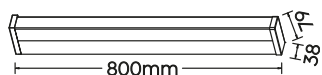
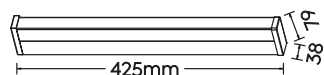

Wandleuchte · Wall lamp

incl. SMD-LED  
6 W / 750 Lumen  
3.000 Kelvin

283814206  
283814232

Wandleuchte · Wall lamp

incl. SMD-LED  
12 W / 1.400 Lumen  
3.000 Kelvin

283817906  
283817932

Wandleuchte · Wall lamp

incl. SMD-LED  
22 W / 2.500 Lumen  
3.000 Kelvin

283811206  
283811232





# ROCCO

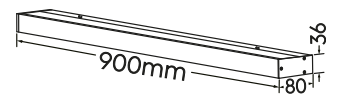
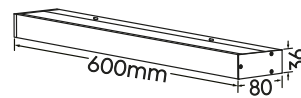

Aluminium, Kunststoff ·  
aluminium, plastic



**06** | Chrome · chrome



**32** | Schwarz matt · black mat

Wandleuchte · Wall lamp  
incl. SMD-LED  
8 W / 800 Lumen  
3.000 Kelvin  
**283916006**  
**283916032**



Wandleuchte · Wall lamp  
incl. SMD-LED  
13 W / 1.400 Lumen  
3.000 Kelvin  
**283919006**  
**283919032**





# ENRICO NEW

Die perfekte Spiegelbeleuchtung vereint Design und Funktionalität. ENRICO bietet nicht nur eine optimale Ausleuchtung, sondern ermöglicht auch, die Einstellung der Lichtfarbe je nach Bedarf.

The perfect mirror lighting combines design and functionality. ENRICO not only provides optimum illumination, but also allows the light colour to be adjusted as required.

Metall, Kunststoff · metal, plastic

 **06** | Chrome · chrome

 **32** | Schwarz matt · black mat



 Getrennt schaltbar · Separately switchable

 Lichtfarbe einstellbar · Adjustable light color

 Memory Funktion · Memory function

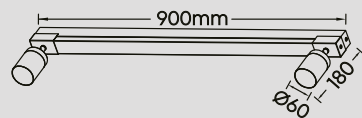
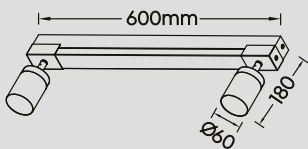

Wandleuchte · Wall lamp  
incl. SMD-LED  
6 W / 620 Lumen  
2.300 + 3.000 + 4.000 Kelvin  
excl. 2 x GU10  
max. 5 W  
**281470306**  
**281470332**

Wandleuchte · Wall lamp  
incl. SMD-LED  
9 W / 1.200 Lumen  
2.300 + 3.000 + 4.000 Kelvin  
excl. 2 x GU10  
max. 5 W  
**281479306**  
**281479332**

Empfohlen:  
recommended:

LED GU10  
4,5 W / 345 Lumen  
3.000 Kelvin  
**956-5736**





# PIERA

Die Spiegelleuchte PIERA vereint elegantes Design mit praktischer Funktionalität. Mit einer maximalen Länge von 119 cm passt sie sich hervorragend großen oder kleinen Spiegelflächen an. Ein besonderes Merkmal ist die integrierte Schuko Steckdose, die den Anschluss von Haartrocknern oder Rasierern ermöglicht.

The PIERA mirror light combines elegant design with practical functionality. With a maximum length of 119 cm, it adapts perfectly to large or small mirror surfaces. A special feature is the integrated Schuko socket, which allows hairdryers or shavers to be connected.



Kunststoff · plastic

06 | Chrome · chrome

32 | Schwarz matt · black mat

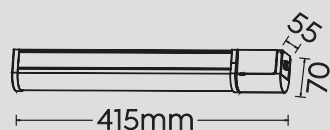

Wandleuchte · Wall lamp

incl. SMD-LED  
8 W / 850 Lumen  
3.000 Kelvin

284074206  
284074232

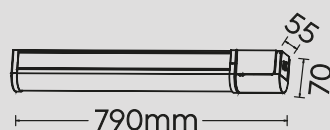

Wandleuchte · Wall lamp

incl. SMD-LED  
16 W / 1.650 Lumen  
3.000 Kelvin

284077906  
284077932



Wandleuchte · Wall lamp

incl. SMD-LED  
21 W / 2.200 Lumen  
3.000 Kelvin

284071206  
284071232





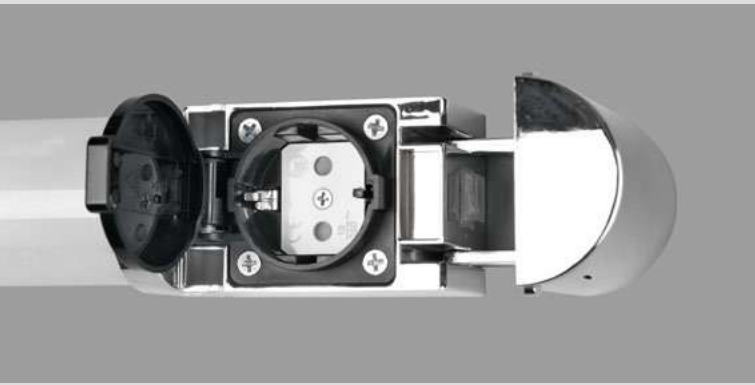

# ANGELO

Die Spotserie ANGELO ist eine innovative Beleuchtungslösung, die eine gezielte Lichtverteilung ermöglicht. Die sorgfältige Anordnung dieser Spots kann dazu beitragen, eine stimmungsvolle Atmosphäre zu schaffen, die das Bad in eine entspannende Oase verwandelt.

The ANGELO spotlight range is an innovative lighting solution that enables targeted light distribution. The careful arrangement of these spotlights can help to create an atmospheric ambience that transforms the bathroom into a relaxing oasis.

Metall · metal

06 | Chrome · chrome

32 | Schwarz matt · black mat



Empfohlen:  
recommended:

LED GU10  
4,5 W / 345 Lumen  
3.000 Kelvin

**956-5736**

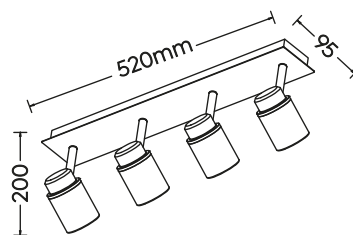
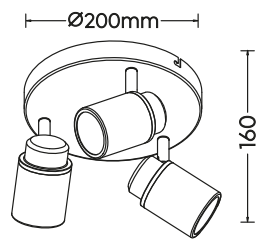
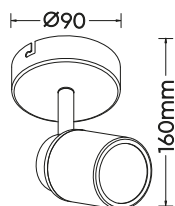

Strahler · Spot  
excl. 1 x GU10  
max. 5 W  
**880400106**  
**880400132**

Strahler · Spot  
excl. 3 x GU10  
max. 5 W  
**880430306**  
**880430332**

Strahler · Spot  
excl. 4 x GU10  
max. 5 W  
**880400406**  
**880400432**





# BOLSA

Die Kombination aus glänzendem Chrom und klarem Acryl schafft eine moderne und zeitlose Ästhetik. Die eingeschlossenen Luftblasen fangen das Licht auf faszinierende Weise ein und sorgen für effektvolle Reflexionen.

The combination of shiny chrome and clear acrylic creates a modern and timeless aesthetic. The enclosed air bubbles catch the light in a fascinating way and create effective reflections.

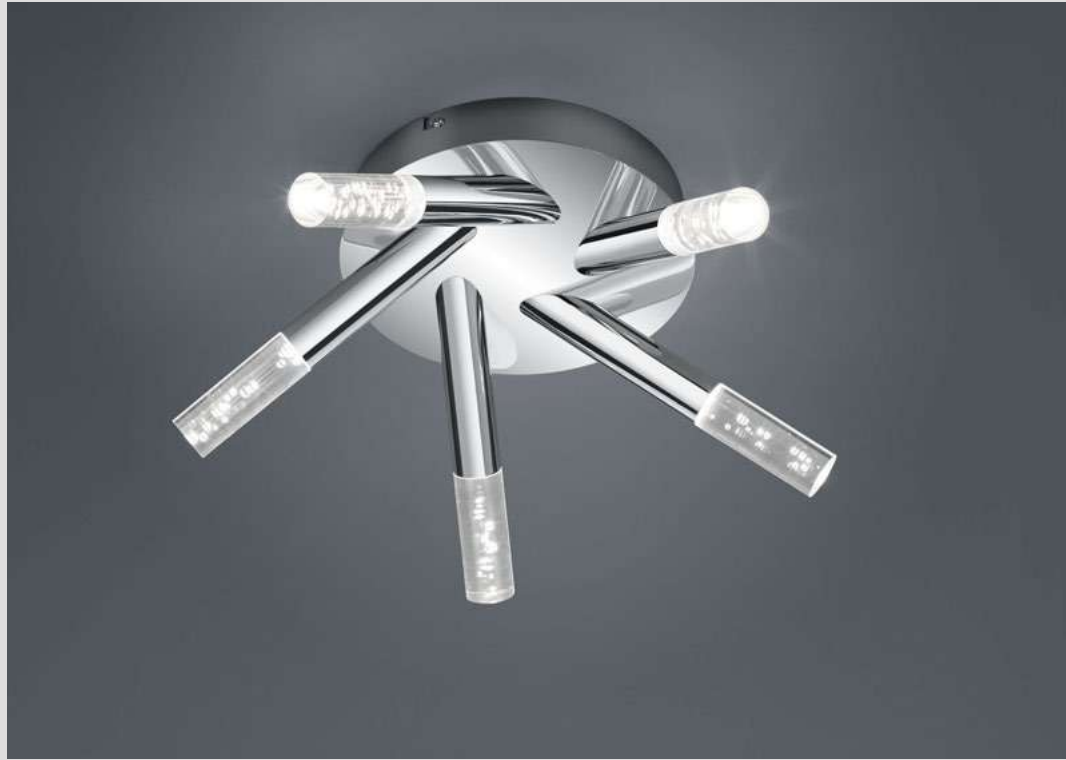

Metall, Acryl · metal, acryl



06 | Chrome · chrome

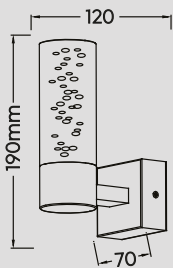

Wandleuchte · Wall lamp  
incl. OSRAM-LED  
3,1 W / 310 Lumen  
3.000 Kelvin  
**282410106**

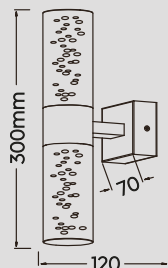

Wandleuchte · Wall lamp  
incl. OSRAM-LED  
2 x 3,1 W / 2 x 310 Lumen  
3.000 Kelvin  
**282410206**

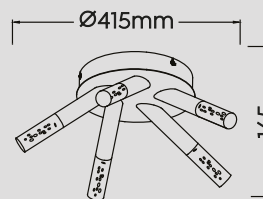

Deckenleuchte · Ceiling lamp  
incl. OSRAM-LED  
5 x 3,1 W / 5 x 310 Lumen  
3.000 Kelvin  
**682410506**





# RAY

Kunststoff · plastic

 **06** | Chrome · chrome

 **32** | Schwarz matt · black mat

Wandleuchte · Wall lamp

incl. 2 x SMD-LED  
2 x 4 W / 2 x 340 Lumen  
3.000 Kelvin

**283110206**

**283110232**

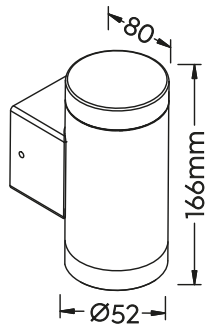



# KULA

Metall, Glas Weiß · metal, glass white

06 | Chrome · chrome

32 | Schwarz matt · black mat

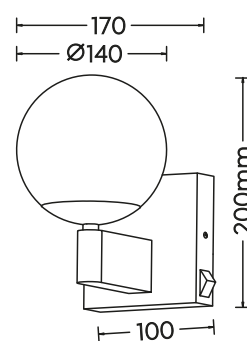

Wandleuchte · Wall lamp

excl. 1 x E14

max. 10 W

284270106

284270132



# THEATRO

Metall · metal



06 | Chrome · chrome

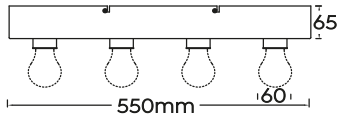
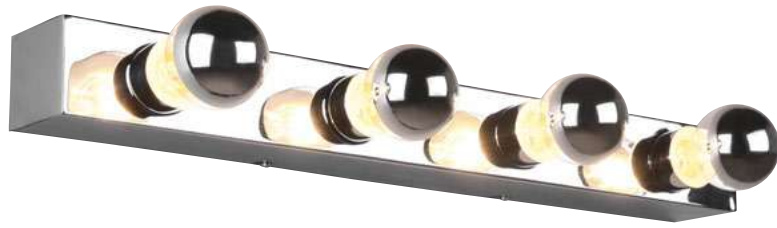

Wandleuchte · Wall lamp

excl. 4 x E27

max. 10 W

283600406



IP44



Empfohlen:  
recommended:

Filament LED E27  
4 W / 430 Lumen  
2.700 Kelvin

**987-410**







Empfohlen:  
recommended:

Filament LED E27  
4 W / 470 Lumen  
2.700 Kelvin  
**987-479**

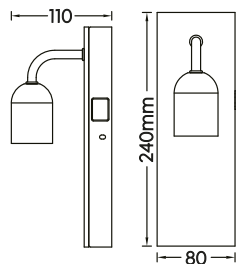

Deckenleuchte · Ceiling lamp  
excl. 1 x E27  
max. 10 W  
**284470132**

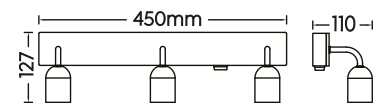

Deckenleuchte · Ceiling lamp  
excl. 3 x E27  
max. 10 W  
**284470332**



# ARTURO NEW

Metall, Holz · metal, wood

**32** | Schwarz matt · black mat

# GIANNI

Metall · metal

06 | Chrome · chrome

32 | Schwarz matt · black mat

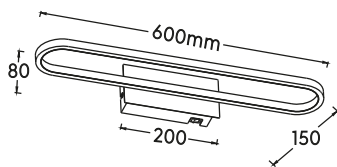
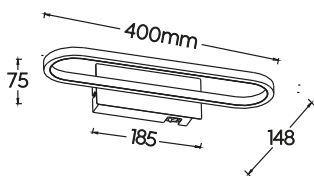

Wandleuchte · Wall lamp

incl. SMD-LED  
17 W / 1.700 Lumen  
3.000 Kelvin

283770106  
283770132



Wandleuchte · Wall lamp

incl. SMD-LED  
22 W / 2.700 Lumen  
3.000 Kelvin

283779106  
283779132



VIEW

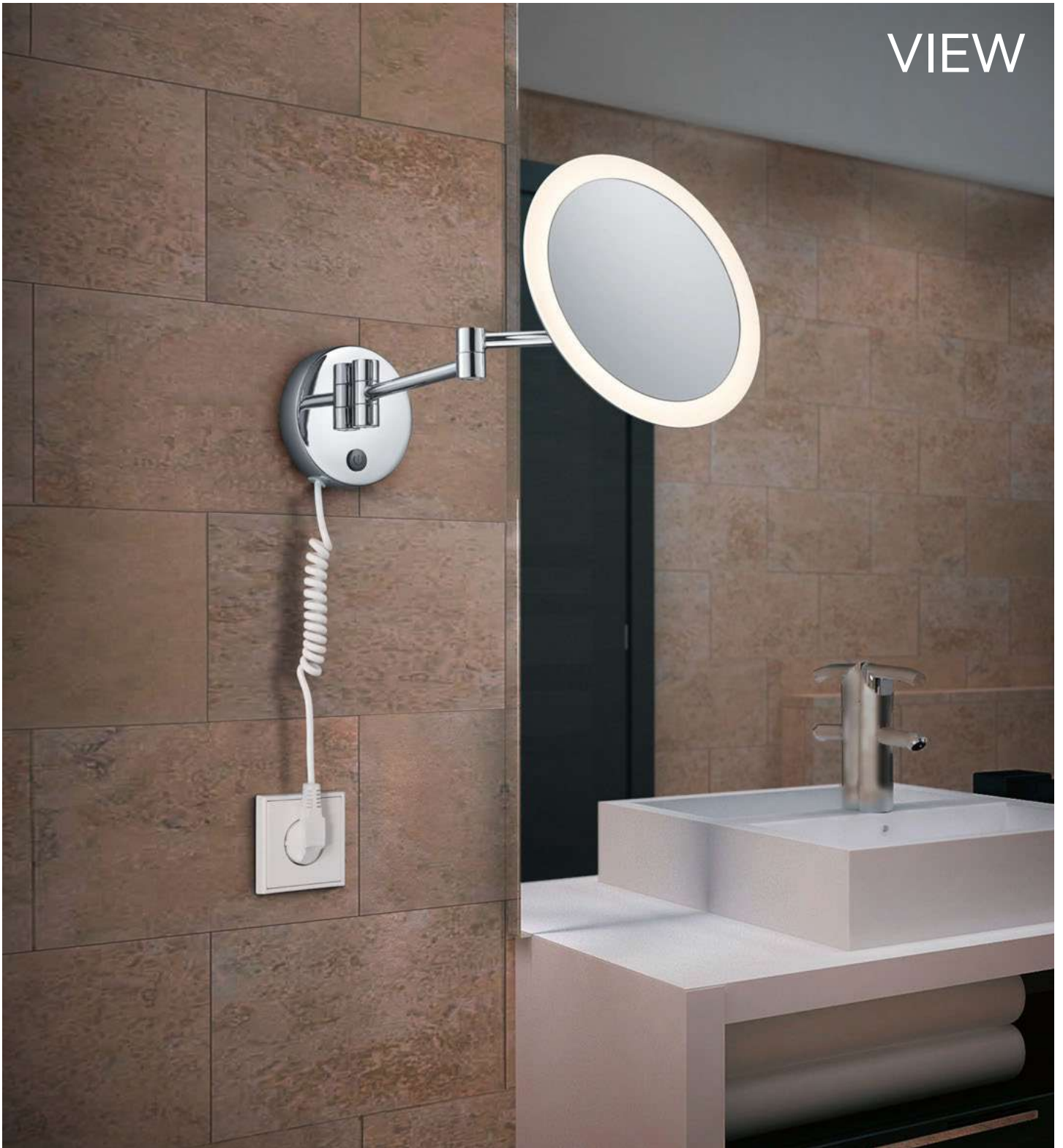

Metall, Acryl · metal, acryl



06 | Chrome · chrome

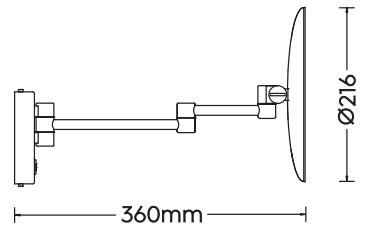

Wandleuchte · Wall lamp

incl. SMD-LED  
3 W / 280 Lumen  
3.000 Kelvin  
**282990106**



On/Off Touch Funktion ·  
On/Off Touch function



Vergrößerung 3x ·  
Magnification 3x



IP44

# MATTIMO

Eine minimalistische Beleuchtungslösung, die sich nahtlos in jedes Badezimmerdesign einfügt. Ihre schlanke Form und die verschiedenen Längen der Leuchten, sorgen für eine effiziente und zugleich stilvolle Beleuchtung,

A minimalist lighting solution that blends seamlessly into any bathroom design. Its slim shape and the different lengths of the lights ensure efficient yet stylish lighting,



Metall, Kunststoff · metal, plastic

 06 | Chrome · chrome

 32 | Schwarz matt · black mat

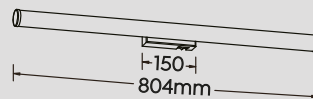
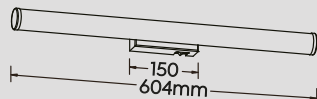
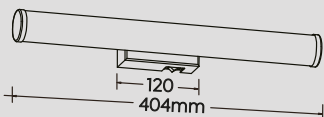

Wandleuchte · Wall lamp

incl. SMD-LED  
4,3 W / 450 Lumen  
3.000 Kelvin

**283270106**  
**283270132**



Wandleuchte · Wall lamp

incl. SMD-LED  
6,5 W / 680 Lumen  
3.000 Kelvin

**283270206**  
**283270232**



Wandleuchte · Wall lamp

incl. SMD-LED  
8,6 W / 880 Lumen  
3.000 Kelvin

**283270306**  
**283270332**



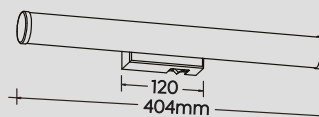

Wandleuchte · Wall lamp  
incl. SMD-LED  
4,3 W / 500 Lumen  
4.000 Kelvin  
**283274106 NEW**

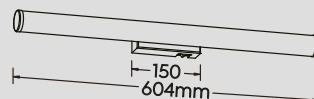

Wandleuchte · Wall lamp  
incl. SMD-LED  
6,5 W / 750 Lumen  
4.000 Kelvin  
**283274206 NEW**

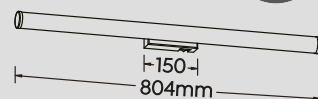

Wandleuchte · Wall lamp  
incl. SMD-LED  
8,6 W / 950 Lumen  
4.000 Kelvin  
**283274306 NEW**



# LINO

Die innovative Beleuchtungslösung LINO bietet mit ihren drei verschiedenen Montagemöglichkeiten ein Höchstmaß an Flexibilität.

With its three different mounting options, the innovative LINO lighting solution offers maximum flexibility.

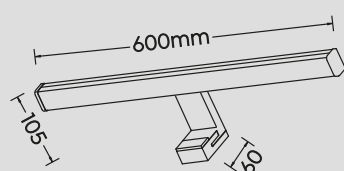
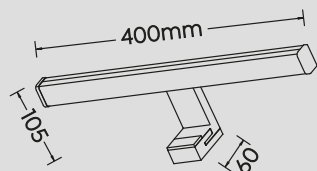

Wandleuchte · Wall lamp

incl. SMD-LED  
7,4 W / 900 Lumen  
3.000 Kelvin  
**284114006**  
**284114032**



Wandleuchte · Wall lamp

incl. SMD-LED  
11 W / 1.350 Lumen  
3.000 Kelvin  
**284116006**  
**284116032**



Kunststoff · plastic



**06** | Chrome · chrome



**32** | Schwarz matt · black mat



Zur Montage direkt an der Wand, auf dem Spiegelschrank oder als Klemmleuchte am Spiegel.  
For mounting directly on the wall, on the mirror cabinet or as a clamp light on the mirror.

# LORENZO

Eine innovative Beleuchtungslösung, die speziell für die einfache Montage an Spiegeln konzipiert wurde. Sie lässt sich ohne Werkzeug oder technisches Know-How befestigen.

An innovative lighting solution specially designed for easy installation on mirrors. It can be attached without tools or technical expertise.

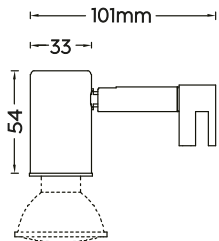

Strahler · Spot  
excl. 1 x GU10  
max. 5 W  
**283500106**  
**283500132**



Metall · metal

 **06** | Chrome · chrome

 **32** | Schwarz matt · black mat

Empfohlen:  
recommended:



LED GU10  
4,5 W / 345 Lumen  
3.000 Kelvin  
**956-5736**







# GIADA

GIADA eignet sich besonders für die Installation an Spiegelschränken. Mit ihrer filigranen Form fügt sie sich nahtlos in moderne Badezimmer ein und bietet durch den neigbaren Spot eine flexible Beleuchtungslösung.

GIADA is particularly suitable for installation on mirror cabinets. With its delicate shape, it blends seamlessly into modern bathrooms and offers a flexible lighting solution thanks to the tilting spotlight.

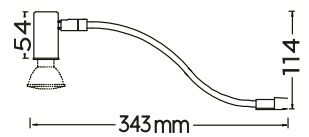

Empfohlen:  
recommended:



LED GU10  
4,5 W / 345 Lumen  
3.000 Kelvin  
**956-5736**



Metall · metal



**06** | Chrome · chrome



**32** | Schwarz matt · black mat

Strahler · Spot  
excl. 1 x GU10  
max. 5 W  
**283400106**  
**283400132**



IP44

# CLARIMO

Die Deckenleuchte CLARIMO zeichnet sich durch ihr zeitloses Design aus, das sich nahtlos in moderne Badezimmer einfügt. Fest verbaute LEDs in Kombination mit dem weißen Diffusor bieten eine gleichmäßige Lichtverteilung.

The CLARIMO ceiling light is characterised by its timeless design, which blends seamlessly into modern bathrooms. Permanently installed LEDs in combination with the white diffuser provide uniform light distribution.



Kunststoff · plastic



**01** | Weiß · white



**06** | Chrome · chrome



**32** | Schwarz matt · black mat



**87** | titanfarbig · titan



Deckenleuchte · Ceiling lamp

incl. SMD-LED  
18 W / 1.850 Lumen  
3.000 Kelvin

**659011801**

**659011806**

**659011832**

**659011887**

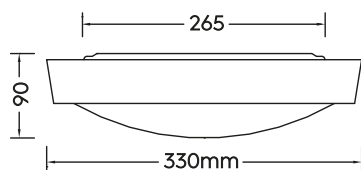

IP44



Metall, Acryl · metal, acryl



**06** | Chrome · chrome



**32** | Schwarz matt · black mat

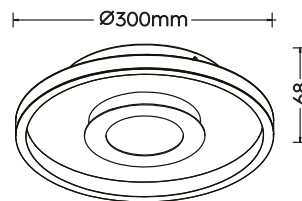

Deckenleuchte · Ceiling lamp

incl. SMD-LED  
28 W / 3.200 Lumen  
3.000 Kelvin

**680810306**  
**680810332**



IP44

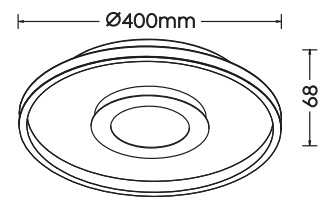

Deckenleuchte · Ceiling lamp

incl. SMD-LED  
35 W / 4.100 Lumen  
3.000 Kelvin

**680819306**  
**680819332**



IP44

# ASCARI

# APART

Kunststoff · plastic



06 | Chrome · chrome

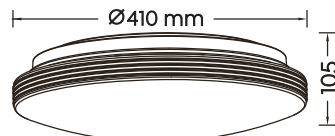
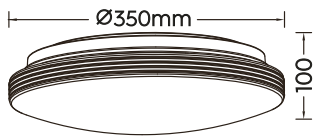

Deckenleuchte · Ceiling lamp

incl. SMD-LED  
18 W / 1.850 Lumen  
3.000 Kelvin  
659411806



Deckenleuchte · Ceiling lamp

incl. SMD-LED  
22 W / 2.500 Lumen  
3.000 Kelvin  
659412406



# UMBERTO

Kunststoff · plastic



06 | Chrome · chrome



32 | Schwarz matt · black mat

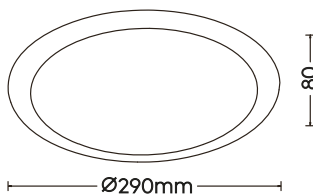

Deckenleuchte · Ceiling lamp

incl. SMD-LED  
12 W / 1.160 Lumen  
3.000 Kelvin  
680310106  
680310132



# CAMILLA

Kunststoff · plastic

32 | Schwarz matt · black mat



## SWITCH DIMMER

Helligkeit in 3 Stufen mit herkömmlichem Lichtschalter einstellbar.

Brightness adjustable in 4 levels with conventional light switch.

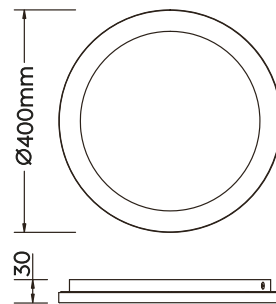

Deckenleuchte · Ceiling lamp  
incl. SMD-LED  
22 W / 2.700 Lumen  
3.000 Kelvin  
689214032

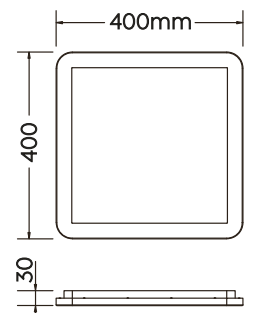

Deckenleuchte · Ceiling lamp  
incl. SMD-LED  
22 W / 2.700 Lumen  
3.000 Kelvin  
689314032



# XAVI



Wandleuchte · Wall lamp  
excl. 2 x E14  
max. 40 W  
**2803021-06**



Wandleuchte · Wall lamp  
excl. 3 x E14  
max. 40 W  
**2803031-06**



Metall, Glas satiniert ·  
metal, satinated glass



**06** | Chrome · chrome



Empfohlen:  
recommended:

Filament LED E14  
4 W / 470 Lumen  
2.700 Kelvin

**989-400**

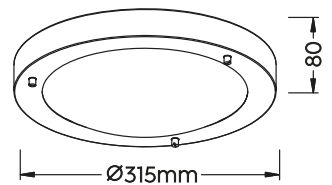

Metall, Glas opal · metal, opal glass



**01** | Weiß · white



**06** | Chrome · chrome



**07** | Nickel matt · nickel mat



**32** | Schwarz matt · black mat



Empfohlen:  
recommended:

Filament LED E27  
4 W / 470 Lumen  
2.700 Kelvin

**987-400**

Deckenleuchte · Ceiling lamp

excl. 1 x E27  
max. 60 W

**6801011-01**  
**6801011-06**  
**6801011-07**  
**6801011-32**



# FRODENO

Kunststoff · plastic

00 | Transparent · transparent



## RGBW Farbwechsler

Diese Leuchte verfügt über einen RGBW-Farbwechsler (rot, grün, blau, weiß).

## RGBW Colorchanging

This light fitting has an RGBW (red, green, blue, white) colour change module.

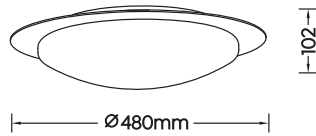
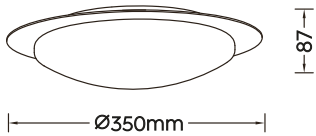

Deckenleuchte · Ceiling lamp

incl. RGBW-LED  
12 W / 1.200 Lumen  
4.000 Kelvin  
**680213500**



Deckenleuchte · Ceiling lamp

incl. RGBW-LED  
18,5 W / 1.900 Lumen  
4.000 Kelvin  
**680214800**



# PAOLO

Kunststoff · plastic

00 | Transparent · transparent

01 | Weiß · white

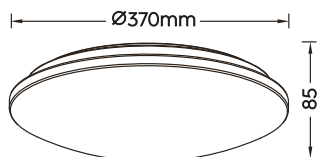
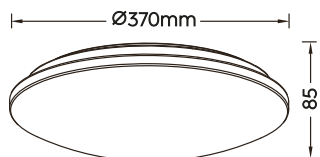

Deckenleuchte · Ceiling lamp

incl. SMD-LED  
15 W / 1.500 Lumen  
3.000 Kelvin  
**686014001**



Deckenleuchte · Ceiling lamp

incl. SMD-LED  
15 W / 1.500 Lumen  
4.000 Kelvin  
**686014000**







## Übersicht der LED-Lampensockel · Overview of LED lamp bases

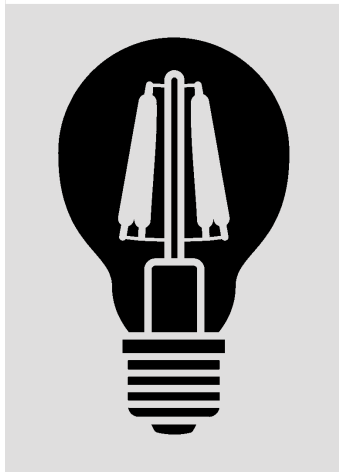

E27  
Schraubsockel  
Screw base

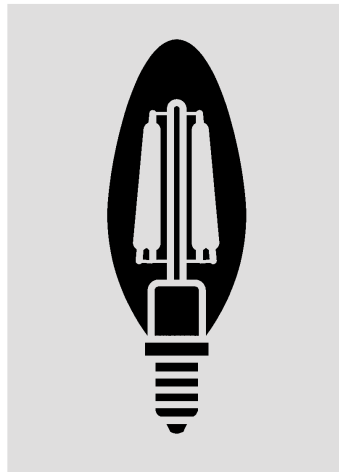

E14  
Schraubsockel  
Screw base

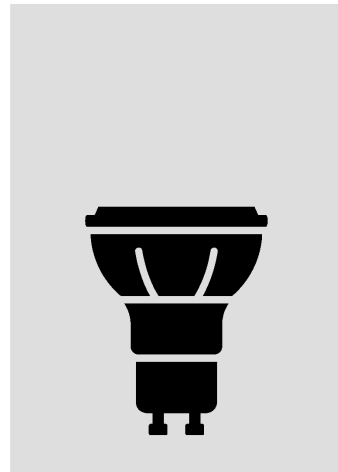

GU10  
Stecksockel  
Pin base

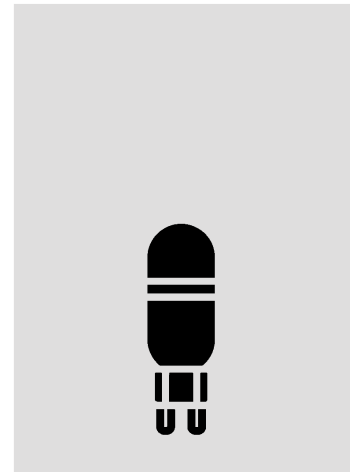

G9  
Stecksockel  
Pin base

## Farbtemperaturskala · Colour temperature scale (Kelvin)



2.700 - 3.300 Kelvin  
Warmweiß · warm white

3.300 - 5.300 Kelvin  
Neutralweiß · bright white

5.300 - 7.000 Kelvin  
Tageslichtweiß · daylight

## Übersicht Eigenschaften · Feature overview



Stufenlos dimmbar mit  
herkömmlichem Lichtregler.

Continuously dimmable with  
conventional light controller.



Switch Dim to Warm

Helligkeit und Lichtfarbe in  
3 Stufen mit herkömmlichem  
Lichtschalter einstellbar.

Brightness and light colour  
adjustable in 3 levels with  
conventional light switch.

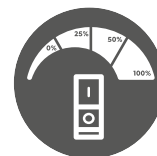

Switch Dimmer

Helligkeit in 3 Stufen mit  
herkömmlichem Lichtschalter  
einsetzbar.

Brightness adjustable in 3 levels  
with conventional light switch.



# LEUCHTMITTEL

## LIGHT SOURCES

LED-Leuchtmittel bieten eine Vielfalt an Formen und Sockeln, die sich perfekt an jede Leuchte und jeden Raum anpassen lassen. Ob klassische Glühbirnenform, moderne Spots oder dekorative Filament-Designs – die Auswahl ist nahezu unbegrenzt. Auch bei den Sockeln gibt es zahlreiche Varianten, wie E27, E14, GU10 oder G9, die für unterschiedliche Lampenfassungen geeignet sind.

LED light sources offer a variety of shapes and bases that can be perfectly adapted to any luminaire and any room. Whether classic bulb shapes, modern spotlights or decorative filament designs – the choice is almost unlimited. There are also numerous variants of bases, such as E27, E14, GU10 or G9, which are suitable for different lamp holders.

# LED-LEUCHTMITTEL E27

LED bulbs E27 · Ampoules LED E27 · LED-lampen E27 · Bombillas a LED E27 ·  
Lampadine a LED E27 · Becuri cu LED-uri E27 · LED-Valonlähdeet E27 · Żarówki LED E27

Code	Socket	Power	Lumen	Kelvin	Lifetime	Dimmable	Switch Dimmer	Switch Dim To Warm
------	--------	-------	-------	--------	----------	----------	---------------	--------------------

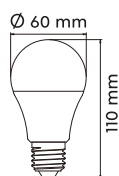

987-60	E27	4,9 W	470 lm	3.000 K	25.000 h			
988-700	E27	6,5 W	560 lm	3.000 K	25.000 h	✓		
988-10	E27	8,5 W	806 lm	3.000 K	25.000 h		✓	
988-110	E27	8,5 W	806 lm	3.000 K	25.000 h	✓		

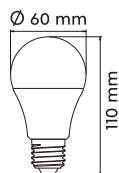

987-909	E27	9 W	806 lm	2.200 K	25.000 h			✓
				2.700 K				
				3.000 K				

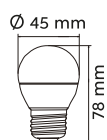

986-40	E27	3,5 W	320 lm	3.000 K	25.000 h			
986-60	E27	4,9 W	470 lm	3.000 K	25.000 h			

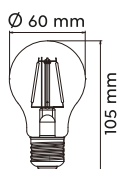

987-400	clear	E27	4 W	470 lm	2.700 K	15.000 h		
987-6810	clear	E27	7 W	806 lm	2.700 K	15.000 h	✓	

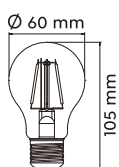

987-7009	clear	E27	7 W	806 lm	2.200 K	10.000 h		✓
				2.700 K				
				3.000 K				

Code	Socket	Power	Lumen	Kelvin	Lifetime	Dimmable	Switch Dimmer	Switch Dim To Warm
------	--------	-------	-------	--------	----------	----------	---------------	--------------------

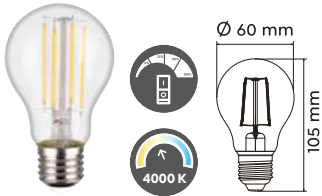

987-740	clear	E27	7 W	806 lm	4.000 K	25.000 h		✓
---------	-------	-----	-----	--------	---------	----------	--	---

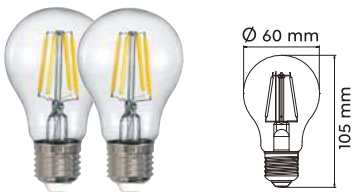

**Set 2**

987-2400	clear	E27	4 W	470 lm	2.700 K	10.000 h		
----------	-------	-----	-----	--------	---------	----------	--	--

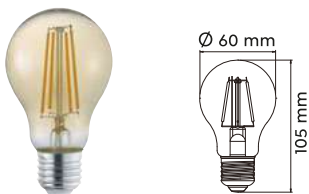

987-479	amber	E27	4 W	470 lm	3.000 K	10.000 h		
987-6700	amber	E27	7 W	700 lm	2.700 K	10.000 h		✓

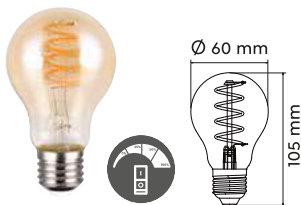

**Deko-Filament**

986-4813	amber	E27	7 W	400 lm	1.800 K	25.000 h		✓
----------	-------	-----	-----	--------	---------	----------	--	---

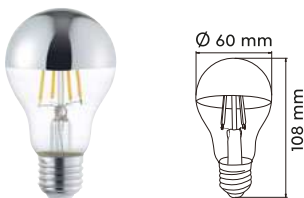

987-410	chrom	E27	4 W	430 lm	2.700 K	10.000 h		
---------	-------	-----	-----	--------	---------	----------	--	--

# LED-LEUCHTMITTEL E27

LED bulbs E27 · Ampoules LED E27 · LED-lampen E27 · Bombillas a LED E27 ·  
Lampadine a LED E27 · Becuri cu LED-uri E27 · LED-Valonlähdeet E27 · Żarówki LED E27

Code	Socket	Power	Lumen	Kelvin	Lifetime	Dimmable	Switch Dimmer	Switch Dim To Warm
------	--------	-------	-------	--------	----------	----------	---------------	--------------------



988-901	E27	9 W	1.055 lm	3.000 K	25.000 h		✓	
---------	-----	-----	----------	---------	----------	--	---	--

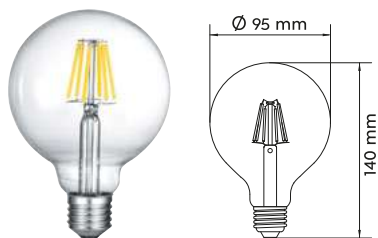

988-600	clear	E27	7 W	806 lm	2.700 K	10.000 h		
985-6810	clear	E27	7 W	806 lm	2.700 K	10.000 h	✓	

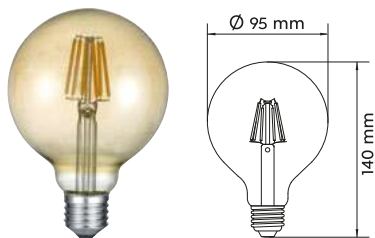

988-679	amber	E27	6 W	660 lm	2.700 K	10.000 h		
---------	-------	-----	-----	--------	---------	----------	--	--

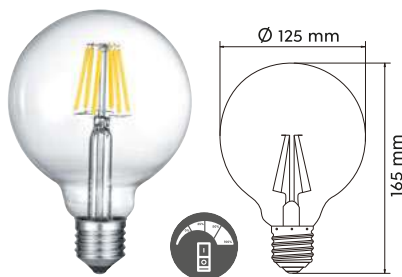

986-6810	clear	E27	7 W	806 lm	2.700 K	10.000 h		✓
----------	-------	-----	-----	--------	---------	----------	--	---

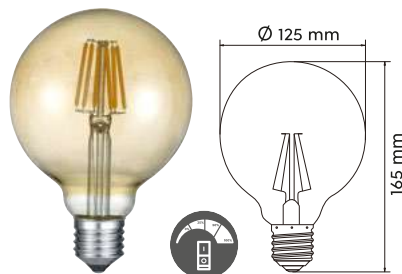

986-6790	amber	E27	8 W	806 lm	2.700 K	10.000 h		✓
----------	-------	-----	-----	--------	---------	----------	--	---

Code	Socket	Power	Lumen	Kelvin	Lifetime	Dimmable	Switch Dimmer	Switch Dim To Warm
------	--------	-------	-------	--------	----------	----------	---------------	--------------------

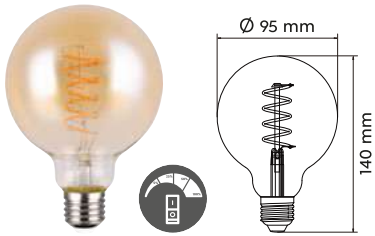

**Deko-Filament**

988-4813	amber	E27	7 W	400 lm	1.800 K	25.000 h		✓	
----------	-------	-----	-----	--------	---------	----------	--	---	--

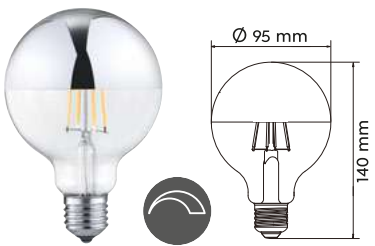

988-710	chrom	E27	7 W	680 lm	2.700 K	10.000 h	✓		
---------	-------	-----	-----	--------	---------	----------	---	--	--

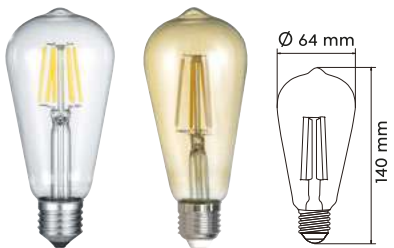

987-600	clear	E27	7 W	806 lm	2.700 K	10.000 h			
987-679	amber	E27	6 W	600 lm	2.700 K	10.000 h			

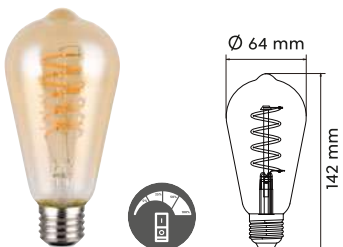

**Deko-Filament**

987-4813	amber	E27	7 W	500 lm	1.800 K	25.000 h		✓	
----------	-------	-----	-----	--------	---------	----------	--	---	--

# LED-LEUCHTMITTEL E27

LED bulbs E27 · Ampoules LED E27 · LED-lampen E27 · Bombillas a LED E27 ·  
Lampadine a LED E27 · Becuri cu LED-uri E27 · LED-Valonlähdeet E27 · Żarówki LED E27

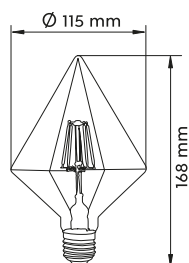

Code	Socket	Power	Lumen	Kelvin	Lifetime	Dimmable	Switch Dimmer	Switch Dim To Warm
------	--------	-------	-------	--------	----------	----------	---------------	--------------------

901-479	amber	E27	4 W	360 lm	2.700 K	10.000 h		
---------	-------	-----	-----	--------	---------	----------	--	--

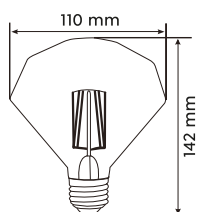

902-479	amber	E27	4 W	360 lm	2.700 K	10.000 h		
---------	-------	-----	-----	--------	---------	----------	--	--

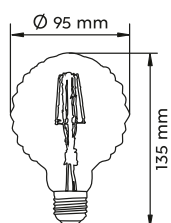

904-479	amber	E27	4 W	320 lm	2.700 K	10.000 h		
---------	-------	-----	-----	--------	---------	----------	--	--



# LED-LEUCHTMITTEL E14

LED bulbs E14 · Ampoules LED E14 · LED-lampen E14 · Bombillas a LED E14 · Lampadine a LED E14 · Becuri cu LED-uri E14 · LED-Valonlähdeet E14 · Żarówki LED E14

Code	Socket	Power	Lumen	Kelvin	Lifetime	Dimmable	Switch Dimmer	Switch Dim To Warm
------	--------	-------	-------	--------	----------	----------	---------------	--------------------

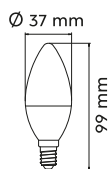

989-40	E14	3,5 W	320 lm	3.000 K	25.000 h			
989-56	E14	4,9 W	400 lm	3.000 K	25.000 h	✓		
989-60	E14	4,9 W	470 lm	3.000 K	15.000 h			
989-66	E14	4,9 W	470 lm	3.000 K	25.000 h		✓	

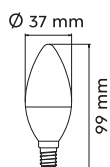

989-509	E14	4,9 W	470 lm	2.200 K	10.000 h			✓
				2.700 K				
				3.000 K				

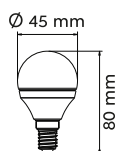

983-40	E14	3,5 W	320 lm	3.000 K	10.000 h			
983-56	E14	4,9 W	470 lm	3.000 K	25.000 h	✓		
983-60	E14	5 W	470 lm	3.000 K	25.000 h			
983-66	E14	4,9 W	470 lm	3.000 K	25.000 h		✓	

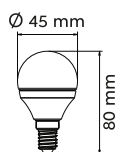

983-509	E14	4,9 W	470 lm	2.200 K	25.000 h			✓
				2.700 K				
				3.000 K				

# LED-LEUCHTMITTEL E14

LED bulbs E14 · Ampoules LED E14 · LED-lampen E14 · Bombillas a LED E14 ·  
Lampadine a LED E14 · Becuri cu LED-uri E14 · LED-Valonlähdeet E14 · Żarówki LED E14

Code	Socket	Power	Lumen	Kelvin	Lifetime	Dimmable	Switch Dimmer	Switch Dim To Warm
------	--------	-------	-------	--------	----------	----------	---------------	--------------------

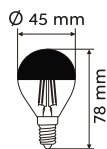

983-410	chrom	E14	4 W	420 lm	2.800 K	10.000 h		
---------	-------	-----	-----	--------	---------	----------	--	--

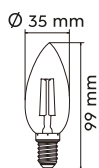

989-400	clear	E14	4 W	470 lm	2.700 K	15.000 h		
989-479	amber	E14	4 W	400 lm	2.700 K	10.000 h		

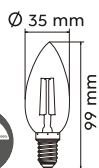

989-4470	clear	E14	4 W	470 lm	2.700 K	15.000 h		✓
989-4790	amber	E14	4 W	400 lm	2.700 K	10.000 h		✓

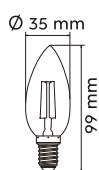

### Set 3

989-3200	clear	E14	2 W	250 lm	2.700 K	10.000 h		
989-3279	amber	E14	2 W	225 lm	2.700 K	10.000 h		

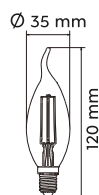

990-279	amber	E14	2 W	225 lm	2.700 K	10.000 h		
990-400	clear	E14	4 W	470 lm	2.700 K	25.000 h		



990-4470	clear	E14	4 W	470 lm	2.700 K	10.000 h		✓
990-4790	amber	E14	4 W	400 lm	2.700 K	10.000 h		✓

Code	Socket	Power	Lumen	Kelvin	Lifetime	Dimmable	Switch Dimmer	Switch Dim To Warm
------	--------	-------	-------	--------	----------	----------	---------------	--------------------



983-400	clear	E14	4 W	470 lm	2.700 K	15.000 h		
983-479	amber	E14	4 W	430 lm	2.700 K	10.000 h		



983-4470	clear	E14	4,5 W	470 lm	2.700 K	25.000 h		✓
983-4790	amber	E14	4 W	400 lm	2.700 K	10.000 h		✓

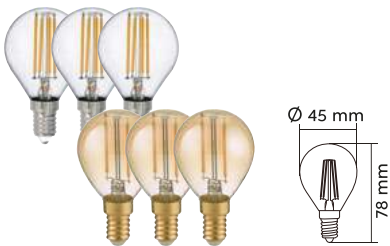

Set 3								
983-3200	clear	E14	2 W	250 lm	2.700 K	10.000 h		
983-3279	amber	E14	2 W	225 lm	2.700 K	10.000 h		

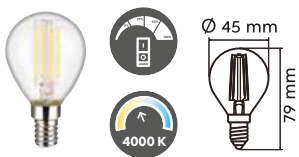

983-440	clear	E14	4 W	500 lm	4.000 K	25.000 h		✓
---------	-------	-----	-----	--------	---------	----------	--	---

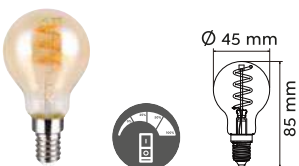

Deko-Filament								
983-4813	amber	E14	4 W	180 lm	1.800 K	25.000 h		✓

# LED-LEUCHTMITTEL GU10

LED bulbs GU10 · Ampoules LED GU10 · LED-lampen GU10 · Bombillas a LED GU10 · Lampadine a LED GU10 · Becuri cu LED-uri GU10 · LED-Valonlähteet GU10 · Żarówki LED GU10

Code	Socket	Power	Lumen	Kelvin	Lifetime	Dimmable	Switch Dimmer	Switch Dim To Warm
------	--------	-------	-------	--------	----------	----------	---------------	--------------------



Set 3

956-330	∠ 110°	GU10	3 W	230 lm	3.000 K	15.000 h		
---------	--------	------	-----	--------	---------	----------	--	--



956-44	∠ 120°	GU10	4,5 W	400 lm	4.000 K	25.000 h	✓	
--------	--------	------	-------	--------	---------	----------	---	--



955-50	∠ 110°	GU10	4,9 W	430 lm	3.000 K	25.000 h		
--------	--------	------	-------	--------	---------	----------	--	--



956-5936	∠ 36°	GU10	4,5 W	345 lm	3.000 K	25.000 h	✓	
----------	-------	------	-------	--------	---------	----------	---	--



956-5736	∠ 36°	GU10	4,5 W	345 lm	3.000 K	25.000 h	✓	
----------	-------	------	-------	--------	---------	----------	---	--



Set 3

956-355	∠ 110°	GU10	4,5 W	345 lm	3.000 K	25.000 h	✓	
---------	--------	------	-------	--------	---------	----------	---	--



956-509	∠ 36°	GU10	4,5 W	345 lm	2.200 K	25.000 h		✓
					2.700 K			
					3.000 K			

# LED-LEUCHTMITTEL G9

LED bulbs G9 · Ampoules LED G9 · LED-lampen G9 · Bombillas a LED G9 · Lampadine a LED G9 · Becuri cu LED-uri G9 · LED-Valonlähteet G9 · Żarówki LED G9

Code	Socket	Power	Lumen	Kelvin	Lifetime	Dimmable	Switch Dimmer	Switch Dim To Warm
------	--------	-------	-------	--------	----------	----------	---------------	--------------------

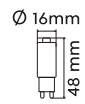

Set 2

929-220	G9	2,3 W	200 lm	3.000 K	25.000 h			
---------	----	-------	--------	---------	----------	--	--	--

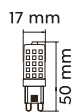

Set 2

929-2300	G9	3 W	300 lm	3.000 K	25.000 h	✓		
----------	----	-----	--------	---------	----------	---	--	--

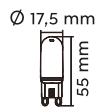

Set 2

929-230	G9	3 W	300 lm	3.000 K	25.000 h		✓	
---------	----	-----	--------	---------	----------	--	---	--

# POS-LÖSUNGEN

POS solutions · Solutions de POS · POS-oplossingen ·  
Soluciones POS · Soluzioni POS · Soluții POS · POS-ratkaisut · Rozwiązania POS

## LME100-240

Tego-Regale · Tego shelves  
Leuchtmittel · light sources

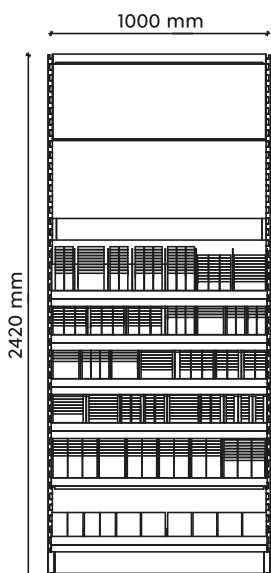
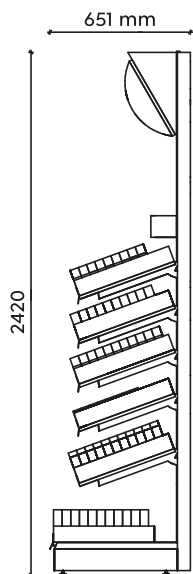



Display **RK51-B**  
Leuchtmittel · light sources

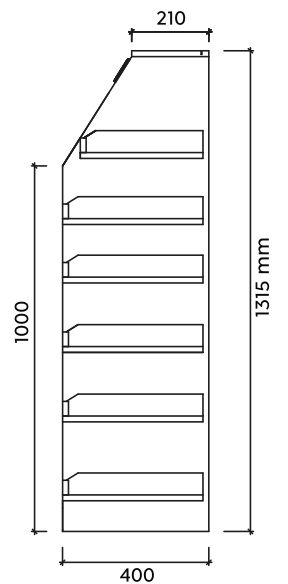
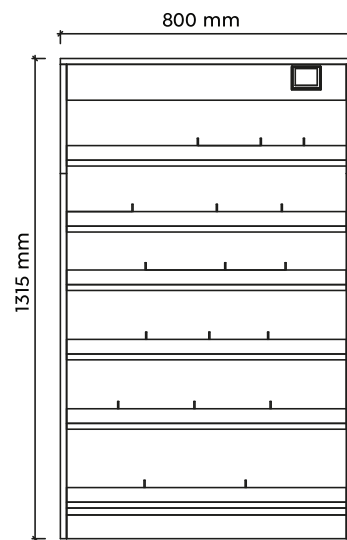

# POS-LÖSUNGEN

POS solutions · Solutions de POS · POS-oplossingen ·  
Soluciones POS · Soluzioni POS · Soluții POS · POS-ratkaisut · Rozwiązania POS



Display **PP011-5141**  
Tischleuchten · Table lamps

Topper TREASURE **PT0094**

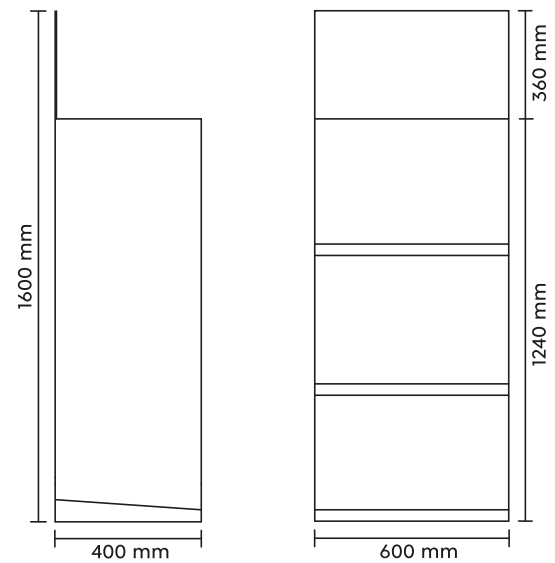

Display **RK75**  
Deckenleuchten · Ceiling lamps

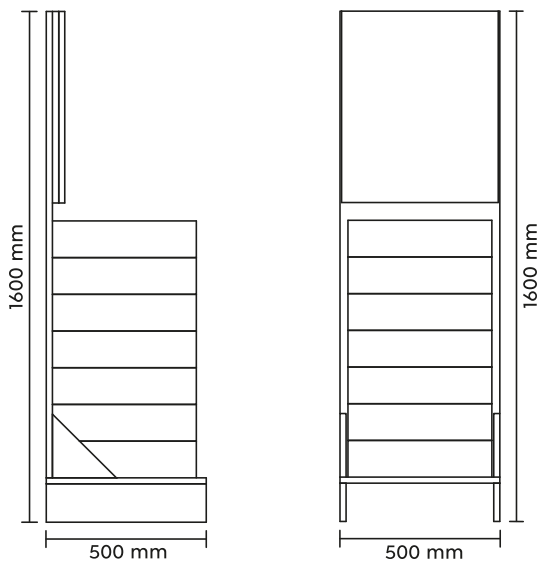





Display **RK106**  
Spots - Spots

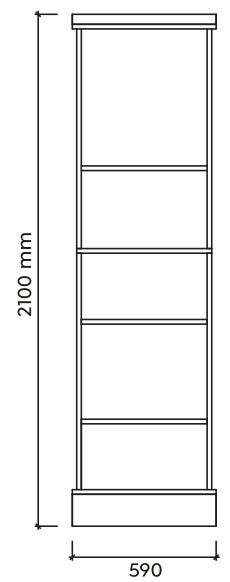
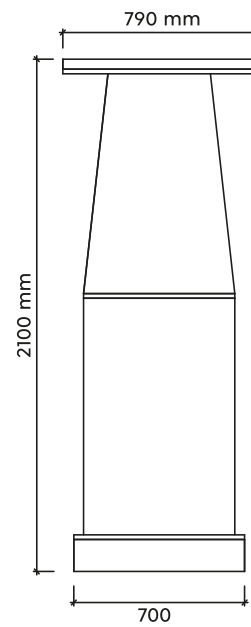

# POS-LÖSUNGEN

POS solutions · Solutions de POS · POS-oplossingen ·  
Soluciones POS · Soluzioni POS · Soluții POS · POS-ratkaisut · Rozwiązania POS

Tego-Regale · Tego shelves  
Schienensystem · track system

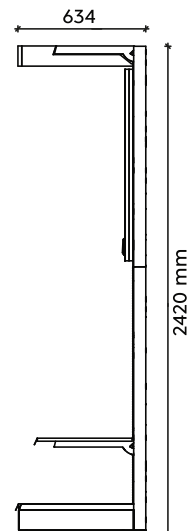
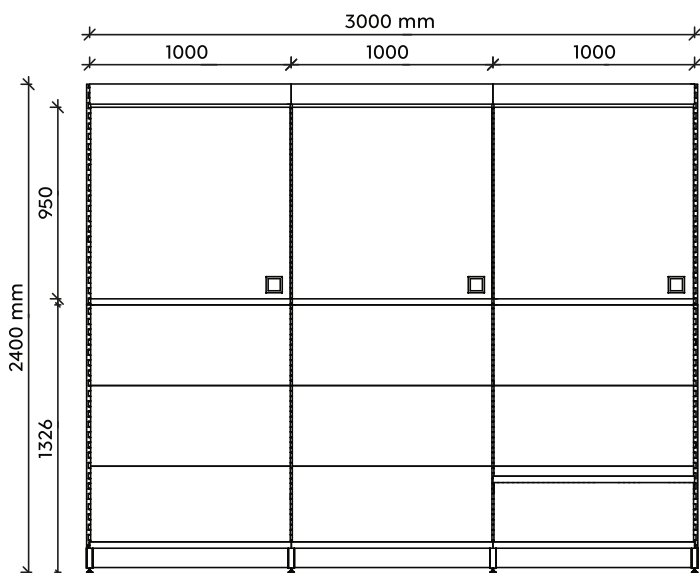

Display **DUO01**  
Schienensystem · track system

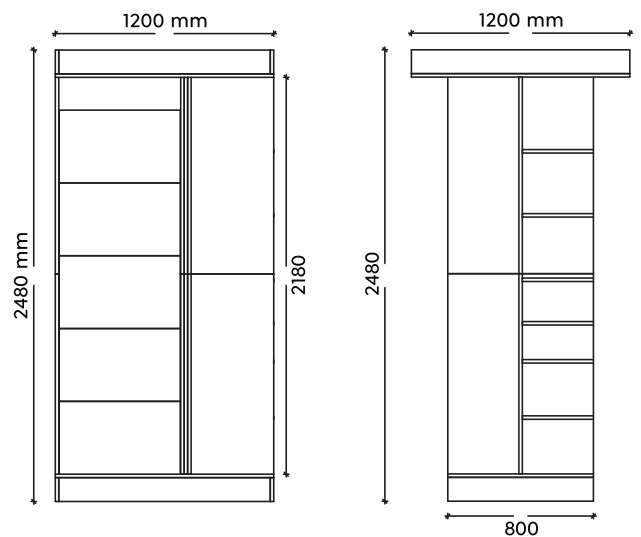

# POS-LÖSUNGEN

POS solutions · Solutions de POS · POS-oplossingen ·  
Soluciones POS · Soluzioni POS · Soluții POS · POS-ratkaisut · Rozwiązania POS

Tego-Regale · Tego shelves  
Einbauleuchten · recessed lights

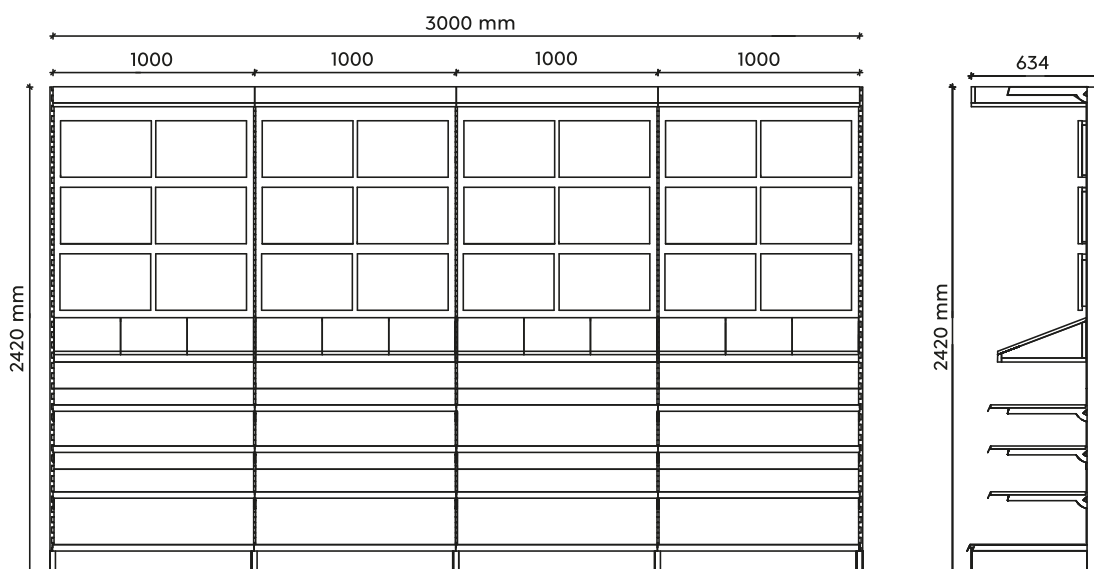
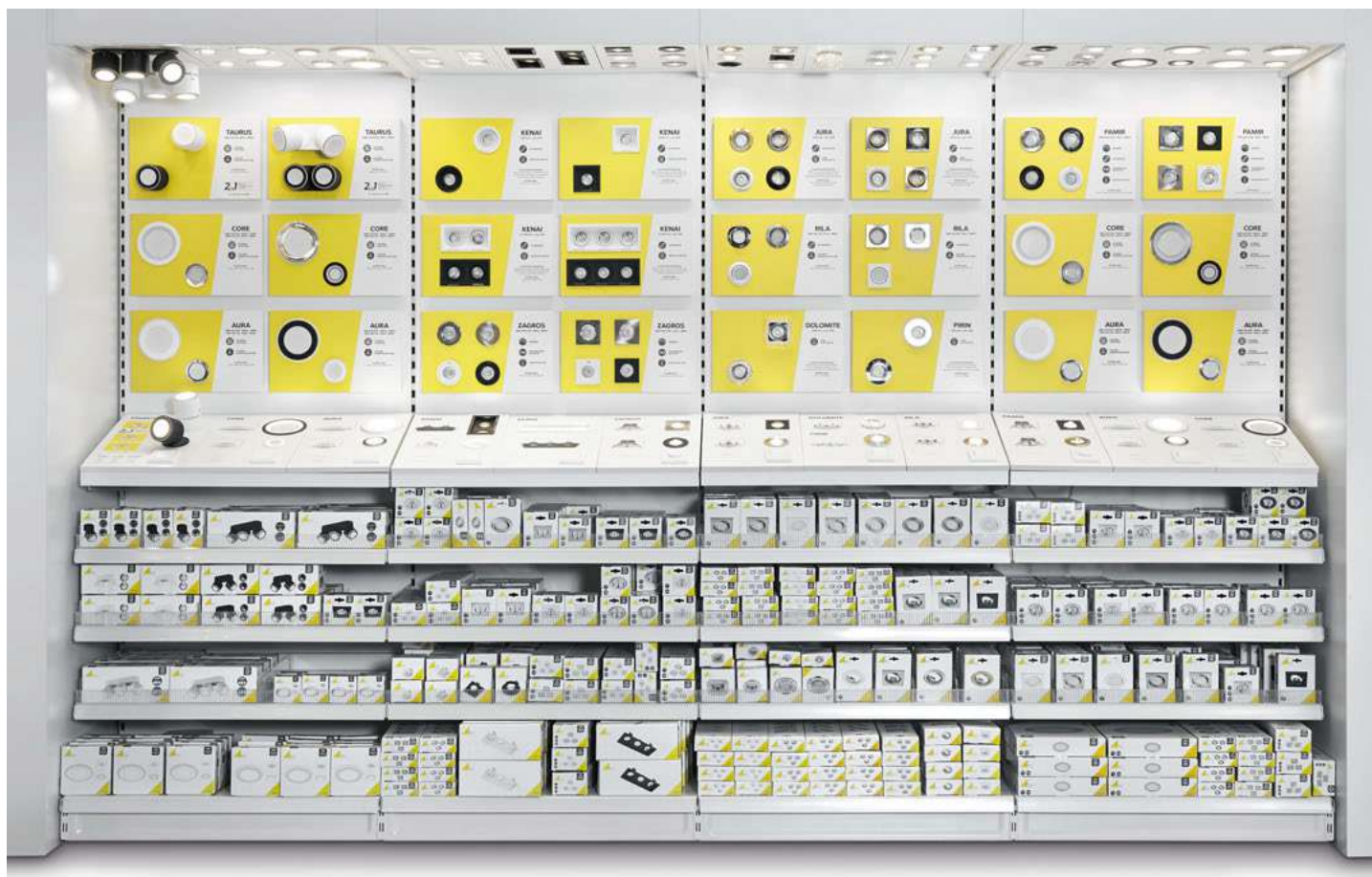

Display **RK63**  
Einbauleuchten · recessed lights

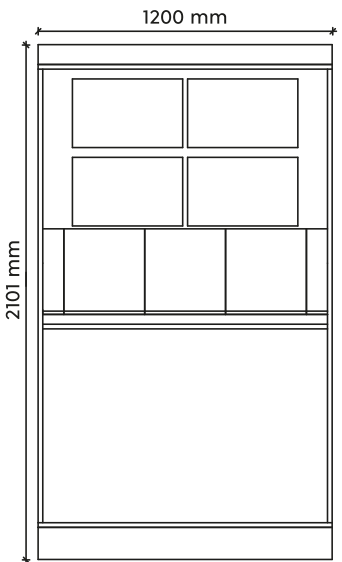
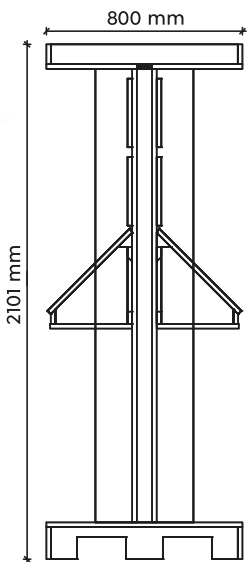

# POS-LÖSUNGEN

POS solutions · Solutions de POS · POS-oplossingen ·  
Soluciones POS · Soluzioni POS · Soluții POS · POS-ratkaisut · Rozwiązania POS

Tego-Regale · Tego shelves  
Badezimmerleuchten · bathroom lighting

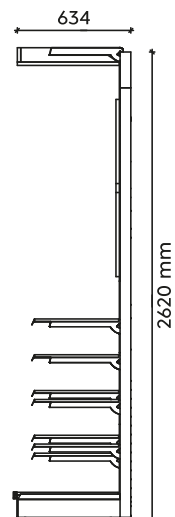
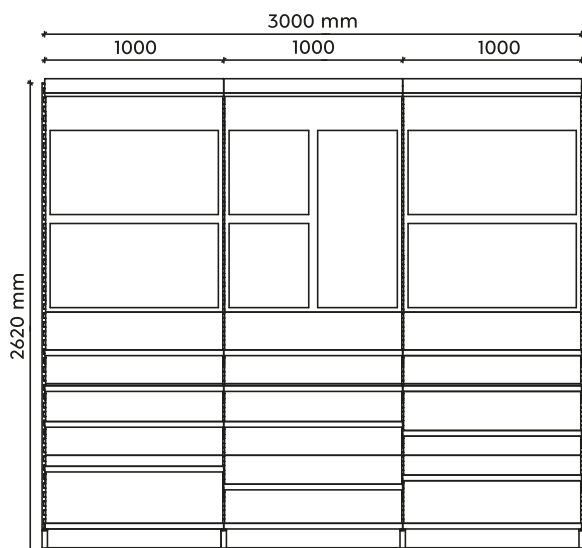

Display **RK99**  
Badezimmerleuchten · bathroom lighting

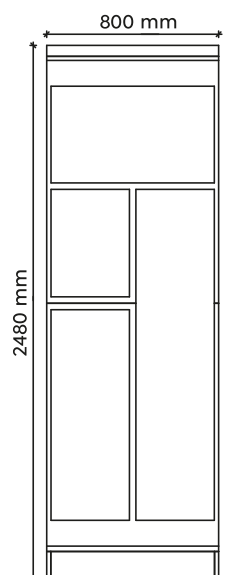
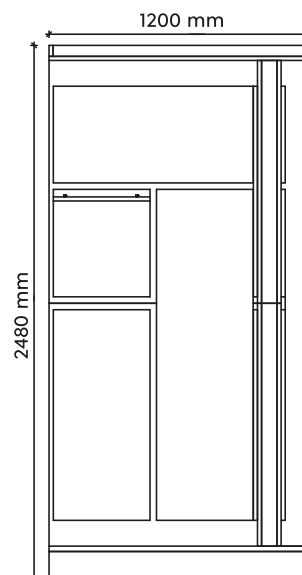

# FARBEN & MATERIALIEN

Colours and materials · Couleurs et matériaux · Kleuren en materialen · Colores y materiales ·  
Colori e materiali · Culori si materiale · Värit ja materiaalit · Kolory i materiały · Renkler ve malzemeler

- 00** Transparent · transparent  
transparent · transparant · transparente · transparente ·  
transparent · kirkas · przezroczysty
- 01** Weiß · white  
blanc · wit · blanco · bianco · alb · valkoinen · biały
- 02** Schwarz · black  
noir · zwart · negro · nero · negru · musta · czarny
- 03** Messing poliert · brass polished  
laiton polis · gepolijst messing · bronze · ottone lucido ·  
bronz · messinki · mosiądz polerowany
- 04** Altmessing · old brass  
laiton fumé · oud brons · bronze viejo · ottone invecchiato ·  
bronz antic · antiikkimessinki · patyna
- 05** Aluminium gebürstet · brushed aluminium  
aluminium balayé · geborsteld aluminium · aluminio pulido ·  
alluminio spazzolato · aluminiu lucios · harjattu alumiini ·  
aluminium szczotkowane
- 06** Chrom · chrome  
chrome · chroom · cromo · cromo · crom ·  
kromi · chrom
- 07** Nickel matt · nickel mat  
nickel mat · nikkel mat · níquel mate · nichel opaco ·  
nichel mat · harjattu teräs · nikiel mat
- 08** Messing matt · brass mat  
laiton mat · messing mat · bronze mate · ottone satinato ·  
bronz mat · mattamessinki · mosiądz mat
- 11** Grau · grey  
gris · grijs · gris · grigio · gri · harmaa · popielaty · gri
- 12** Blau · blue  
bleu · blauw · azul · azzurro · gri · sininen · niebieski
- 13** Amber · amber  
ambre · amber · ámbar · ambra · amber · meripihka ·  
bursztynowy
- 15** Grün · green  
vert · groen · verde · verde · verde · vihreä · zielony
- 17** mehrfarbig · multicolor  
multicolore · multicolor · multicolor · multicolore ·  
multicolor · monivärinen · multi-kolor
- 18** Orange · orange  
orange · oranje · naranja · arancione · portocaliu ·  
oranssi · pomarańczowy
- 19** Türkis · turquoise  
turquoise · turquoise · turquesa · turchese · turcoaz ·  
turkoosi · turkusowy
- 24** rostfarbig · rusty  
rouille · roestkleur · óxido · ruggine · ruginiu · rustiikki ·  
miedź
- 26** Braun · brown  
brun · bruin · marron · marrone · maro · ruskea · brązowy
- 28** rostfarbig antik · antique rust  
rouille antique · roestkleur antiek · oxido · ruggine anticato ·  
ruginiu antic · rustiikki · antyczny rdzawy
- 30** holzfarbig · wood coloured  
couleur bois · houtkleur · color madera · colore di legno ·  
culoare lemn · puunvärinen · kolor drewna
- 31** Weiß matt · white mat  
blanc mat · wit mat · estera blanca · bianco opaco · alb mat ·  
valkoinen matto · biały mat
- 32** Schwarz matt · black mat  
noir mat · mat zwart · estera negra · nero opaco ·  
negru mat · musta matto · czarny mat
- 34** Schwarz-Weiß · black and white  
noir et blanc · zwart en wit · blanco y negro ·  
nero e bianco · negru și alb · mustavalkoinen ·  
biały i czarny
- 36** naturbelassen · natural finish  
finition naturelle · natuurlijke afwerking · acabado natural ·  
finitura naturale · finisaj natural · luonnollinen viimeistely ·  
naturalne wykończenie
- 41** Taupe · taupe  
taupe · taupe · gris pardo · taupe · taupe ·  
ruskeanharmaa · ciemnoszary
- 42** Anthrazit · anthracite  
antracite · antraciet · antracita · antracite · antracit ·  
antrasiitti · antracyt
- 44** Beige · fawn  
beige · beige · beige · beige · bej · beige · beż
- 49** Pistaziengrün · pistachio green  
vert pistache · pistachegroen · verde pistacho ·  
verde pistacchio · verde fistic · pistaasin vihreä ·  
zielony pistacjowy
- 52** Transparent klar · transparent clear  
transparent claire · transparant helder · transparente claro ·  
transparente chiaro · transparent clar · kirkas · przezroczysty
- 54** rauchfarbig · smoke  
fumé · rookkleur · humo · fume' · fumuriu ·  
savu · przydymiony
- 57** Chrom bedampft · chrome plated  
chromé · verchroomd · acero cromado · cromato ·  
cromat · kromattu · chromowany
- 62** Kupfer antik · antique copper  
cuivre ancien · antiek koper · cobre antiguo · rame antico ·  
cupru antic · antiikki kupari · antyczne miedzi
- 65** Coffee · coffee  
café · koffie · café · caffè · cafea · antiikkiteräs · kawa



- 66** Sand · sand  
Zand · Arena · Sabbia · Nisip · Hiekka ·  
Piaskowy · Kum
- 67** Nickel antik · nickel antique  
nickel antique · antiek nikkel · níquel antiguo · nickel anticato ·  
nichel antic · antiikkiteräs · aikiel antyczny
- 76** Warm Grau · Warm Grey  
Gris chaud · Warm grijs · Gris cálido · Grigio caldo · Gri cold ·  
Lämmin harmaa · Ciepły szary
- 77** Ultimate Grau · ultimate grey  
gris ultimate · ulziem grijs · gris absoluto · grigio assoluto ·  
gri suprem · kultaa · ciemnoszary

- 79** goldfarbig · gold  
or · goud · oro · oro · aur · kultaa · złota
- 80** Schwarz-Gold · black-gold  
noir et or · zwart-goud · negro-oro · oro nero ·  
negru-auriu · musta-kulta · czarno złoty
- 83** Illuminate Gelb · illuminate yellow  
jaune illuminate · helder geel · amarillo iluminado ·  
giallo brillante · galben strălucitor · titaani · świetlisty złoty
- 87** titanfarbig · titan  
titane · titaan · titán · titano · titaniu ·  
titaani · tytanowy

-  **D Schutzklasse 1**  
Leuchten für den Anschluss an den netzseitigen Schutzleiter. Das Symbol ist an der Anschlussstelle angebracht.
- GB Protection grade I:**  
Lamps for connection to network safety conductors. The symbol is placed at the connection port.
- FR Degré de protection I:**  
Les lampes qui ont une connexion avec la prise de terre. Les lampes qui ont une connexion avec la prise de terre.
- NL Beschermklasse I:**  
Lampen voor aansluiting op de netzijdige veiligheidsaarddraad. Het symbool is op het aansluitpunt aangebracht.
- ES Protección tipo I:**  
Lámparas para conectar en redes de conductores seguros. El símbolo está indicado en el conector.
- IT Classe di protezione I:**  
Apparecchi con parti metalliche costantemente collegate al circuito di terra. Il simbolo è riportato sul punto di collegamento.
- RO Protectie grad I:**  
Lampile care au conectare cu priza de pamant. Simbolul este plasat la punctul de conectare.
- FI Suojausluokka I:**  
Valaisimet, jotka liitetään verkon turvamaadoitukseen. Symboli on merkitty liitäntäkohtaan.
- PL Klasa ochrony I:**  
Oprawy przystosowane do podłączenia przewodu ochronnego. Oznakowanie znajduje się w miejscu podłączenia.

-  **D Schutzklasse 2**  
Leuchten für den Betrieb mit Schutzkleinspannung.
- GB Protection grade II:**  
Protected low voltage lamps.
- FR Degré de protection II:**  
Les lampes protégées à faible voltage.
- NL Beschermklasse II:**  
Lampen voor het gebruik met veiligheidslaagspanning.
- ES Protección tipo II:**  
Lámparas de bajo voltaje con protección.
- IT Classe di protezione II:**  
Apparecchi alimentati con tensione di sicurezza inferiore ai 50 V.
- RO Protectie grad II:**  
Lampi protejate la tensiune joasa.
- FI Suojausluokka II:**  
Valaisimet, joita käytetään suojapienjännitteellä.
- PL Klasa ochrony II:**  
Oprawy przeznaczone do zasilania z sieci o niskim napięciu bezpiecznym.

# PRODUKTEIGENSCHAFTEN

Features · Caractéristiques · Kenmerken · Acabados ·  
Caratteristiche · Caracteristici · Ominaisuudet · Cechy



## Schalter · Switch

Interrupteur · Schakelaar · Interruptor ·  
Interruttore · Intrerupator · Kytkin ·  
Przełącznik



## Fußschalter · Footswitch

interrupteur à pédale · Voetschakelaar ·  
Interruptor de pie · interruttore a pedale ·  
comutator picior · Päälle / pois jalkakytin ·  
wyłącznik nożny



## Schnurschalter · Cable switch

Interrupteur de cordon · Snoerschakelaar ·  
Cable de interruptor · Interruttore su cavo ·  
Intrerupator cu cablu · katkaisin ja johto ·  
Przełącznik na kablu



## On/Off Touch Funktion · On/Off Touch function

Interrupteur tactile On/Off · Touch schakelaar On/Off ·  
Función táctil On/Off · Interruttore touch On/Off ·  
Intrerupator tactil On/Off · Kosketuskäyttöinen On/Off ·  
Funkcja dotykowa On/Off



## Getrennt schaltbar · Separately switchable

Interrupteurs séparés · Gescheiden schakelbaar ·  
Interruptores separados · Interruttori separati ·  
Intrerupatoare separate · Erikseen kytkettävissä ·  
Oddzileny przełącznik



## Fernbedienung · Remote control

Commande à distance · Afstandsbediening ·  
Mando a distancia · Comando a distanza ·  
Telecomanda · Kauko-ohjain · Pilot



## Integrierter Dimmer · Integrated dimmer

Variateur intégré · Geïntegreerde dimmer ·  
Regulador integrado · Dimmer integrato ·  
Variator de lumina integrat · Integroitu himmennin ·  
Wbudowany ściemniacz



## Zugschalter · Pull switch

Interrupteur de trait · Trekschakelaar ·  
Interruptor de tiro · Interruttore con tirata ·  
Interupator de tragere · Vetokytkin ·  
Przełącznik pociągany



## Sensordimmer · Sensor dimmer

Variateur tactile · Touchdimmer ·  
Regulador con sensor · Touchdimmer ·  
Variator cu senzor · Kosketushimmennin ·  
Czujnik ściemniania



## Extern dimmbar · Externally dimmable

Dimmable avec variateur externe · Extern dimbaar ·  
Dimmable por regulador externo · Dimmerabile con  
dimmer esterno · variator extern de lumina ·  
himmennettävissä · Zewnętrznie ściemniania



## RGB Farbwechsler · RGB Colorchanging

Changeement de couleur RGB · RGB Kleurverandering ·  
Cambio de color RGB · Cambia colore RGB ·  
Schimbator de culoare RGB · Värinvaihto RGB ·  
Zmieniający kolor RGB



## RGBW Farbwechsler · RGBW Colorchanging

Changeement de couleur RGBW · RGBW Kleurverandering ·  
Cambio de color RGBW · Cambia colore RGBW ·  
Schimbator de culoare RGBW · Värinvaihto RGB ·  
Zmieniający kolor RGBW



## Lichtfarbe einstellbar · Adjustable light color

Couleur de lumière réglable · Lichtkleur instelbaar ·  
Color de luz regulable · Colore della luce regolabile ·  
Lumina colorata reglabila · Värilämpötila säädettävissä ·  
Regulowana barwa światła



## Lichtfarbe stufenlos einstellbar ·

## Light color infinitely variable

Couleur de lumière infiniment variable · Lichtkleur  
traploos instelbaar · Color de luz infinitamente variable ·  
Colore della luce infinitamente variabile · Culoare lumină  
infiniit variabilă · Valon väri portaattomasti · Jasny kolor  
beztopniowo



## DIP SWITCH

## Lichtfarben direkt an der Leuchte einstellbar ·

## Colours directly adjustable at the lamp

Les couleurs de la lumière peuvent être réglées  
directement sur le luminaire · Lichtkleuren direct  
instelbaar op de lamp · Tonalidades de luz ajustables  
directamente en la lámpara · Colori della luce regolabili  
direttamente sulla lampada · Colori ale luminii reglabile  
direct de la bec · Valon väri asetettävissa suoraan  
valaisimesta · Barwy światła można ustawić bezpośrednio  
na oprawie



## ColorSwitch (Lichtfarbe einstellbar mit Schalter) ·

## Light color adjustable with switch

Couleur de lumière réglable avec interrupteur · Lichtkleur  
instelbaar met schakelaar · Color de la luz ajustable con  
interruptor · Colore della luce regolabile con interruttore ·  
Culoarea luminii reglabilă cu un comutator · Valon väri  
säädettävällä kytkimellä · Kolor światła regulowany  
przełącznikiem



## Höhenverstellbar · Adjustable height

Hauteur réglable · In hoogte verstelbaar ·  
Altezza regolabile · Altezza regolabile ·  
Inaltime reglabila · Säädettävä korkeus ·  
Regulowana wysokość



## Ausziehbar · Extendible

extensible · Verlengbaar · Extensible ·  
Estensibile · extensibila · Jatkettava ·  
Rozsuwalny



### LIFT ME

Innovative Höhenverstellung ohne Gegengewicht · Innovative height adjustment without counterweight · Nouveau! Réglage de la hauteur sans contrepoids · Innovatieve hoogteverstelling zonder contragewicht · Innovador sistema de ajuste de altura sin necesidad de contrapeso · Regolazione innovativa dell'altezza senza contrappeso · Ajustare inovativa a inaltimii fara contragreutate · Innovatiivinen korkeuden säätö ilman vastapainoa · Innowacyjna regulacja wysokości bez przeciwwagi



### Schwenkbar · Slewable

Pivotant · Draaibaar · Pivotante · Girevole · Pivotant · Suunnattava · Skråtøy



### Steckdose · Plug

Prise · Stekker · Enchufe · Spina · Priza · Katkaisin · Gniazdko



### Vergrößerung 3x · Magnification 3x

Magnification 3x · Vergroting 3x · Aumentos 3x · Ingrandimento 3x · Suplimentare 3x · Suurentava 3x · Powiększenie 3x



### 4 fach TOUCH · 4 level Touch function

Interrupteur tactile 4 niveaux · Touch schakelaar 4 niveaus · Función Táctil 4 nivel · Interruttore touch 4 livelli · Intrerupator tactil 4 nivele · Kosketuskäyttöinen 4 taso · Funkcja dotykowa 4 poziomy



### Flexibel · Flexible

Flexible · Flexibel · Flexible · Flessibile · Flexibil · Joustava · Elastyczne



### Kippbar · Tilttable

Inclinable · Kantelbaar · Basculante · Inclinabile · Basculant · Kallistettava · Uchylny



### USB Anschluss mit Ladefunktion · Recharging USB connection

Entrée USB de rechargement · Opladende USB aansluiting · Conexión USB de recarga · Connessione USB di ricarica · Conexiune USB reîncărcare · Lataaminen USB-liitäntä · ładowania USB połączenie



### USB-C Anschluss mit Ladefunktion · Recharging USB-C connection

Entrée USB-C de rechargement · Opladende USB-C-poort · Conexión USB-C de recarga · Connessione USB-C di ricarica · Conexiune USB-C de reîncărcare · Lataaminen USB-C-liitäntällä · złącze USB-C z funkcją ładowania



### Nachtlicht · Night light

Veilleuse de nuit · Nachtlicht · Luz de la noche · Luce notturna · Lampă de noapte · Yyövalo · Lampka nocna



### Sleep-Timer · Sleep timer

Compte-minutes de sommeil · Slaaptimer · Temporizador de sueño · Timer di spegnimento · Sleep timer · Uniajastin · Wyłącznik czasowy



### Up and down Beleuchtung · Up and Down lighting

Point lumineux en haut et en bas · Lichtpunt boven en onder · Luz de arriba y abajo · Luce su e giù · Sus și în jos lumina · Ylös ja alas valoa · W górę iw dół światło



### Dimmbar mit Schalter · Dimmable via switch

Réglable avec interrupteur · Dimbaar via schakelaar · Regulable mediante interruptor · Dimmerabile tramite interruttore · Estompat prin comutator · Himmennettävä kytkimen · Ściemnialne za pośrednictwem przełącznika



### Musterschutz · Registered model

Modèle déposé · Beschermtd model · Modelo certificado · Modello depositato · Înregistrați model · Rekisteröity malli · Zarejestrowany wzór



### Starlight Effekt · Starlight effect

Effet étoiles · Starlight effekt · Efecto estrella · Effetto stelle · Efect de "stele" · Tähti efekti · Effekt starlight



### Ohne Leuchtmittel · Lamp(s) excluded

Sans ampoule(s) · Zonder lichtbron(nen) · Sin bombilla(s) · Lampadina Esclusa · Fara bec (s) · Ilman polttimo (s) · Bez żarówki (s)



### Memory Funktion · Memory function

fonction mémoire · Geheugen functie · Función de memoria · Funzione memorizzazione · functia memorie · Muistitoiminto · Funkcja pamięci



### indirekte Beleuchtung · indirect lighting

lumière indirecte · indirecte belichting · Iluminación indirecta · Illuminazione a scomparsa · iluminat indirect · epäsuora valaistus · oświetlenie pośrednie



### Induktive Ladestation · Inductive loading station

Station de chargement inductif · Inductief laadstation · Estación de carga inductiva · Stazione di carico induttivo · Stație de încărcare inductivă · Induktiivinen latausasema · Stacja ładowania indukcyjnego

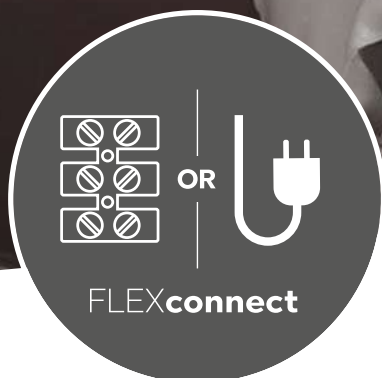

inkl. Zuleitung · incl. cable

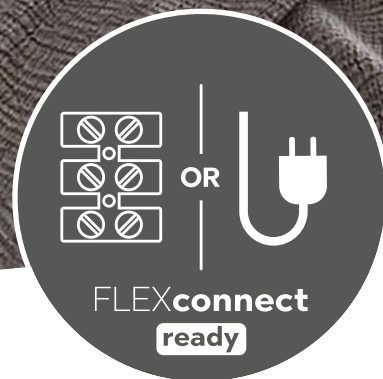

exkl. Zuleitung · excl. cable

Ⓓ

Diese Wandleuchte ist sowohl für den Festanschluss, als auch für den Betrieb mit Steckerzuleitung geeignet.

Ⓐ

Deze wandlamp is zowel geschikt voor een vaste stroomaansluiting als voor het aansluiten van een plug-in voedingskabel.

Ⓜ

Aceasta aplica este potrivita atat pentru a fi montata direct la sursa de curent, dar si pentru a fi conectata printr-un cablu de curent la priza.

Ⓖ

This wall light is suitable both for a fixed power connection, as well as for the connection of a plug-in power cable.

Ⓔ

Esta luz de pared es adecuada tanto para una conexión de alimentación fija como para la conexión por cable de alimentación.

Ⓕ

Tämä seinävalaisin voidaan asentaa kiinteästi kytkentärیمان avulla tai käyttämällä mukana tulevaa liitosjohtoa.

Ⓕ

Cette applique convient à la fois pour une connexion d'alimentation fixe, ainsi que pour la connexion d'un câble d'alimentation enfichable.

Ⓙ

Questa lampada da parete è adatta sia per una connessione di alimentazione fissa, sia per la connessione di un cavo di alimentazione plug-in.

Ⓟ

Ta lampa ścienna jest odpowiednia zarówno do podłączenia na stałe, jak również do eksploatacji przy użyciu przewodu z wtyczką.

## DIP SWITCH

Mittels DIP SWITCH können 3 Lichtfarben (warmweiß, neutralweiß und kaltweiß) über einen Schalter direkt an der Leuchte eingestellt werden.

The DIP SWITCH directly sets the luminaire's three light colours (warm, neutral and cool white).



**Warmweiß** | Warm white



**Neutralweiß** | Neutral white



**Kaltweiß** | Cool white

## LED SWITCH DIMMER

DIMMEN OHNE DIMMER | DIMMING WITHOUT DIMMER

Helligkeit bequem mit jedem herkömmlichen Lichtschalter einstellbar.

Adjusting the desired level of brightness with any conventional light switch.



100%

on  
1x  
off

**Licht einschalten**  
Switch on the light

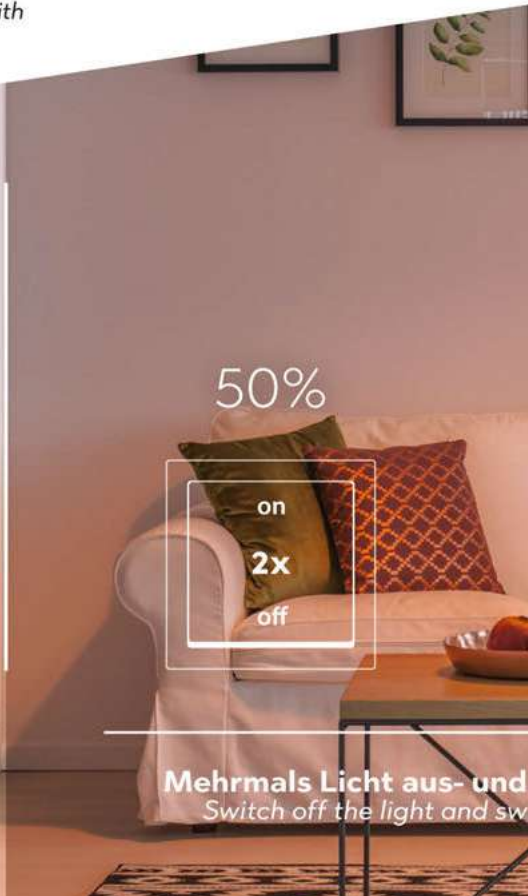

50%

on  
2x  
off

**Mehrmals Licht aus- und sofort wieder einschalten**  
Switch off the light and switch it immediately on again

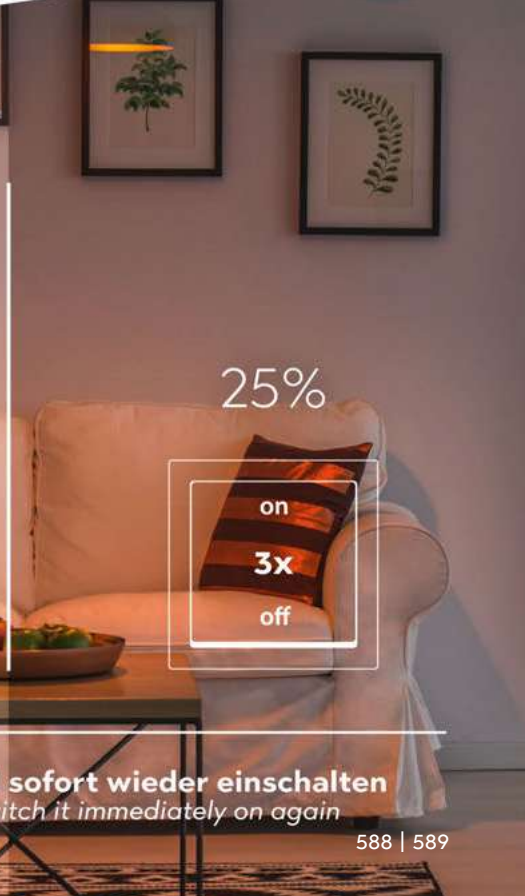

25%

on  
3x  
off



### Mehrere Standorte

Kontrollieren und Steuern von mehreren Standorten gleichzeitig und von überall aus. Ob das eigene Zuhause oder die Ferienwohnung.

### Multiple locations

Control and command multiple locations simultaneously and from anywhere. Whether your own home or your holiday home.

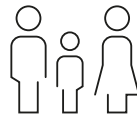

### Mehrere Nutzer

Die Anzahl der Nutzer zur Steuerung der Leuchten kann individuell festgelegt werden.

### Multiple user

The number of persons to control the lights can be set individually.



### Cloud basiert

WiZ verbindet sich mit der Cloud, damit Vorlieben gespeichert, Wünsche geteilt und Updates automatisch generiert werden.

### Cloud based

WiZ connects to the cloud to store preferences, share desires and generate updates automatically.



### Keine zusätzliche Bridge erforderlich

Es wird keine zusätzliche Bridge oder Hub für die Steuerung der Leuchten benötigt.

### No additional hub needed

There is no need for an additional bridge or hub to control the lights.



### Mehrere Räume

Alle Leuchten können unterschiedlichen Räumen zugeordnet und präzise gesteuert werden – einzeln oder in Gruppen.

### Several rooms

All lights can be assigned to different rooms and precisely controlled – individually or in groups.



### Wlan Technologie

WiZ nutzt Wlan-Technologie als sichere, unabhängige, kostengünstige und einfach zu installierende Funklösung.

### WiFi technology

WiZ uses Wi-Fi technology as a secure, independent, affordable and easy-to-install wireless solution.

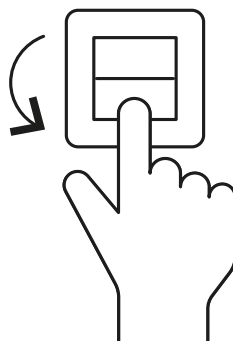

### WiZ

#### CLICK

Einfach und effektiv. Zwei bevorzugte Lichtmodi können über den vorhandenen Lichtschalter bedient werden.

Simple and effective. Two preferred light modes can be operated via the existing light switch.



## WiZ APP

Einfach und schnell installiert. Volle Funktionalität und Flexibilität mit der WiZ App – erhältlich im App Store oder bei Google Play.

Easy and quick to install. Full functionality and flexibility with the WiZ App – available on the App Store or on Google Play.



## WiZ MOTE

Steuerung über die Fernbedienung und Abspeichern von vier favorisierten Lichtmodi möglich.

Control via the remote control and possibility to save four favorite light modes.



[trio-lighting.com/wiz](http://trio-lighting.com/wiz)



## WiZ MAGIC

Steuerung der Leuchten über Zeitpläne, Sensoren oder einfache Sprachbefehle. Kompatibel mit Amazon Alexa und Google Home.

Control of the lights by time schedules, with sensors or by simple verbal commands. Compatible with Amazon Alexa and Google Home.

## DIMMEN DIMMING



64.000 **WEISSTÖNE**  
64,000 **WHITES**

Einstellbare Lichtprogramme · Preset light modes



16 Millionen **FARBEN**  
16 million **COLORS**

Dynamische Lichtprogramme · Dynamic light modes



**30** Sekunden zur Installation · **30** seconds to install



Die Lampe installieren  
Install a lamp



Wählen Sie den „Koppeln“ Modus  
Start pairing



3 x EIN / AUS  
3 x ON/OFF



Die Lampe beginnt „blau“ zu blinken und schaltet danach auf weiß  
Light turns blue then goes white



Die Einstellungen sind nun gespeichert, jeder kann zu Hause WiZ nutzen.  
The settings are now saved!  
Now everyone can use WiZ at your home.

# GET YOUR LIGHT CONNECTED.

FR NL ES IT RO FI PL

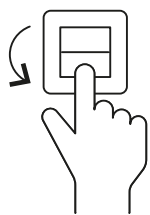

## WiZ CLICK

Simple et efficace. Deux modes d'éclairage préférés peuvent être commandés via l'interrupteur d'éclairage existant.

Eenvoudig en effectief. Twee voorkeurstellingen kunnen worden bediend via de bestaande lichtschakelaar.

Helppoa ja tehokasta. Kaksi toivottua valo asetusta jota voidaan käyttää seinäkytkimellä.

Simplu si efectiv. Pot fi operate 2 moduri de iluminat preferate prin comutatorul de lumina existent.

Semplice ed efficace. È possibile utilizzare due modalità di illuminazione preferite tramite l'interruttore della luce esistente.

Simple y efectivo. Dos ambientes de luz preferidos pueden operar a través del interruptor convencional.

Proste i efektywne. Dwa preferowane tryby oświetlenia można obsługiwać za pomocą dostępnego przełącznika oświetlenia.

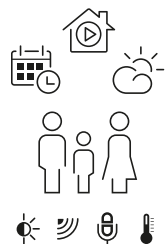

## WiZ MAGIC

Contrôle des lumières par programme horaire, par capteurs ou par simples commandes vocales. Compatible avec Amazon Alexa et Google Home.

Aansturing van de lampen met tijdschema's, door sensoren of via eenvoudige spraakopdrachten. Compatibel met Amazon Alexa en Google Home.

Valoja voi säätää aikataulutetusti, sensoreilla tai yksinkertaisilla ääni komennoilla. Yhteensopiva Amazon Alexan ja Google Homen kanssa.

Controlul luminilor prin programarea orei/timpului, cu senzori sau printr-o simpla comanda verbala. Compatibil cu Amazon Alexa si Google Home.

Controllo delle luci secondo gli orari, con sensori o semplici comandi verbali. Compatibile con Amazon Alexa e Google Home.

Control de las luces con horarios, con sensores o por simples comandos de voz. Compatible con Alexa de Amazon y Google Home.

Ustawianie i sterowanie lampami za pomocą harmonogramów.



## WiZ APP

Installation facile et rapide. Toutes les fonctionnalités et flexibilité disponible avec l'application WiZ, téléchargeable sur App Store ou Google Play.

Eenvoudig en snel te installeren. Volledige functionaliteit en flexibilititeit met de WiZ-app - beschikbaar in de App Store of op Google Play.

Helppo ja nopea asentaa. Käyttö WiZ-aplikaatiolla - saatavissa App Storesta tai Google Play kaupasta.

Instalare usoara si rapida. Functionalitate completa si flexibilitate cu WIZ App - disponibil pe App store sau pe Google Play.

Facile e veloce da installare. Piena funzionalità e flessibilità con l'App Wiz disponibile su App Store e su Google Play.

Fácil y rápido de instalar. Amplia funcionalidad y flexibilidad con la aplicación WiZ, disponible en la App Store o en Google Play.

Prosta i szybka instalacja. Pełna funkcjonalność i elastyczność dzięki aplikacji WiZ - dostępnej w App Store lub Google Play.



## WiZ MOTE

Contrôle via la télécommande et possibilité de sauvegarder quatre modes d'éclairage favoris.

Aansturen via de afstandsbediening en mogelijkheid om vier favoriete licht instellingen te bewaren.

Toimintojen säätö kaukosäätimellä ja mahdollisuus tallentaa neljä valo asetusta.

Controlul prin telecomanda si posibilitatea de a memora/salva 4 moduri favorite.

Controllo tramite telecomando e possibilità di salvare quattro modalità luce preferite.

Control via mando a distanza y con posibilidad de guardar 4 ambientes favoritos.

Możliwość sterowania za pomocą pilota i zapisywania czterech preferowanych trybów oświetlenia.



### Résidences multiples

Contrôlez et commandez plusieurs résidences simultanément et de n'importe où. Que ce soit votre propre maison ou votre deuxième résidence.

### Meerdere locaties

Controleren en aansturen van meerdere locaties tegelijkertijd en van overal. Uw thuis of uw vakantiehuis.

### Useita sijainteja

Voit hallita useita sijainteja, kotiasi tai kesäasuntoasi samanaikaisesti.

### Locatii Multiple

Control si comanda a locatiilor multiple simultan si de oriunde. Fie ca te afli acasa sau in casa de vacanta

### Molteplici Location

Controlla e comanda più sedi contemporaneamente e da qualsiasi luogo. Che tu sia casa tua o la tua casa vacanza.

### Múltiples localizaciones

Control y cambio en múltiples localizaciones simultáneamente, tanto tu casa como en tu segunda residencia.

### Kilka lokalizacji

Kontrola i sterowanie z kilku lokalizacji jednocześnie i zewsząd. Czy to z własnego domu, czy też z wakacyjnego mieszkania.



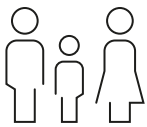

### Multiplés utilisateurs

Le nombre de personnes pour contrôler les lumières peut être déterminé individuellement.

### Meerdere gebruikers

Het aantal personen dat de lampen aanstuurt, kan individueel worden ingesteld.

### Monta eri käyttäjää

WiZ käyttäjien määrä voidaan yksilöllisesti määrittää.

### Utilizatori multipli

Numarul de persoane care sa controleze luminile poate fi setat individual.

### Molteplici Utenti

Il numero di persone per controllare le luci può essere impostato individualmente.

### Múltiples usuarios

El número de personas que controlan las luces se puede configurar individualmente.

### Kilku użytkowników

Liczba użytkowników mogących sterować lampami może być określana indywidualnie.



### Basé sur le cloud

WiZ se connecte au cloud pour stocker les préférences, partager les désirs et générer automatiquement des mises à jour.

### Cloud gebaseerd

WiZ maakt verbinding met de cloud om voorkeuren op te slaan, wensen te delen en automatische updates te genereren.

### Pilvipalveluun perustuva

WiZ ottaa yhteyden pilvipalveluun, tallentaa asetukset ja luo päivitykset automaattisesti.

### Pe baza de Cloud

WiZ te conectează la Cloud la magazinul preferat, transmite dorințele și generează update-uri în mod automat.

### Basato sul Cloud

WiZ si connette al cloud per memorizzare le preferenze, condividere desideri e generare automaticamente gli aggiornamenti.

### Basado en la nube

WiZ conecta con la nube para guardar tus preferencias, comparte y genera actualizaciones automáticamente.

### Oparte na chmurze

WiZ łączy się z chmurą, aby zapisywać preferencje, rozdzielać życzenia i automatycznie generować aktualizacje.



### Lieux multiples

Toutes les lumières peuvent être assignées à différentes pièces et contrôlées avec précision - individuellement ou en groupe.

### Meerder woonruimtes

Alle lampen kunnen worden toegewezen aan verschillende woonruimtes en nauwkeurig worden aangestuurd - individueel of in groepen.

### Useita huoneita

Jokainen valo voidaan määrittää eri huoneelle. Hallittavissa ryhmissä tai yksittäin.

### Câteva camere

Toate luminile pot fi atribuite mai multor camere diferite și pot fi controlate cu precizie -individual și în grupuri.

### Numerose stanze

Tutte le luci possono essere assegnate a stanze diverse e controllate con precisione - individualmente o in gruppi.

### Varias habitaciones

Todas las luces pueden ser asignadas a diferentes habitaciones y controladas con precisión - individualmente o en grupo.

### Kilka pomieszczeń

Wszystkie lampy mogą być przyporządkowywane do różnych pomieszczeń i precyzyjnie sterowane – pojedynczo lub w grupach.



### Pas besoin de pont

Il n'y a pas besoin d'un dispositif supplémentaire pour contrôler les lumières.

### Geen hub nodig

Er is geen extra apparaat nodig om de lampen aan te sturen.

### Ei tarvetta erilliselle keskukselle

Ei tarvetta erilliselle keskukselle valojen säätämiseen.

### Nu e nevoie de nici un punct central

Nu e nevoie de o punte sau hub pentru a controla luminile.

### Non sono necessari altri hub

Non è necessario un ponte o un hub aggiuntivo per controllare le luci.

### No necesaria una unidad central

No es necesario una conexión adicional o unidad central para controlar las luces.

### Bez konieczności stosowania dodatkowych mostków

Do sterowania lampami nie jest potrzebny żaden dodatkowy mostek.



### Technologie WiFi

WiZ utilise la technologie WiFi comme une solution sans fil sécurisée, indépendante, abordable et facile à installer.

### WiFi-technologie

WiZ gebruikt Wi-Fi-technologie als een veilige, onafhankelijke, betaalbare en eenvoudig te installeren draadloze oplossing.

### WiFi teknologia

WiZ käyttää Wi-Fi teknologiaa turvallisena, itsenäisenä, edullisena ja helppo käyttöisenä langattomana ratkaisuna.

### Technologie WiFi

WiZ folosește tehnologia Wi-Fi ca o soluție de internet sigură, independentă, permisivă și ușor de instalat.

### Tecnologia Wi-Fi

WiZ utilizza la tecnologia Wi-Fi come soluzione wireless sicura, indipendente, economica e facile da installare.

### Tecnología WiFi

WiZ utiliza la tecnología Wi-Fi como una solución inalámbrica segura, independiente, asequible y fácil de instalar.

### Technologia WLAN

WiZ używa technologii „WLAN” jako bezpiecznego, niezależnego, niskonakładowego i łatwego w instalacji rozwiązania radiowego.

# DUOLINE

Système de voie à deux phases (230 V) · 2-fase-spoorsysteem (230 V) · Sistema de rieles en 2 fases (230 V) · Sistema a binario bifase (230 V) · Sistem de piste cu 2 faze (230 V) · 2-vaihekiskojärjestelmä (230 V) · 2-fazowy system prowdnic (230 V)

FR NL ES IT RO FI PL

⚠ Lors de la planification, veuillez prêter une attention particulière à la position du conducteur de protection, qui doit être connecté en permanence dans le système.

Let bij de planning absoluut op de positie van de beschermende geleider die binnen het systeem ononderbroken verbonden moet zijn.

Al planificar, por favor, tenga en cuenta la posición de la toma de tierra, que debe estar conectado a lo largo de todo el sistema.

In fase di progettazione, prestare attenzione alla posizione del conduttore di protezione, che deve essere collegato in modo continuo all'interno dell'impianto.

La planificare, luați neapărat în considerare poziția conductorului de protecție, care trebuie să fie conectat continuu în interiorul sistemului.

Huomioi suunnittelussa koko järjestelmään kytkettävän suojamaadoituksen sijainti.

Podczas projektowania należy zwrócić uwagę na położenie przewodu ochronnego, który musi być podłączony w całym systemie.

## 1 Rail

La longueur maximale de l'installation est de 30 mètres par alimentation, avec une puissance totale maximale de 600 watts par phase.

### Spoor

De maximale montagelengte bedraagt 30 meter per voeding, bij een een totaal vermogen van max. 600 watt per fase.

### Riel

La longitud máxima de montaje es de 30 metros por alimentación, con una potencia total de 600 vatios como máximo por fase.

### Binario

La lunghezza massima di installazione è di 30 metri per ogni alimentazione, con una potenza totale di max. 600 watt per fase.

### Pistă

Lungimea maximă de montaj este de 30 de metri pe fiecare sursă de alimentare, la o putere totală de max. 600 W pe fază.

### Kisko

Asennuksen enimmäispituus on 30 metriä syöttöä kohti, kokonaisteho enintään 600 W/vaihe.

### Szyna

Maksymalna długość montażu wynosi 30 metrów na linię zasilania z łączną mocą 600 watów na jedną fazę.

pueden activarse y atenuarse también mediante cables de corriente de tres filamentos.

**Alimentazione centrale/finale con variatore di fase elettrico**  
Mediante un variatore di fase elettrico, le due fasi possono essere commutate e dimmerate separatamente, anche con linee di alimentazione a tre conduttori.

**Alimentare centrală/finală cu schimbător electronic de fază**  
Prin intermediul dispozitivului electronic de schimbare a fazelor se pot comuta și regla două faze chiar și în cazul cablurilor electrice cu trei fire.

### Keski-/päätyisyttö elektronisella vaihtimella

Sähköistä vaihdinta käyttämällä nämä kaksi vaihetta voidaan kytkeä ja himmentää erikseen jopa kolmijohtimisella kaapeloinnilla.

### Zasilanie pośrednie / końcowe z elektronicznym przełącznikiem faz

Za pomocą elektronicznych zmieniaaczy faz obie fazy można przełączać i przyciemniać osobno, nawet w przypadku trójprzewodowych linii zasilania.

## 4 Connecteur longitudinal

Relie deux rails entre eux pour des sections droites.

### Longitudale verbinder

Verbindt twee sporen voor rechte stukken met elkaar.

### Ensamblaje recto

Ensamble dos rieles para tramos rectos entre si.

### Connettore longitudinale

Unisce due binari per sezioni rettilinee.

### Conector longitudinal

Conectează două piste pentru trasee drepte unele cu altele.

### Suora liitin

Yhdistää kaksi kiskoa suoria osuuksia varten.

### Przedłużacz

Łączy dwie szyny dla prostych odcinków.

## 5 Connecteur Flex

Relie deux rails entre eux sous n'importe quel angle et relie le montage au plafond à celui au mur.

### Flexibele verbinder

Verbindt twee sporen in een willekeurige hoek met elkaar en maakt de verbinding tussen plafond- en muurmontage mogelijk.

### Ensamblaje flexible

Ensamble dos rieles con cualquier ángulo entre si y permite la conexión entre el montaje en techo y paredes.

### Connettore flessibile

Collega tra loro due binari con qualsiasi angolazione e consente il collegamento tra il montaggio a soffitto e a parete.

### Conector Flex

Conectează două șine într-un unghi aleatoriu între ele și permite conectarea între sistemele de montaj pe plafon și pe perete.

### Flex-liitin

Yhdistää kaksi kiskoa mihin tahansa kulmaan ja mahdollistaa yhteyden katto- ja seinäkiinnityksen välillä.

### Łącznik elastyczny

Łączy dwie szyny pod dowolnym kątem i umożliwia połączenie między sufitem a ścianą.

## 6 Raccord en L

Relie deux rails entre eux à angle droit.

### L-Connector

Verbindt twee sporen in een rechte hoek met elkaar.

### Conector en L

Ensamble dos rieles en ángulo recto entre si.

## 2 Alimentation électrique intermédiaire/finale

L'alimentation du milieu/extrémité est montée directement au-dessus de la prise de courant et permet de connecter des rails d'un côté ou des deux côtés.

### Midden-/eindevoeding

De midden-/eindevoeding wordt direct over de stroomuitgang aangebracht en maakt het mogelijk sporen op één of beide kanten aan te sluiten.

### Alimentación medios/extremos

La alimentación de medios/extremos se adapta directamente mediante la toma de corriente, y permite que las lámparas se conecten por un lado o por los dos.

### Alimentazione centrale/finale

L'alimentazione centrale/finale è montata direttamente sopra la presa di corrente e consente di collegare le guide su un lato o su entrambi i lati.

### Alimentare centrală/finală

Alimentare centrală/finală este realizată direct prin intermediul conexiunii electrice și permite conectarea pistelor pe o parte sau pe ambele părți.

### Keski-/päätyisyttö

Keski-/päätyisyttö asennetaan suoraan pistorasian yläpuolelle, ja se mahdollistaa kiskojen kytkemisen toiselle tai molemmille puolille.

### Zasilanie pośrednie / końcowe

Zasilanie środkowe / końcowe jest instalowane bezpośrednio nad gniazdem zasilania i umożliwia podłączenie szyn z jednej lub z obu stron.

## 3 Alimentation intermédiaire/finale avec changeur de phase électronique

Grâce à un changeur de phase électronique, les deux phases peuvent être commutées et atténuées séparément, même avec des lignes électriques à trois conducteurs.

### Midden-/eindevoeding met elektronische fasewisselaar

Door middel van een elektronische fasewisselaar kunnen de twee fasen ook bij driedradige stroomleidingen apart geschakeld en gedimd worden.

### Alimentación medios/extremos con cambiador de fase electrónico

Por medio de los cambiadores de fase electrónicos, las dos fases

### **Connettore a L**

Collega insieme due binari ad angolo retto.

### **Conector în L**

Conectează două piste pentru trasee în unghi drept unele cu altele.

### **L-Liitin**

Yhdistää kaksi kiskoja toisiinsa suorassa kulmassa.

### **Złącze L**

Łączy dwie szyny pod kątem prostym.

### **8 Raccord en T**

Relie trois rails entre eux à angle droit.

### **10 T-Connector**

Verbindt drie sporen in een rechte hoek met elkaar.

### **Conector en T**

Ensemble tres rieles en ángulo recto entre si.

### **Connettore a T**

Collega insieme tre binari ad angolo retto.

### **Conector în T**

Conectează trei șine în unghi drept unele de altele.

### **T-Liitin**

Yhdistää kolme kiskoja suorassa kulmassa toisiinsa.

### **Złącze T**

Łączy trzy szyny pod kątem prostym.

### **11 Connecteur X**

Relie quatre rails entre eux à angle droit.

### **X-verbinder**

Verbindt vier sporen in een rechte hoek met elkaar.

### **Ensamblaje en X**

Ensemble cuatro rieles en ángulo recto entre si.

### **Connettore a X**

Collega insieme quattro binari ad angolo retto.

### **Conector X**

Conectează patru șine în unghi drept între ele.

### **X-liitin**

Yhdistää neljä kiskoja suorassa kulmassa toisiinsa nähden.

### **Łącznik X**

Łączy cztery szyny pod kątem prostym.

### **12 Adaptateur pendulaire**

Cet adaptateur pendulaire permet d'intégrer des luminaires suspendus conventionnels dans le système de rail DUOline.

### **Hangadapter**

Deze hangadapter maakt het mogelijk gewone hanglampen in het DUOline-spoorsysteem te integreren.

### **Adaptador colgante**

Este adaptador colgante le permite integrar las lámpara colgantes convencionales en el sistema de rieles de DUOline.

### **Adattatore per sospensione**

Questo adattatore per sospensione consente l'integrazione di lampade a sospensione convenzionali nel sistema a binario DUOline.

### **Adaptor lustre**

Acest adaptor pendular permite integrarea lustrelor uzuale în sistemul de piste DUOline.

### **Riippuvalaisinsovitin**

Tämä riippuvalaisinsovitin mahdollistaa tavallisten riippuvalaisimien integroinnin DUOline-kiskojärjestelmään.

### **Adapter zawieszania**

Ten adapter do zawieszania umożliwia zintegrowanie tradycyjnych lamp wiszących z systemem szyn DUOline.

### **14 Raccourcisseur de câble**

Permet de raccourcir les câbles des luminaires suspendus.

### **Snoerverkorter**

Maakt het inkorten van het snoer van hanglampen mogelijk.

### **Acortador de cable**

Es posible acortar el cable de las lámparas colgantes.

### **Sistema per accorciare il cavo**

Permette di accorciare i cavi delle lampade a sospensione.

### **Prescurtare cablu**

Permite scurtaarea cablurilor lustrelor.

### **Johdon lyhennin**

Mahdollistaa riippuvalaisimen johdon lyhentämisen.

### **Skracacz kabla**

Pozwala skrócić kable lamp wiszących.

### **15 Suspension**

### **16 Afstandhouder**

### **Suspensión**

### **Sospensione**

### **Suspensie**

### **Ripustus**

### **Zawieszenie**

### **17 Embouts**

### **Eindkappen**

### **Tapones**

### **Tappi terminali**

### **Capace de capăt**

### **Päätykappaleet**

### **Zaślepki**

### **18 Couvercle de remplacement de l'adaptateur**

### **Vervangende afdekking voor adapter**

### **Tapa de recambio para adaptador**

### **Coperchio di ricambio per adattatore**

### **Capac de înlocuire pentru adaptor**

### **Adapterin korvaava suojus**

### **Wymienna pokrywa adaptera**

### **21 Isolateur**

Grâce à un isolateur, deux circuits séparés peuvent être reliés optiquement pour former un système.

### **Isolator**

Door middel van de isolator kunnen twee aparte stroomkringen optisch verbonden worden tot één systeem.

### **Aislador**

Por medio del aislador pueden conectarse dos circuitos de forma óptica a un sistema.

### **Isolatore**

Utilizzando un isolatore, due circuiti separati possono essere collegati otticamente per formare un sistema.

### **Izolator**

Prin intermediul izolatorului este posibilă conectarea optică a două circuite de comutare într-un sistem.

### **Eristin**

Eristimen avulla kaksi erillistä piiriä voidaan kytkeä optisesti yhden järjestelmän muodostamiseksi.

### **Izolator**

Za pomocą izolatora można optycznie połączyć dwa oddzielne obwody w celu utworzenia systemu.

### **22 Alimentation électrique flexible**

L'alimentation électrique flexible est nécessaire si les rails ne peuvent pas être posés directement sur la prise de courant.

### **Flexibele stroomtoevoer**

Flexibele stroomtoevoer is nodig, als de sporen niet direct over de stroomuitgang gelegd kunnen worden.

### **Suministro de corriente flexible**

El suministro de corriente flexible será necesario si las lámparas no pueden desplegarse directamente sobre la toma de corriente.

### **Sistema di alimentazione flessibile**

Il sistema di alimentazione flessibile è necessario se i binari non possono essere posati direttamente sulla presa di corrente.

### **Alimentarea electrică flexibilă**

Alimentarea electrică flexibilă este necesară atunci când pistele nu pot fi pozate direct prin intermediul racordului electric.

### **Joustava virransyöttö**

Joustava virtalähde on tarpeen, jos kiskoja ei voida asentaa suoraan pistorasian yläpuolelle.

### **Elastyczne zasilani**

Elastyczny zasilanie jest wymagane, jeśli szyny nie mogą być układane bezpośrednio nad gniazdem zasilania.

### **23 Profil encastré**

### **Verzonken profiel**

### **Perfil empotrado**

### **Profilo incassato**

### **Profil încastrat**

### **Upotettu profiili**

### **Profil wpuszczany**

# INDEX · NUMERIC

Seite Page	Artikel-Nr. Product No.	EAN-Nummer EAN-Number	Seite Page	Artikel-Nr. Product No.	EAN-Nummer EAN-Number	Seite Page	Artikel-Nr. Product No.	EAN-Nummer EAN-Number
204	101000324	4017807504675	380	222570231	4017807399875	392	273070701	4017807284706
204	101000524	4017807504682	380	222570232	4017807399882	392	273071301	4017807284713
236	101600506	4017807430165	370	223310105	4017807371765	392	273071801	4017807284720
236	101600806	4017807430172	370	223310131	4017807371772	393	273370307	4017807284799
278	110600331	4017807343656	370	223310132	4017807371789	378	274670105	4017807293968
278	110600531	4017807343670	370	223410131	4017807303025	382	274770132	4017807390056
206	110700328	4017807354140	370	223410132	4017807306309	389	279770104	4017807275346
206	110700528	4017807354164	152	223510131	4017807421859	389	279770107	4017807275353
386	200200132	4017807463019	152	223510132	4017807421910	389	279770108	4017807275360
386	200300132	4017807462982	86	223710130	4017807441871	389	279770132	4017807542363
386	200600132	4017807462821	86	223790130	4017807441895	558	2803021-06	4017807147599
206	200700128	4017807354188	368	224110179	4017807329018	558	2803031-06	4017807147605
362	201000101	4017807409642	372	224210102	4017807465914	534	281470306	4017807615647
362	201100201	4017807409666	372	224290102	4017807465921	534	281470332	4017807615630
252	201200100	4017807398632	373	224810132	4017807502756	534	281479306	4017807615661
230	202000108	4017807436051	373	224819132	4017807502787	534	281479332	4017807615654
228	202000132	4017807506372	374	225172924	4017807404517	540	282410106	4017807280821
228	202000142	4017807432893	374	225172931	4017807404555	540	282410206	4017807280838
250	202500101	4017807364927	374	225172942	4017807433401	547	282990106	4017807345070
390	202620131	4017807575057	374	225174731	4017807404593	542	283110206	4017807382853
390	202620132	4017807575040	374	225174742	4017807433425	542	283110232	4017807508024
390	202670107	4017807524017	388	225210104	4017807256314	548	283270106	4017807384048
390	202670108	4017807526547	388	225210107	4017807256338	548	283270132	4017807508116
390	202670131	4017807524055	378	225510207	4017807277913	548	283270206	4017807384055
390	202670132	4017807524079	384	229210207	4017807413304	548	283270232	4017807508123
58	203000132	4017807522716	384	229210231	4017807413281	548	283270306	4017807384062
254	204400101	4017807364972	384	229210232	4017807413298	548	283270332	4017807508154
74	205570167	4017807442540	366	240310131	4017807581089	548	283274106	4017807622652
74	205570267	4017807442564	367	240310179	4017807581072	548	283274206	4017807622669
369	206400279	4017807364361	366	240319131	4017807581065	548	283274306	4017807622676
369	206500279	4017807364378	367	240319179	4017807581058	553	283400106	4017807508246
198	208070132	4017807407242	112	241810205	4017807541793	553	283400132	4017807508253
413	208870132	4017807388473	112	241810208	4017807541861	552	283500106	4017807513967
428	209100107	4017807398564	300	242910180	4017807550726	552	283500132	4017807513998
428	209100108	4017807398571	376	248510231	4017807614718	544	283600406	4017807514018
256	212200100	4017807522013	376	248510232	4017807614725	546	283770106	4017807508079
476	212400201	4017807408799	376	248570131	4017807614732	546	283770132	4017807508086
478	212400204	4017807490510	376	248570132	4017807614749	546	283779106	4017807508093
476	212400207	4017807408850	381	248670131	4017807614770	546	283779132	4017807508109
476	212400224	4017807408867	381	248670132	4017807614787	532	283811206	4017807507997
476	212400232	4017807408812	361	2522011-06	4017807080797	532	283811232	4017807507980
474	212400265	4017807612417	106	254910132	4017807616866	532	283814206	4017807507959
361	212700104	4017807522129	106	254910165	4017807627350	532	283814232	4017807507942
361	212700107	4017807522112	383	262670131	4017807614756	532	283817906	4017807507966
361	212700204	4017807522143	383	262670132	4017807614763	532	283817932	4017807507973
361	212700207	4017807522136	64	263300130	4017807616514	533	283916006	4017807507904
75	212870236	4017807567977	424	263470176	4017807613766	533	283916032	4017807507911
75	212879236	4017807567960	424	263470180	4017807613759	533	283919006	4017807507928
430	214470108	4017807539523	270	271170201	4017807247251	533	283919032	4017807507935
430	214470132	4017807539554	270	271170202	4017807247268	536	284071206	4017807507638
371	218600231	4017807613032	270	271170211	4017807508680	536	284071232	4017807507645
371	218600280	4017807613025	385	271470207	4017807374681	536	284074206	4017807507676
379	220810201	4017807258363	385	271470279	4017807374698	536	284074232	4017807507683
379	220810205	4017807258370	393	272970701	4017807284676	536	284077906	4017807507652
384	222370231	4017807387025	393	272970787	4017807284683	536	284077932	4017807507669
384	222370232	4017807387032	392	273070401	4017807284690	550	284114006	4017807507591

Seite Page	Artikel-Nr. Product No.	EAN-Nummer EAN-Number	Seite Page	Artikel-Nr. Product No.	EAN-Nummer EAN-Number	Seite Page	Artikel-Nr. Product No.	EAN-Nummer EAN-Number
550	284114032	4017807507607	200	306700632	4017807364392	220	317000332	4017807542271
550	284116006	4017807507614	200	306700732	4017807399905	220	317000613	4017807577730
550	284116032	4017807507621	242	308000132	4017807288827	220	317000632	4017807542295
543	284270106	4017807585278	282	308200179	4017807392517	220	317000813	4017807577679
543	284270132	4017807585285	226	308500542	4017807468601	220	317000832	4017807542301
545	284470132	4017807615678	226	308590342	4017807468625	280	319000344	4017807574135
545	284470332	4017807615685	243	309300302	4017807354102	178	319400132	4017807613773
530	284770106	4017807616798	154	309800431	4017807387681	178	319400141	4017807613780
530	284770132	4017807616781	154	309800432	4017807387698	178	319400144	4017807613803
530	284779106	4017807616811	240	309900631	4017807330946	178	319400165	4017807613797
530	284779132	4017807616804	240	309900632	4017807330953	178	319400417	4017807574593
238	300600342	4017807467345	240	309900657	4017807573657	178	319400617	4017807574623
61	301000367	4017807478167	202	310100104	4017807408607	178	319430317	4017807574609
252	301200300	4017807398649	202	310100204	4017807408591	246	319500207	4017807574654
188	301300142	4017807390322	203	310100562	4017807356045	246	319500232	4017807574630
188	301300342	4017807390346	218	310300132	4017807532951	246	319500307	4017807574661
188	301300442	4017807390353	218	310300532	4017807522471	246	319500332	4017807574647
258	301400101	4017807195422	218	310390332	4017807522488	214	319800108	4017807614497
259	301700107	4017807196009	187	310500332	4017807566826	214	319800132	4017807614558
259	301700108	4017807196016	187	310500632	4017807566864	214	319800608	4017807614510
68	301900467	4017807502602	244	310600132	4017807427264	214	319800632	4017807614572
230	302000308	4017807436112	244	310600154	4017807507478	212	319800808	4017807614527
228	302000332	4017807506389	244	310600432	4017807427288	212	319800832	4017807614589
228	302000342	4017807433067	244	310600454	4017807507515	212	319830308	4017807614503
230	302000608	4017807522778	244	310630332	4017807435696	212	319830332	4017807614565
78	302100130	4017807451252	244	310630354	4017807507492	120	320310307	4017807487909
78	302100430	4017807451269	186	310800108	4017807503845	120	320310308	4017807487916
182	302400432	4017807523515	186	310800308	4017807503852	120	320310331	4017807487930
184	302400480	4017807523454	186	310890108	4017807503838	120	320310332	4017807487923
182	302400632	4017807523652	199	311100308	4017807537826	110	321210107	4017807454000
184	302400680	4017807523614	234	311210506	4017807367768	110	321210108	4017807461145
250	302500301	4017807364934	234	311210606	4017807367775	148	321611131	4017807468724
58	303000132	4017807476781	266	311400132	4017807538526	148	321611132	4017807468731
58	303090132	4017807476798	266	311400432	4017807538410	148	321691131	4017807468748
264	303100417	4017807567779	279	311600506	4017807581157	148	321691132	4017807468755
272	303300102	4017807288308	279	311630306	4017807581164	131	321710107	4017807430486
272	303300111	4017807508703	60	312200136	4017807544817	131	321710142	4017807430493
70	303400167	4017807425376	256	312200200	4017807522006	126	321910307	4017807453584
70	303400367	4017807425383	60	312200336	4017807544800	126	321910342	4017807453607
152	303500331	4017807422061	56	312300136	4017807504620	136	322610431	4017807424294
152	303500332	4017807422078	182	312400101	4017807408713	136	322610432	4017807424300
258	304100100	4017807247411	182	312400107	4017807408737	88	322910532	4017807524963
258	304100106	4017807247404	182	312400132	4017807408720	86	323710130	4017807451191
82	304300132	4017807467499	182	312400401	4017807408751	133	325010105	4017807422627
82	304300134	4017807600544	182	312400407	4017807408775	133	325010132	4017807422634
80	304300432	4017807467567	182	312400432	4017807408768	134	326210107	4017807505221
80	304300434	4017807600520	184	312490432	4017807523720	134	326210132	4017807505214
82	304330332	4017807467512	184	312490632	4017807523843	168	326510107	4017807510034
82	304330334	4017807600537	66	312700132	4017807502725	168	326510142	4017807510058
254	304400201	4017807364989	66	312700432	4017807502718	168	326510207	4017807510065
239	304800142	4017807277944	85	313800332	4017807502855	168	326510242	4017807510089
276	305400401	4017807336948	85	313800532	4017807502862	168	326510307	4017807510096
276	305400411	4017807336955	261	313900132	4017807505061	168	326510342	4017807510119
276	305400441	4017807391022	84	315900132	4017807540246	98	326610232	4017807505474
84	305900126	4017807330816	84	315900142	4017807540277	116	326810132	4017807506518
84	305900130	4017807330809	220	317000313	4017807597080	150	340910132	4017807537970

# INDEX · NUMERIC

Seite Page	Artikel-Nr. Product No.	EAN-Nummer EAN-Number	Seite Page	Artikel-Nr. Product No.	EAN-Nummer EAN-Number	Seite Page	Artikel-Nr. Product No.	EAN-Nummer EAN-Number
150	340910332	4017807538106	104	354930332	4017807616897	130	371310105	4017807445336
114	341210305	4017807540161	104	354930365	4017807627398	130	371310131	4017807451801
114	341210308	4017807540086	260	3590010-01	4017807062496	130	371310142	4017807445343
96	341610132	4017807542455	222	362800132	4017807615791	248	3751031-07	4017807137729
112	341810205	4017807540710	222	362800432	4017807615814	248	3751041-07	4017807137736
112	341810208	4017807540734	222	362830332	4017807615807	248	3751051-07	4017807169027
172	342010107	4017807542066	232	363100108	4017807616217	158	375310502	4017807504446
172	342010108	4017807542080	232	363100132	4017807616200	158	375310505	4017807504439
172	342010132	4017807542073	232	363190108	4017807616231	158	375310507	4017807472226
172	342010207	4017807542097	232	363190132	4017807616224	158	375310532	4017807472233
172	342010208	4017807542134	180	364000131	4017807613957	160	375390531	4017807613018
172	342010307	4017807542141	180	364000132	4017807613964	160	375390532	4017807613001
172	342010308	4017807542158	180	364000165	4017807613971	166	375510407	4017807469844
172	342010332	4017807542172	180	364000417	4017807614008	166	375510432	4017807469882
162	343310105	4017807597929	180	364000431	4017807613988	167	379190707	4017807362831
162	343310132	4017807597950	180	364000432	4017807613995	167	379190732	4017807471229
162	343310165	4017807597967	180	364000617	4017807614039	432	400200107	4017807368390
164	343310305	4017807577822	180	364000631	4017807614015	432	400200108	4017807378320
164	343310332	4017807577839	180	364000632	4017807614022	434	400400107	4017807423211
164	343310365	4017807577815	180	364030317	4017807623901	434	400400132	4017807423228
174	343610307	4017807577570	180	364030331	4017807623888	204	401000224	4017807504712
174	343610308	4017807579673	180	364030332	4017807623895	274	401100101	4017807276121
128	344110105	4017807577907	216	364100832	4017807612929	72	401200101	4017807502640
128	344110165	4017807577860	216	364130532	4017807612912	68	401900367	4017807502619
128	344110180	4017807579833	210	364200154	4017807616828	230	402000108	4017807436099
140	345619131	4017807600919	210	364200417	4017807616842	228	402000132	4017807506426
140	345619132	4017807600926	210	364230317	4017807616835	228	402000142	4017807433012
118	347710407	4017807610321	40	364600417	4017807622997	73	402690167	4017807502688
118	347710431	4017807610338	40	364630317	4017807622980	58	403000132	4017807468076
118	347710432	4017807610345	54	364700144	4017807617252	264	403100317	4017807567786
118	347710465	4017807610352	54	364790144	4017807617245	409	403400317	4017807422986
118	347710480	4017807610369	192	365290104	4017807617344	270	403900201	4017807433654
260	3490400-00	4017807062465	193	365300104	4017807617405	435	403900201	4017807433654
122	349110131	4017807616033	194	365400304	4017807617504	270	403900208	4017807494556
122	349110132	4017807616026	194	365400332	4017807617498	435	403900208	4017807494556
122	349110179	4017807616040	194	365420104	4017807617443	270	403900211	4017807433661
122	349119131	4017807616064	194	365420132	4017807617436	435	403900211	4017807433661
122	349119132	4017807616057	194	365430104	4017807617481	82	404300332	4017807467727
122	349119179	4017807616071	194	365430132	4017807617474	412	404600332	4017807377361
144	349614531	4017807613834	194	365440104	4017807617467	200	406700632	4017807364415
144	349614532	4017807613841	194	365440132	4017807617450	198	408000132	4017807407303
144	349616031	4017807613858	196	365700132	4017807617559	282	408200179	4017807392593
144	349616032	4017807613865	196	365700166	4017807617566	282	408290179	4017807392616
144	349617531	4017807613872	196	365700332	4017807617573	226	408500542	4017807468670
144	349617532	4017807613889	196	365700366	4017807617580	413	408800332	4017807390148
156	349710107	4017807616675	196	365790132	4017807617535	428	409100307	4017807389654
156	349710132	4017807616668	196	365790166	4017807617542	428	409100308	4017807389661
156	349710176	4017807616682	51	366700136	4017807617634	234	411210406	4017807367836
108	352011117	4017807616705	51	366790136	4017807629293	266	411400132	4017807538618
108	352091117	4017807616699	52	366800136	4017807617641	266	411400232	4017807538731
124	352710307	4017807453775	52	366800436	4017807617689	266	411490132	4017807538687
124	352710342	4017807473308	52	366890136	4017807628265	408	411700107	4017807575231
106	354910132	4017807616880	249	371010307	4017807281750	408	411700108	4017807522501
106	354910165	4017807627381	249	371010308	4017807281767	56	412300136	4017807561302
106	354910432	4017807616903	249	371010407	4017807281781	410	412400107	4017807488777
106	354910465	4017807627404	249	371010408	4017807281798	410	412400108	4017807488760

Seite Page	Artikel-Nr. Product No.	EAN-Nummer EAN-Number	Seite Page	Artikel-Nr. Product No.	EAN-Nummer EAN-Number	Seite Page	Artikel-Nr. Product No.	EAN-Nummer EAN-Number
410	412400131	4017807488784	114	441210308	4017807540390	439	505200149	4017807568745
410	412400132	4017807488791	96	441610132	4017807542530	439	505200177	4017807568776
410	412400507	4017807612356	112	441810205	4017807540765	439	505200183	4017807568684
410	412400532	4017807612363	112	441810208	4017807541731	440	506200131	4017807560831
66	412700132	4017807502732	422	445210131	4017807600025	440	506200132	4017807560824
430	414400108	4017807539455	422	445210132	4017807600018	440	506290131	4017807560879
430	414400132	4017807539486	94	447610232	4017807600476	440	506290132	4017807560848
220	417000313	4017807597097	415	448810132	4017807615692	198	508000132	4017807407280
220	417000332	4017807581201	415	448810176	4017807615708	282	508200179	4017807392555
280	419090144	4017807574159	396	449510207	4017807618129	428	509100107	4017807398540
427	419200131	4017807574531	396	449510232	4017807618112	428	509100108	4017807398557
427	419200141	4017807574524	396	449510279	4017807627923	274	511100101	4017807246841
178	419400217	4017807613827	108	452010317	4017807616729	234	511210306	4017807367829
178	419400232	4017807613810	104	454910132	4017807616910	268	511400132	4017807538755
417	420490107	4017807295337	104	454910165	4017807627428	410	512400107	4017807488746
417	420490132	4017807382525	204	4602021-24	4017807196801	410	512400108	4017807488753
419	420810107	4017807367614	274	461100101	4017807247220	410	512400131	4017807488722
418	420910107	4017807367591	426	462100132	4017807398922	410	512400132	4017807488739
418	420910108	4017807367607	232	463100108	4017807616156	63	514110101	4017807600070
110	421210107	4017807454024	232	463100132	4017807616149	63	514110102	4017807600049
110	421210108	4017807461169	64	463300330	4017807616507	63	514110130	4017807599985
405	421910207	4017807267532	424	463400176	4017807613742	430	514400108	4017807539370
136	422610531	4017807423822	424	463400180	4017807613735	430	514400132	4017807539400
136	422610532	4017807423853	44	465000132	4017807617177	436	517800113	4017807601053
398	422710307	4017807343076	44	465000176	4017807617160	436	517800115	4017807601060
398	422710308	4017807354270	193	465300104	4017807617429	436	517800154	4017807601039
420	423310107	4017807505825	50	467200130	4017807617696	436	517900111	4017807601091
420	423310108	4017807506105	132	472910106	4017807299281	436	517900112	4017807601107
420	423310131	4017807588668	416	473190332	4017807382532	436	517900113	4017807601077
420	423310132	4017807506099	414	474410179	4017807359633	436	517900115	4017807602401
138	423410107	4017807506297	433	475310307	4017807380439	62	518900101	4017807614701
138	423410131	4017807506310	433	475310379	4017807380446	62	518990101	4017807614695
138	423410132	4017807506327	404	478310206	4017807336795	280	519000144	4017807574142
402	424210304	4017807467635	432	500200107	4017807368406	442	519300103	4017807600704
402	424210307	4017807467628	432	500200108	4017807378313	442	519300106	4017807600711
402	424210332	4017807467598	206	500700128	4017807354201	212	519800108	4017807614534
404	424910207	4017807353938	204	501000224	4017807504729	212	519800132	4017807614596
400	425610204	4017807525243	274	501100101	4017807246810	418	520910107	4017807367577
400	425610207	4017807525229	230	502000108	4017807436075	418	520910108	4017807367584
400	425610232	4017807525267	228	502000132	4017807506402	110	521210107	4017807454017
134	426219107	4017807505276	228	502000142	4017807432992	110	521210108	4017807461152
134	426219132	4017807505269	78	502100130	4017807473476	136	522610331	4017807423792
99	426410130	4017807505450	458	5027011-01	4017807017366	136	522610332	4017807423815
405	426410207	4017807244717	458	5027011-17	4017807051360	452	523090131	4017807502503
405	426410208	4017807244724	458	5027011-47	4017807124941	452	523090132	4017807502527
170	426510104	4017807525342	459	5028010-01	4017807051414	420	523310107	4017807505771
170	426510107	4017807525335	459	5028010-02	4017807051421	420	523310108	4017807505818
170	426510142	4017807525366	459	5028010-17	4017807051438	420	523310131	4017807588675
170	426510204	4017807525281	459	5028010-47	4017807051445	420	523310132	4017807505801
170	426510207	4017807525274	459	5029010-01	4017807051377	446	525490106	4017807371710
170	426510242	4017807525311	459	5029010-47	4017807051407	446	525490107	4017807371727
407	426511832	4017807467390	264	503100144	4017807567793	444	525790107	4017807385663
116	426810132	4017807506501	82	504300132	4017807467703	444	525790108	4017807385670
406	427511801	4017807274332	456	504900104	4017807522570	170	526510104	4017807525373
406	427511802	4017807274349	456	504900107	4017807522556	170	526510107	4017807510140
114	441210305	4017807540413	439	505200112	4017807568790	170	526510142	4017807510164

# INDEX . NUMERIC

Seite Page	Artikel-Nr. Product No.	EAN-Nummer EAN-Number	Seite Page	Artikel-Nr. Product No.	EAN-Nummer EAN-Number	Seite Page	Artikel-Nr. Product No.	EAN-Nummer EAN-Number
454	527090111	4017807372328	416	573190107	4017807302677	200	606700632	4017807373448
454	527090131	4017807372335	433	575310307	4017807380453	365	606900132	4017807504170
455	527290101	4017807291438	433	575310379	4017807380460	365	606900162	4017807356823
455	527290102	4017807291445	457	579790104	4017807275285	365	606903032	4017807512069
444	527590107	4017807371758	457	579790107	4017807275322	365	606905032	4017807512038
453	527920101	4017807276046	457	579790108	4017807275339	364	608100224	4017807211795
453	527920102	4017807276053	457	579790132	4017807452549	364	608100324	4017807211788
449	529690100	4017807262032	448	590100107	4017807551129	282	608200279	4017807392531
445	529990103	4017807248340	448	590100132	4017807551136	154	609800431	4017807387704
445	529990107	4017807248364	448	590200107	4017807551143	154	609800432	4017807387711
114	541210205	4017807540284	448	590200132	4017807551150	240	609900331	4017807330960
114	541210208	4017807540253	449	591000107	4017807551167	240	609900332	4017807330984
96	541610132	4017807542493	449	591000132	4017807551174	240	609900357	4017807573671
112	541810205	4017807541748	445	592300107	4017807551211	204	6102021-24	4017807053296
112	541810208	4017807541762	276	595400101	4017807337778	360	6105011-01	4017807053968
422	545210131	4017807600001	276	595400111	4017807337785	360	6105021-01	4017807098440
422	545210132	4017807599992	276	595400179	4017807337792	199	611100308	4017807537789
450	545310131	4017807600193	446	595700106	4017807551273	234	611210506	4017807367782
450	545310132	4017807600216	446	595700107	4017807551280	268	611400332	4017807538700
94	547610232	4017807600469	446	595700108	4017807551297	268	611400532	4017807544572
451	549010131	4017807616002	447	599100106	4017807551303	268	611490332	4017807544565
451	549010132	4017807615999	447	599100107	4017807551310	77	611500201	4017807526158
108	552010165	4017807616712	447	599100108	4017807551327	77	611500202	4017807526165
104	554910132	4017807616873	447	599100118	4017807551334	77	611500301	4017807526202
104	554910165	4017807627374	438	599700101	4017807551358	77	611500302	4017807526219
440	562900132	4017807616132	438	599700115	4017807551365	256	612200100	4017807522037
440	562900144	4017807616118	438	599700119	4017807551372	256	612200200	4017807522051
440	562900165	4017807616125	438	599700142	4017807551389	56	612300236	4017807504637
232	563100108	4017807616170	206	600700328	4017807354225	476	612400501	4017807411614
232	563100132	4017807616163	204	601000324	4017807504699	478	612400504	4017807490619
64	563300130	4017807616491	252	601200100	4017807398601	476	612400507	4017807411638
424	563400176	4017807613728	252	601200200	4017807398618	476	612400532	4017807411621
424	563400180	4017807613711	68	601900467	4017807502596	478	612400580	4017807523980
180	564000131	4017807614046	78	602100130	4017807491500	320	612900131	4017807426441
180	564000132	4017807614053	250	602500101	4017807364941	320	612900132	4017807426465
180	564000165	4017807614060	250	602500201	4017807364958	320	612900134	4017807558876
216	564100132	4017807628036	264	603100244	4017807567748	320	612900180	4017807558890
210	564200113	4017807627886	264	603100344	4017807567755	320	612900231	4017807426526
210	564200115	4017807627893	264	603130317	4017807573817	320	612900232	4017807426533
210	564200154	4017807616859	362	603300101	4017807433784	321	613000131	4017807426908
42	564900157	4017807620603	152	603500331	4017807422047	321	613000132	4017807426915
42	564990157	4017807620597	152	603500332	4017807422054	321	613000134	4017807558913
44	565000132	4017807617139	272	603900301	4017807256536	321	613000180	4017807558937
44	565000176	4017807617122	272	603900302	4017807256543	321	613000231	4017807426922
196	565700132	4017807629071	272	603900311	4017807505627	321	613000232	4017807426939
196	565700166	4017807629088	272	603900501	4017807369298	312	616700306	4017807541687
196	565790132	4017807629095	272	603900502	4017807369304	312	616700506	4017807541700
196	565790166	4017807629101	272	603900511	4017807505634	280	619000244	4017807574128
52	566800136	4017807617672	254	604400101	4017807364996	178	619430317	4017807574616
50	567200130	4017807617702	254	604400201	4017807365009	360	6196011-01	4017807138238
43	568100111	4017807617221	322	604900331	4017807454284	360	6196011-07	4017807138245
43	568190111	4017807625936	322	604900332	4017807454307	214	619800308	4017807614541
443	568200132	4017807622683	322	604900631	4017807454345	214	619800332	4017807614602
443	568200165	4017807616477	322	604900632	4017807454369	314	620010407	4017807449525
443	568200176	4017807616484	276	605400501	4017807349214	314	620010408	4017807550788
132	572910106	4017807303162	276	605400511	4017807349221	314	620010431	4017807452204



Seite Page	Artikel-Nr. Product No.	EAN-Nummer EAN-Number	Seite Page	Artikel-Nr. Product No.	EAN-Nummer EAN-Number	Seite Page	Artikel-Nr. Product No.	EAN-Nummer EAN-Number
314	620010442	4017807449495	323	627710532	4017807448184	140	645610131	4017807600353
120	620310307	4017807487862	330	628410507	4017807504071	140	645610132	4017807600834
120	620310308	4017807487893	330	628410532	4017807504040	140	645619131	4017807600858
120	620310331	4017807487879	356	628513001	4017807298819	140	645619132	4017807600865
120	620310332	4017807487886	356	628613001	4017807298826	294	647110131	4017807575293
316	620510307	4017807488586	351	628915001	4017807272307	76	647410102	4017807600568
316	620510331	4017807488579	295	629210331	4017807525113	76	647410130	4017807600551
316	620510332	4017807488562	295	629219331	4017807525120	298	647510231	4017807600575
110	621210107	4017807453980	150	640910132	4017807537925	298	647510232	4017807600582
110	621210108	4017807461121	93	641110231	4017807572131	298	647510280	4017807600599
110	621290107	4017807453997	93	641110232	4017807572148	298	647519231	4017807600605
110	621290108	4017807461138	93	641110331	4017807572155	298	647519232	4017807600612
131	621710107	4017807430509	93	641110332	4017807572162	298	647519280	4017807600629
131	621710142	4017807430516	114	641210305	4017807539936	118	647710407	4017807610284
338	621910317	4017807504019	114	641210308	4017807539912	118	647710431	4017807610277
338	621912401	4017807337143	348	641310208	4017807575019	118	647710432	4017807610291
338	621912411	4017807337150	348	641310231	4017807574999	118	647710465	4017807610307
338	621914001	4017807384468	348	641310232	4017807575002	118	647710480	4017807610314
338	621914011	4017807384475	348	641310265	4017807575026	289	648110605	4017807612974
136	622610431	4017807424270	336	641412107	4017807539226	289	648110680	4017807612967
136	622610432	4017807424287	296	641510207	4017807574395	286	648310505	4017807614619
136	622610531	4017807488821	296	641510280	4017807574401	286	648310532	4017807622904
136	622610532	4017807488838	296	641519207	4017807574418	286	648310580	4017807614626
88	622910332	4017807524994	296	641519280	4017807574425	286	648310705	4017807627305
88	622910532	4017807524987	340	641710287	4017807581195	286	648310732	4017807627312
138	623410207	4017807506235	340	641719187	4017807581171	286	648310780	4017807627329
138	623410231	4017807506242	340	641719287	4017807581188	90	648911332	4017807615951
138	623410232	4017807506259	112	641810205	4017807540741	90	648914532	4017807615975
138	623419207	4017807506266	112	641810208	4017807540758	90	648917532	4017807615968
138	623419232	4017807506280	288	641910205	4017807541939	122	649110131	4017807616095
86	623710130	4017807451184	288	641910208	4017807541953	122	649110132	4017807616088
368	624110279	4017807337051	310	642110331	4017807541830	122	649110179	4017807616101
133	625010105	4017807422641	310	642110332	4017807541816	146	649614531	4017807613896
294	625815031	4017807506457	310	642110431	4017807541908	146	649614532	4017807613902
134	626210107	4017807505191	310	642110432	4017807541885	146	649616031	4017807613919
134	626210132	4017807505184	300	642910280	4017807542974	146	649616032	4017807613926
99	626410530	4017807505429	300	642910380	4017807542998	146	649617531	4017807613933
170	626510304	4017807538144	306	643010306	4017807574739	146	649617532	4017807613940
170	626510307	4017807538083	306	643010307	4017807574760	526	650000106	4017807376210
170	626510342	4017807538168	306	643010332	4017807574746	526	650000107	4017807376234
358	626510987	4017807245202	306	643010365	4017807574753	526	650000108	4017807376241
358	626511287	4017807245226	291	643110131	4017807599848	526	650000131	4017807376203
358	626512587	4017807246803	291	643110132	4017807599862	526	650000132	4017807378061
98	626610232	4017807505498	92	643210332	4017807577075	526	650000306	4017807376258
344	627413031	4017807525007	92	643210432	4017807577082	526	650000307	4017807376265
344	627413032	4017807525014	308	643810232	4017807588446	526	650000331	4017807376272
344	627413087	4017807525021	308	643810287	4017807588453	526	650100106	4017807376302
344	627415031	4017807525038	308	643810332	4017807588415	526	650100107	4017807376319
344	627415032	4017807525069	308	643810387	4017807588439	526	650100108	4017807376326
344	627415087	4017807525076	308	643810432	4017807577051	526	650100131	4017807376296
344	627417531	4017807525083	308	643810487	4017807577068	526	650100132	4017807378078
344	627417532	4017807525090	128	644110105	4017807577914	526	650100306	4017807376333
344	627417587	4017807525106	128	644110165	4017807577877	526	650100307	4017807376340
357	627514000	4017807401837	128	644110180	4017807579840	526	650100331	4017807376357
357	627516000	4017807401820	290	644810107	4017807580952	523	650310106	4017807376463
323	627710432	4017807442182	290	644810132	4017807580945	523	650310107	4017807376470

# INDEX · NUMERIC

Seite Page	Artikel-Nr. Product No.	EAN-Nummer EAN-Number	Seite Page	Artikel-Nr. Product No.	EAN-Nummer EAN-Number	Seite Page	Artikel-Nr. Product No.	EAN-Nummer EAN-Number
523	650310131	4017807376456	292	653210676	4017807614084	342	674014507	4017807363654
520	650410107	4017807376647	292	653210680	4017807614091	342	674016207	4017807363692
520	650410131	4017807376623	518	653410106	4017807574432	342	674093007	4017807363623
520	650410132	4017807378030	518	653410131	4017807574449	342	674094507	4017807363647
520	650510107	4017807376760	518	653410132	4017807574456	342	674096207	4017807363685
520	650510131	4017807376722	519	653610106	4017807574463	335	674410331	4017807477108
520	650510132	4017807378085	519	653610131	4017807574487	332	674610507	4017807385786
521	650610107	4017807376876	519	653610132	4017807574500	332	674610532	4017807575118
521	650610131	4017807376890	519	653610306	4017807574470	332	674610707	4017807450224
521	650610132	4017807442595	519	653610331	4017807574494	350	675610106	4017807363302
521	650710107	4017807376944	519	653610332	4017807574517	318	676210307	4017807371918
521	650710131	4017807376951	354	656010100	4017807389845	318	676210342	4017807425703
521	650710132	4017807442601	359	656411506	4017807371796	318	676210407	4017807425734
466	651000107	4017807573947	359	656511806	4017807371826	318	676210442	4017807425758
466	651000131	4017807573923	554	659011801	4017807280081	318	676240331	4017807524901
466	651000132	4017807573930	554	659011806	4017807508413	318	676240431	4017807524949
466	651000207	4017807573978	554	659011832	4017807508406	355	677718000	4017807337686
466	651000231	4017807573954	554	659011887	4017807280098	352	678710006	4017807337730
466	651000232	4017807573961	556	659411806	4017807280050	352	678711206	4017807337716
466	651000307	4017807574005	556	659412406	4017807280074	352	678713006	4017807337723
466	651000331	4017807573985	224	662800632	4017807615869	353	679210106	4017807440348
466	651000332	4017807573992	232	663100108	4017807616194	336	679511532	4017807450767
331	651210507	4017807389753	232	663100132	4017807616187	559	6801011-01	4017807259056
524	651500131	4017807455915	54	664700144	4017807617269	559	6801011-06	4017807147575
524	651500132	4017807455939	52	666800136	4017807617658	559	6801011-07	4017807147582
524	651600131	4017807455946	329	670710507	4017807503470	559	6801011-32	4017807507690
524	651600132	4017807455977	329	670710532	4017807503456	560	680213500	4017807508475
524	651600231	4017807456011	328	670810607	4017807503531	560	680214800	4017807508482
524	651600232	4017807455991	328	670810632	4017807503524	556	680310106	4017807508437
522	651700152	4017807425888	346	671210131	4017807489835	556	680310132	4017807508444
522	651800152	4017807425901	346	671210132	4017807489842	555	680810306	4017807508505
522	652100152	4017807425925	346	671290131	4017807489859	555	680810332	4017807508512
522	652200152	4017807425949	346	671290132	4017807489866	555	680819306	4017807508529
516	652310106	4017807427660	130	671310105	4017807445329	555	680819332	4017807508536
516	652310131	4017807427677	130	671310131	4017807451832	540	682410506	4017807280845
516	652310132	4017807504095	130	671310142	4017807445312	560	686014000	4017807507744
516	652410106	4017807427684	334	671610307	4017807391237	560	686014001	4017807507720
516	652410131	4017807427691	317	672310232	4017807503357	557	689214032	4017807507768
516	652410132	4017807504101	324	672610332	4017807441208	557	689314032	4017807507782
514	652510106	4017807427707	132	672910106	4017807299274	272	693900417	4017807409451
514	652510131	4017807427714	324	673210332	4017807441192	272	693900517	4017807399547
514	652510132	4017807504132	337	673311306	4017807358407	496	700131	4017807470161
514	652610106	4017807427721	302	673810206	4017807433333	496	700132	4017807470178
514	652610131	4017807427738	302	673810232	4017807433364	496	700187	4017807470246
514	652610132	4017807504156	302	673810306	4017807505689	496	700231	4017807470277
326	652610342	4017807453751	302	673810332	4017807505702	496	700232	4017807470307
326	652690342	4017807453768	302	673890206	4017807433371	496	700287	4017807470253
124	652710307	4017807453799	302	673890232	4017807433388	496	700331	4017807591033
124	652710342	4017807473339	304	673916007	4017807452594	496	700332	4017807591057
464	652910131	4017807473643	304	673916031	4017807452235	496	700387	4017807591071
464	652910132	4017807473650	304	673916032	4017807441437	497	701031	4017807470321
464	652910231	4017807473667	304	673918007	4017807452617	497	701032	4017807470338
464	652910232	4017807473674	304	673918031	4017807452259	497	701087	4017807470345
464	652910331	4017807473681	304	673918032	4017807441468	497	701131	4017807474824
464	652910332	4017807473698	342	674011207	4017807363708	497	701132	4017807474831
292	653210631	4017807614077	342	674013007	4017807363630	497	701187	4017807474848

Seite Page	Artikel-Nr. Product No.	EAN-Nummer EAN-Number	Seite Page	Artikel-Nr. Product No.	EAN-Nummer EAN-Number	Seite Page	Artikel-Nr. Product No.	EAN-Nummer EAN-Number
503	701231	4017807470352	506	73060132	4017807577518	474	802400365	4017807612394
503	701232	4017807470369	511	73120102	4017807471557	478	802400380	4017807523935
503	701287	4017807470376	507	73240107	4017807471564	476	802430401	4017807227574
498	702031	4017807470383	507	73240131	4017807471571	478	802430404	4017807490596
498	702032	4017807470390	507	73240132	4017807471588	476	802430407	4017807231397
498	702087	4017807470406	510	73430132	4017807506037	476	802430432	4017807408676
498	702131	4017807470475	506	73520101	4017807471656	474	802430465	4017807612400
498	702132	4017807470482	506	73700132	4017807577501	478	802430480	4017807523959
498	702187	4017807470499	508	76921031	4017807505962	70	803400167	4017807430196
498	702231	4017807470505	508	76921032	4017807505979	70	803400267	4017807430202
498	702231A	4017807474855	508	76921087	4017807505986	70	803400367	4017807430219
498	702232	4017807470543	508	77020131	4017807472028	482	803500132	4017807408225
498	702232A	4017807474862	508	77020132	4017807472035	482	803500232	4017807408249
498	702287	4017807470550	508	77020187	4017807472042	482	803500332	4017807408263
498	702287A	4017807474879	504	78030131	4017807505900	80	804300332	4017807467666
499	702331	4017807470567	504	78030132	4017807505917	80	804300334	4017807600506
499	702331A	4017807482171	504	78030187	4017807505924	80	804300432	4017807467680
499	702331B	4017807518900	504	78070107	4017807472073	80	804300434	4017807600513
499	702332	4017807470574	504	78070131	4017807472080	80	804370132	4017807467604
499	702332A	4017807482188	504	78070132	4017807472103	80	804370134	4017807600483
499	702332B	4017807518924	506	78170107	4017807471663	80	804370232	4017807467642
499	702387	4017807470581	507	78240107	4017807471694	80	804370234	4017807600490
499	702387A	4017807482195	507	78240131	4017807471700	268	811400132	4017807538335
499	702387B	4017807518948	507	78240132	4017807471724	268	811400232	4017807538359
499	702431	4017807470598	510	78330101	4017807471977	268	811400432	4017807538397
499	702432	4017807470604	510	78330111	4017807471991	268	811430332	4017807538373
499	702487	4017807470611	510	78330179	4017807472295	487	811700132	4017807581096
503	702531	4017807470628	510	78430132	4017807506020	487	811700232	4017807581102
503	702532	4017807470635	483	801100231	4017807562316	487	811700332	4017807581119
503	702587	4017807470642	483	801100232	4017807562217	486	812100106	4017807581126
502	703031	4017807471397	483	801100331	4017807565676	486	812100206	4017807581133
502	703032	4017807471403	483	801100332	4017807562231	486	812100306	4017807581140
502	703087	4017807471410	483	801170131	4017807585315	480	812400107	4017807487947
502	703131	4017807471427	483	801170132	4017807585339	480	812400131	4017807487961
502	703132	4017807471434	68	801900167	4017807502558	480	812400132	4017807487954
502	703187	4017807471441	68	801900267	4017807502565	480	812400207	4017807487978
502	703231	4017807471458	68	801900367	4017807502589	480	812400231	4017807487992
502	703232	4017807471465	476	802400101	4017807227543	480	812400232	4017807487985
502	703287	4017807471472	478	802400104	4017807490534	480	812400307	4017807488005
501	703331	4017807471489	476	802400107	4017807231335	480	812400331	4017807488029
501	703387	4017807471519	476	802400124	4017807408621	480	812400332	4017807488012
502	703431	4017807474886	476	802400132	4017807408614	480	812400407	4017807488036
501	703531	4017807474893	474	802400165	4017807612370	480	812400431	4017807488067
501	703532	4017807474909	478	802400180	4017807523898	480	812400432	4017807488043
501	703587	4017807474916	476	802400201	4017807227550	472	817100231	4017807613070
501	703631	4017807577471	478	802400204	4017807490558	472	817100232	4017807613063
501	703632	4017807577488	476	802400207	4017807231359	472	817100331	4017807613094
501	703687	4017807577495	476	802400224	4017807408645	472	817100332	4017807613087
502	703731	4017807591101	476	802400232	4017807408638	472	817100431	4017807613117
502	703732	4017807591118	474	802400265	4017807612387	472	817100432	4017807613100
502	703787	4017807591125	478	802400280	4017807523911	472	817170131	4017807627749
503	703809	4017807577525	476	802400301	4017807227567	472	817170132	4017807627725
502	703952	4017807471533	478	802400304	4017807490572	468	821410305	4017807220902
509	73043107	4017807505955	476	802400307	4017807231373	468	821410405	4017807220919
509	73043131	4017807505931	476	802400324	4017807408669	468	821430405	4017807220926
509	73043132	4017807505948	476	802400332	4017807408652	468	821470105	4017807220889

# INDEX · NUMERIC

Seite Page	Artikel-Nr. Product No.	EAN-Nummer EAN-Number	Seite Page	Artikel-Nr. Product No.	EAN-Nummer EAN-Number	Seite Page	Artikel-Nr. Product No.	EAN-Nummer EAN-Number
468	821470205	4017807220896	538	880430306	4017807508369	565	986-4813	4017807586725
462	849210131	4017807612585	538	880430332	4017807508376	564	986-60	4017807280647
462	849210132	4017807612622	391	891010107	4017807358049	566	986-6790	4017807509120
462	849210231	4017807612592	391	891010132	4017807600797	566	986-6810	4017807358766
462	849210232	4017807612639	391	8911211-07	4017807118780	565	987-2400	4017807303933
462	849210331	4017807612608	391	8911211-32	4017807600780	564	987-400	4017807287509
462	849210332	4017807612646	568	901-479	4017807351446	565	987-410	4017807394917
462	849210431	4017807612615	568	902-479	4017807351453	565	987-479	4017807509106
462	849210432	4017807612653	568	904-479	4017807351477	567	987-4813	4017807579123
484	862700176	4017807615715	573	929-220	4017807293319	564	987-60	4017807279252
484	862700276	4017807615722	573	929-230	4017807355000	567	987-600	4017807288056
484	862700376	4017807615739	573	929-2300	4017807394924	565	987-6700	4017807387636
484	862700476	4017807615746	61	92945	4017807478174	567	987-679	4017807288049
224	862800132	4017807615821	572	955-50	4017807277074	564	987-6810	4017807358735
224	862800232	4017807615838	572	956-330	4017807509151	564	987-7009	4017807508949
224	862800332	4017807615845	572	956-355	4017807509144	565	987-740	4017807579079
224	862800432	4017807615852	572	956-44	4017807579062	564	987-909	4017807508956
488	871010107	4017807281637	572	956-509	4017807508987	564	988-10	4017807300338
488	871010108	4017807281644	572	956-5736	4017807380057	564	988-110	4017807394894
488	871010207	4017807281651	572	956-5936	4017807380071	567	988-4813	4017807579147
488	871010208	4017807281668	570	983-3200	4017807508901	566	988-600	4017807287516
488	871010307	4017807281675	571	983-3200	4017807508901	566	988-679	4017807287530
488	871010308	4017807281682	570	983-3279	4017807508932	564	988-700	4017807394887
488	871010407	4017807281712	571	983-3279	4017807508932	567	988-710	4017807433449
488	871010408	4017807281729	569	983-40	4017807240566	566	988-901	4017807579093
488	871010607	4017807281736	571	983-400	4017807302097	569	989-40	4017807240597
488	871010608	4017807281743	570	983-410	4017807394900	570	989-400	4017807287486
488	871090307	4017807281699	571	983-440	4017807579086	570	989-4470	4017807358926
488	871090308	4017807281705	571	983-4470	4017807358940	570	989-479	4017807287523
470	873110331	4017807302622	571	983-479	4017807530612	570	989-4790	4017807509083
470	873110431	4017807302646	571	983-4790	4017807509137	569	989-509	4017807508970
470	873110631	4017807302660	571	983-4813	4017807579109	569	989-56	4017807394870
470	873170131	4017807302585	569	983-509	4017807508963	569	989-60	4017807279238
470	873170231	4017807302608	569	983-56	4017807394863	569	989-66	4017807300352
538	880400106	4017807508031	569	983-60	4017807279214	570	990-279	4017807508888
538	880400132	4017807508048	569	983-66	4017807300345	570	990-400	4017807287493
538	880400406	4017807508383	566	985-6810	4017807358759	570	990-4470	4017807358933
538	880400432	4017807508390	564	986-40	4017807268782	570	990-4790	4017807509076

(D)

Informationen zu Ersatzteilen finden Sie auf unserer Webseite. Die Suche nach dem passenden Ersatzteil wird durch die Eingabe der Modell- oder Typennummer erleichtert.

(NL)

Informatie over reserveonderdelen vind je op onze website. Het zoeken naar het juiste reserveonderdeel wordt vergemakkelijkt door het model- of typennummer in te voeren.

(RO)

Puteți găsi informații despre piesele de schimb pe site-ul nostru web. Căutarea piesei de schimb potrivite este facilitată prin introducerea numărului modelului sau al tipului.

(GB)

You can find information on spare parts on our website. The search for the right spare part is made easier by entering the model or type number.

(ES)

En nuestro sitio web encontrará información sobre piezas de recambio. La búsqueda de la pieza de recambio adecuada se facilita introduciendo el número de modelo o tipo.

(FI)

Löydät tietoa varaosista verkkosivuiltamme. Oikean varaosan etsimistä helpottaa mallin tai tyyppinumeron syöttäminen.

(FR)

Vous trouverez des informations sur les pièces détachées sur notre site web. La recherche de la bonne pièce détachée est facilitée par la saisie du numéro de modèle ou de type.

(IT)

Sul nostro sito web è possibile trovare informazioni sui pezzi di ricambio. La ricerca del ricambio giusto è facilitata dall'inserimento del numero del modello o del tipo.

(PL)

Informacje na temat części zamiennych można znaleźć na naszej stronie internetowej. Wyszukiwanie odpowiedniej części zamiennej jest łatwiejsze po wprowadzeniu numeru modelu lub typu.

# GARANTIEERKLÄRUNG

Warranty Statement · Déclaration de garantie · Garantieverklaring · Declaración de garantía · Dichiarazione di garanzia · Declarație de garanție · Takuuehdot · Oświadczenie o gwarancji



(D)

Als innovatives und zukunftsorientiertes Unternehmen legen wir großen Wert auf die Qualität und Zuverlässigkeit unserer Produkte. Alle unsere Sortimentsartikel unterliegen einer strengen Qualitätskontrolle. Sollte ein Produkt wider Erwarten nicht einwandfrei funktionieren oder Mängel aufweisen, übernehmen wir gegenüber Verbrauchern für alle LED-Leuchten mit fest verbauten LEDs eine freiwillige Funktionsgarantie von 5 Jahren. Nähere Informationen finden Sie in der Garantieerklärung auf unserer Internetseite.

[www.trio-leuchten.de](http://www.trio-leuchten.de)

(GB)

As an innovative, forward-thinking company, we place great value on the quality and reliability of our products. All the items in our range are subject to strict quality control. Should a product, contrary to expectations, show faulty function or defects, we provide consumers with a voluntary functional guarantee of 5 years for all LED luminaires with permanently installed LEDs. For further information, please visit our website.

[www.trio-lighting.com](http://www.trio-lighting.com)

(FR)

En tant qu'entreprise innovante orientée vers l'avenir, nous accordons une grande importance à la qualité et à la fiabilité de nos produits. Tous les articles de notre gamme sont soumis à des contrôles-qualité stricts. Si contre toute attente un produit devait ne pas fonctionner correctement ou présenter des vices, nous offrons aux consommateurs une garantie fonctionnement de 5 ans pour tous les luminaires disposant de LED permanentes. Pour plus d'information, consultez notre site.

[www.trio-lighting.com](http://www.trio-lighting.com)

(NL)

Als innovatieve en toekomstgerichte onderneming hechten wij veel belang aan de kwaliteit en betrouwbaarheid van onze producten. Alle artikelen uit ons assortiment worden onderworpen aan een strenge kwaliteitscontrole. Indien een product tegen de verwachting in niet foutloos functioneert of gebreken vertoont, bieden wij consumenten een vrijwillige fabrieksgarantie van 5 jaar op alle verlichtingstoestellen met permanent geïnstalleerde leds. Voor meer informatie, consulteer onze website.

[www.trio-lighting.com](http://www.trio-lighting.com)

(ES)

Como empresa innovadora y con la vista puesta en el futuro, le damos una gran importancia a la calidad y la fiabilidad de nuestros productos. Todos los artículos de nuestro catálogo están sujetos a un estricto control de calidad. En aquellos casos en los que, contrariamente a lo previsto, un producto presente algún defecto o un funcionamiento deficiente, ofrece a los usuarios una garantía funcional de 5 años en todos sus artículos de iluminación que cuentan con luces LED instaladas. Para más información, por favor visite nuestra página web.

[www.trio-lighting.com](http://www.trio-lighting.com)

(IT)

In quanto azienda orientata all'innovazione e proiettata nel futuro, riponiamo un grande valore nella qualità e nell'affidabilità dei nostri prodotti. Tutti gli articoli del nostro assortimento vengono sottoposti a un rigido controllo della qualità. Nel caso in cui un prodotto dovesse presentare, contro ogni aspettativa, malfunzionamenti o difetti, offriamo ai consumatori una garanzia di funzionamento facoltativa di 5 anni per tutti gli apparecchi LED installati in modo permanente. Per ulteriori informazioni, vi preghiamo di visitare il nostro sito web.

[www.trio-lighting.com](http://www.trio-lighting.com)

(RO)

În calitate de companie inovatoare și orientată spre viitor punem mare accent pe calitatea și siguranța produselor noastre. Toate sortimentele noastre sunt supuse unui control riguros de calitate. Dacă un produs nu funcționează ireproșabil conform așteptărilor sau prezintă defect, vă oferim consumatorilor o garanție voluntară operațională de 5 ani pentru toate de iluminat cu LED-uri permanent instalate. Pentru mai multe detalii, vă rugăm să vizitați site-ul.

[www.trio-lighting.com](http://www.trio-lighting.com)

(FI)

Innovatiivisena ja tulevaisuuteen katsovana yrityksenä kiinnitämme erityistä huomiota tuotteidemme laatuun ja luotettavuuteen. Kaikki valikoimamme tuotteet ovat tiukan laadunvalvonnan alaisia. Siltä varalta, että tuotteemme ei vastoin odotuksia toimikaan moitteettomasti tai siinä on vikoja, myöntää kuluttajille vapaaehtoisien 5 vuoden toimintakuun kaikille pysyvästi asennetuille LED-valoille.

Lisätietoja verkkosivuiltamme.

[www.trio-lighting.com](http://www.trio-lighting.com)

(PL)

Jako innowacyjne i ukierunkowane na przyszłość przedsiębiorstwo przykładamy dużą wagę do jakości i niezawodności naszych produktów. Wszystkie artykuły z naszego asortymentu poddawane są surowej kontroli jakości. Jeśli produkt mimo oczekiwań nie działa prawidłowo lub jest uszkodzony, oferujemy dobrowolną 5-letnią gwarancję funkcjonalną na wszystkie oprawy oświetleniowe z zamontowanymi na stałe diodami LED. Na naszej stronie internetowej może Państwo uzyskać więcej informacji na ten temat.

[www.trio-lighting.com](http://www.trio-lighting.com)

# KONTAKTE

Contact · Contact · Contact · Contactar · Contatto · Contact · Yhteydenotto · Kontakt

## **TRIO Leuchten GmbH**

Gut Nierhof 17  
D-59757 Arnsberg

T +49 (0) 2931 9666-0  
F +49 (0) 2931 9666-57

info@trio-leuchten.de  
www.trio-leuchten.de

## **Reality Leuchten GmbH**

Gut Nierhof 17  
D-59757 Arnsberg

T +49 (0) 2931 9666-99  
F +49 (0) 2931 9666-98

info@reality-leuchten.de  
www.reality-leuchten.de

## **TRIO International GmbH**

Gut Nierhof 17  
D-59757 Arnsberg

T +49 (0) 2931 9666-587  
F +49 (0) 2931 9666-56

info@trio-lighting.com  
www.trio-lighting.com

## **Baden Württemberg, Rheinland-Pfalz und Saarland**

### **Antonio De Simone**

T +49 (0) 151 58555222  
antonio.desimone@trio-leuchten.de

## **Bayern, Hessen**

### **Martin Kluge**

T +49 (0) 171 7300330  
martin.kluge@trio-leuchten.de

## **Berlin, Brandenburg, Mecklenburg-Vorpommern, Sachsen, Sachsen-Anhalt, Thüringen**

### **Jörg Bumke**

T +49 (0) 160 7406860  
joerg.bumke@trio-leuchten.de

## **Bremen, Hamburg, Niedersachsen, Schleswig-Holstein**

### **Jens Gebers**

T +49 (0) 170 1615227  
jens.gebers@trio-leuchten.de

## **Hessen, Nordrhein-Westfalen Rheinland-Pflaz**

### **Christian Teller**

T +49 (0) 171 4521820  
christian.teller@trio-leuchten.de

## **Österreich**

### **Wolfgang Melich**

T +43 (0) 660 5161228  
wolfgang.melich@trio-leuchten.de

## **Schweiz**

### **Reality Leuchten GmbH**

T +49(0)2931 9666 99  
info@reality-leuchten.de

## **France**

### **Stéphane Papierny**

Directeur Comerciale France  
info.france@trio-lighting.com

### **Julien Lamouret**

Product & Sales Manager DIY France

### **Sullivan Nicolas**

Commercial pour les départements  
01, 03, 07, 21, 23, 26, 38, 39, 42, 43, 48, 63,  
69, 71, 73 et 74

### **Vincent Zaepffel**

Commercial pour les départements  
08, 10, 25, 51, 52, 54, 55, 57, 67, 68, 70,  
88 et 90

### **Christophe Meulien**

Agent commercial pour les départements  
04, 05, 06, 11, 13, 30, 34, 66, 83, 84 et 98

### **Jean Barel**

Agent exclusif pour les départements  
09, 12, 15, 16, 19, 24, 31, 32, 33, 40, 46, 47,  
64, 65, 81, 82 et 87

### **Michel Salamand**

Agent commercial pour les départements  
14, 17, 22, 29, 35, 36, 37, 41, 44, 49, 50, 53, 56,  
61, 72, 79, 85 et 86

### **Stéphane Riebel**

Agent commercial pour les départements  
18, 27, 28, 45, 58, 75, 76, 77, 78, 89, 91, 92, 93,  
94 et 95

### **Sylvain Martin**

Agent commercial pour les territoires  
des DOMTOM

### **Bruno Rouquié**

Agent commercial pour les départements  
09, 12, 15, 16, 19, 24, 31, 32, 33, 40, 46, 47,  
64, 65, 81, 82 et 87

### **Matthieu Soubiran**

Agent commercial pour les départements  
02, 59, 60, 62 et 80

### **Jean Marc Beneforti**

Agent commercial pour les départements  
2a et 2b

## **Belgium**

**Yves Van den Berghe / Frank Boesmans/  
Pauline Delorme**

info.belgium@trio-lighting.com



## Denmark

### Jan Rantzau-Bartens

info.denmark@trio-lighting.com

## Netherlands

### Karl Stok / Bas Martin

info.nederland@trio-lighting.com

## Romania

### Loredana Barbu

info.romania@trio-lighting.com

## Great Britain

### TRIO Lighting UK Ltd.

Unit 5, Hemmells Park Hemmells,

Laindon Essex

SS1s 6GF

T +44 (0) 12 68 88 95 95

F +44 (0) 12 68 88 95 96

sales@trio-lightinguk.com

## Italy

### TRIO Lighting Italia s.r.l

Via Isonzo, 81

22066 Mariano Comense (CO)

T +39 (0) 317 477 55

F +39 (0) 313 551 560

commerciale@trio-lighting.com

## Nordic and Baltic

### TRIO Lighting Scandinavia Oy

Malmin raitti, rappu 17 B

00700 Helsinki

T +358 (0) 10 23 13 390

TLS@trio-lighting.com

*Our Scandinavian organisation represents TRIO also in Estonia, Iceland, Latvia, Lithuania, Norway and Sweden*

## Spain

### TRIO Lighting Ibèrica S.L.

C/VALLESPÍR 19, Plta 2, mòdulo 1.1

08173 Sant Cugat del Vallès

T +34 (0) 935 458 630

info.iberica@trio-lighting.com

## Africa

### F&M Global

T (+32) 4719 22111

hans.deserranno@fmglobal.be

### Ina Concept

T (+32) 4719 94693

jerome.freri@ina-concept.com

## Albania

### Kika Light

T (+355) 672 084 781

kikallight@gmail.com

## Bosnia and Herzegovina

### GRIČ d.o.o.

T (+38) 7039 706 658

daniel.martinovic@tel.net.ba

## Bulgaria

### ATG Bulgaria

T (+359) 899 927 707

deyana\_petrova@atg-apa.net

## Czech Republic

### Luminex spol. s.r.o.

T (+42) 777 570 560

objednavky@luminex.cz

## Greece / Cyprus

### Solomon Lighting S.A.

T (+30) 21060 46003

alberto@solomongroup.gr

## Hungary

### Luxera Kft.

T (+36) 83 3163 88

info@trio-lampa.hu

## Kosovo

### ACN

T (+383) 44 344 434

info@acn-ks.com

## North Macedonia

### Elektro Megavat

T (+389) 71665006

contact@megalight.com.mk

## Polen

### Delighting Polska sp. z.o.o.

T (+48) 61 4367 481

kontakt@delighting.pl

## Republic of Moldova

### Volta LTD

T (+37) 322 26 7775

import5@volta.md

## Serbia

### Aura Light d.o.o. Novi Sad

T (+38) 121 2100724

aura.lightdoo@gmail.com

## Slovakia

### Feim SK s.r.o.

T (+42) 134 7743 228

svietidla@feim.sk

## Slovenia

### BT Trade d.o.o.

T (+386) 41 676 006

info@butiksvetil.si

## Turkey

### Soho Aydinlatma Ticaret Ltd.

T (+90) 2165 7669 41

kartal.kendirici@soholight.com

## Ukraine

### MAX Light

T (+38) 4446 37942

tanya@maxlight.ua

# SAVE THE DATE



**LICHTWOCHE**  
**SAUERLAND**  
16.02. – 21.02.2025

lichtforumnrw

Mitglied der Trägergesellschaft Lichtforum NRW e.V.  
Member of the supporting organisation Lichtforum NRW e.V.

TRIO behält sich das Recht vor, zu jeder Zeit, notwendige Änderungen oder Aktualisierungen der in diesem Katalog enthaltenen Produkte vorzunehmen. · TRIO reserves the right to carry out any time, necessary changes or updates of the products in this catalogue. · TRIO se réserve le droit d'apporter à tout moment les modifications ou actualisations nécessaires aux produits dans ce catalogue. · TRIO behoudt zich het recht voor op ieder moment noodzakelijke wijzigingen of updates aan de producten in deze catalogus door te voeren. · TRIO se reserva , en todo momento, el derecho a realizar las modificaciones o actualizaciones que considere necesarias para cualquier producto de este catálogo. · TRIO si riserva il diritto di apportare, in qualunque momento, tutte le modifiche necessarie ai prodotti di questo catalogo. · TRIO-ul își rezervă dreptul de a face oricând orice modificări sau actualizări necesare pentru produsele din acest catalog. · TRIO pidättää oikeuden tehdä muutoksia tai päivittää tuotteita tässä luettelossa. · TRIO zastrzega sobie prawo do wprowadzania w dowolnym czasie zmian lub aktualizacji produktów zawartych w katalogu.





**TRIO Leuchten GmbH**

Gut Nierhof 17  
D-59757 Arnsberg  
T +49 (0) 2931 9666-0  
F +49 (0) 2931 9666-28  
info@trio-leuchten.de  
www.trio-leuchten.de

**TRIO International GmbH**

Gut Nierhof 17  
D-59757 Arnsberg  
T +49 (0) 2931 9666-587  
F +49 (0) 2931 9666-56  
info@trio-lighting.com  
www.trio-lighting.com



LIGHTING FOR YOU